

CONTROLLER 48x48mm

RE70 TYPE

USER'S MANUAL



Contents:

1. Application	3
2. Controller set	3
3. Basic requirements, operational safety	3
4. Installation	4
4.1. Controller installation.....	4
4.2. Electrical connections.....	4
4.3. Recommendations for installation.....	5
5. Starting work	6
6. Service	7
6.1. Programming Controller Parameters.....	7
6.2. Programming matrix.....	8
6.3. Setting Change.....	8
6.4. Parameters description.....	8
7. Inputs and outputs of the controller	10
7.1. Inputs.....	10
7.1. Output.....	11
8. Control	11
7.1. ON-OFF algorithm.....	11
7.2. Innovative SMART PID algorithm.....	12
9. Alarms	14
10. Additional functions	14
10.1. Displaying the control signal.....	14
10.2. Manual mode.....	14
10.3. Defaults Settings.....	15
11. RS-485 interface with MODBUS protocol	15
11.1. Introduction.....	15
11.2. Error codes.....	15
11.3. Register map.....	15
12. Error signaling	17
13. Technical data	18
14. Controller ordering code	19

1. Application

The RE70 controller is destined for the temperature control. Controller works directly with the resistance sensors or thermoelectric sensors.

The controller is equipped with one output that allows for dual-point control and alert signalization. Dual-point control is based on the PID or ON/OFF algorithm. Relay output is equipped with a switchable contact and allows for indirect control of the low-power objects.

The innovative SMART PID algorithm has been implemented in the controller.

2. Controller set

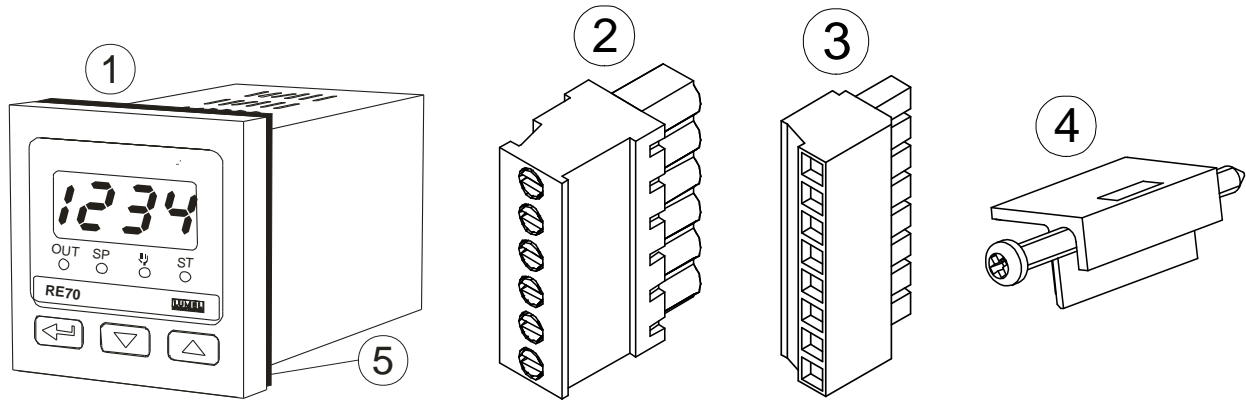

Complete set of the controller includes:

1. controller 1 pc
2. plug with 6 screw terminals..... 1 pc
3. plug with 8 screw terminals..... 1 pc
4. holders to fix the meter in the panel..... 4 pcs
5. seal 1 pc
6. user's manual 1 pc
7. guarantee card..... 1 pc

3. Basic requirements, operational safety

In terms of operational safety the controller meets the requirements of the EN 61010-1 standard.

Comments concerning safety:



- Assembly and installation of the electrical connections should be conducted only by people authorised to perform assembly of electric devices.
- Always check the state of connections before turning the controller on.
- Prior to taking the controller housing off, always turn the supply off and disconnect measuring circuits.
- Removal of the controller housing during the warranty period voids the warranty.
- The device is designed for installation and usage in the industrial electromagnetic environment.
- The installation should have a switch or a circuit-breaker installed. This switch should be located near the device, easily accessible by the operator and suitably marked.

4. Installation

4.1. Controller installation

Fix the controller to the board with four screw brackets as shown in the fig. 1. A slot in the panel must have the dimensions $45^{+0,6} \times 45^{+0,6}$ mm. The thickness of the panel material cannot exceed 15 mm.

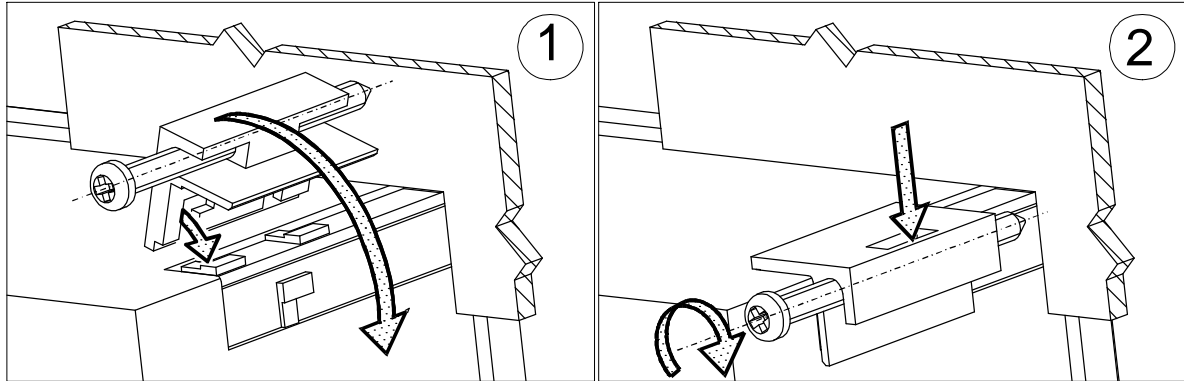

Fig. 1. Controller installation.

Dimensions of the controller are presented on the fig. 2.

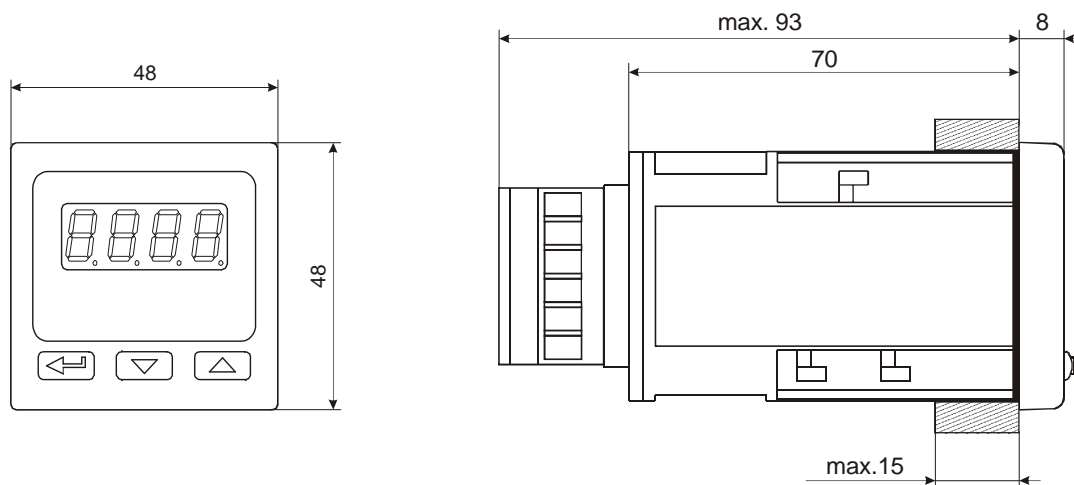

Fig. 2. Controller dimensions.

4.2. Electrical connections

The controller has two separate connectors with screw terminals. One strip enables the connection of the supply and outputs by a wire of $2,5 \text{ mm}^2$, the second strip enables input signal connections by a wire of $1,5 \text{ mm}^2$.

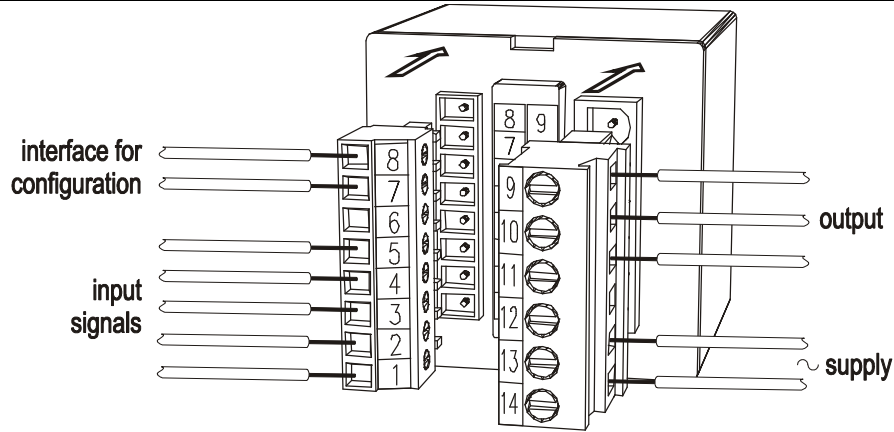

Fig. 3. View of the controller's connection strips.

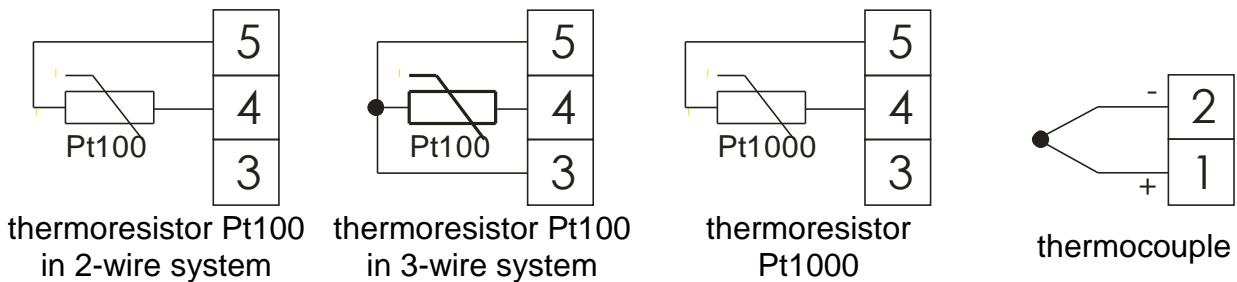

Fig. 4. Input signals

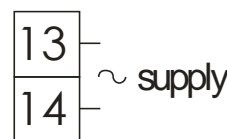

Fig. 5. Supply

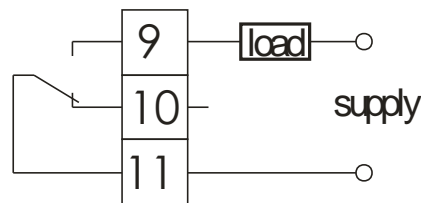

Fig. 6. Control/Alarm output

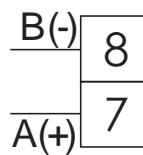

Fig. 7. RS-485 interface (only for configuration)

4.3. Recommendations for installation

To achieve full electromagnetic resistance of the controller, it is necessary to follow the rules described below:

- do not supply the controller from the network in the proximity of devices generating high pulse noises and do not apply common earthing circuits,
- apply network filters,
- wires leading measuring signals should be twisted in pairs, and for resistance sensors in 3-wire connection, twisted of wires of the same length, cross-section and resistance, and led in a shield,
- all shields should be one-side earthed or connected to the protection wire, the nearest possible to the controller,

- as a rule of thumb, wires transmitting different signals should be spaced as far as it is possible (at least 30 cm) and should be crossed only at the right angle of 90°.

5. Starting work

Controller description

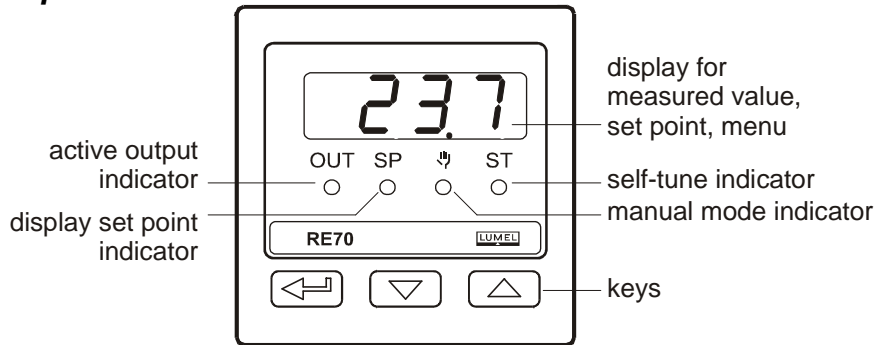

Fig. 8. Overview of the controller's front panel.

Switching a supply on

After powering on, the controller performs the display test, displays **RE 70** text, software version and the measured value.

Display may also show an error message (see table 11).

The ON-OFF control algorithm with hysteresis given in the table 2 is set by the defaults.

Change of the set point

Set point is displayed after or buttons are pressed, this is accompanied by SP diode switching on. To change the set point, press or buttons again (fig. 9). The beginning of the change is signaled by pulsing dot symbol on the display. New set point must be accepted with a button within 30 seconds after the or button have been pressed, otherwise regulator will display set point with previously set point.

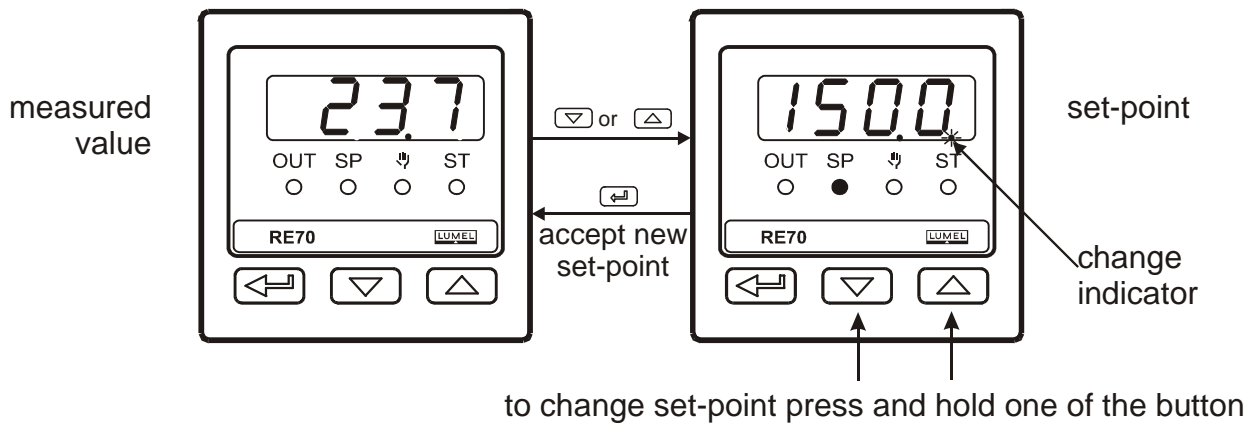

Fig. 9. Change value of the set point.

6. Service

The controller service is presented on the fig. 10.

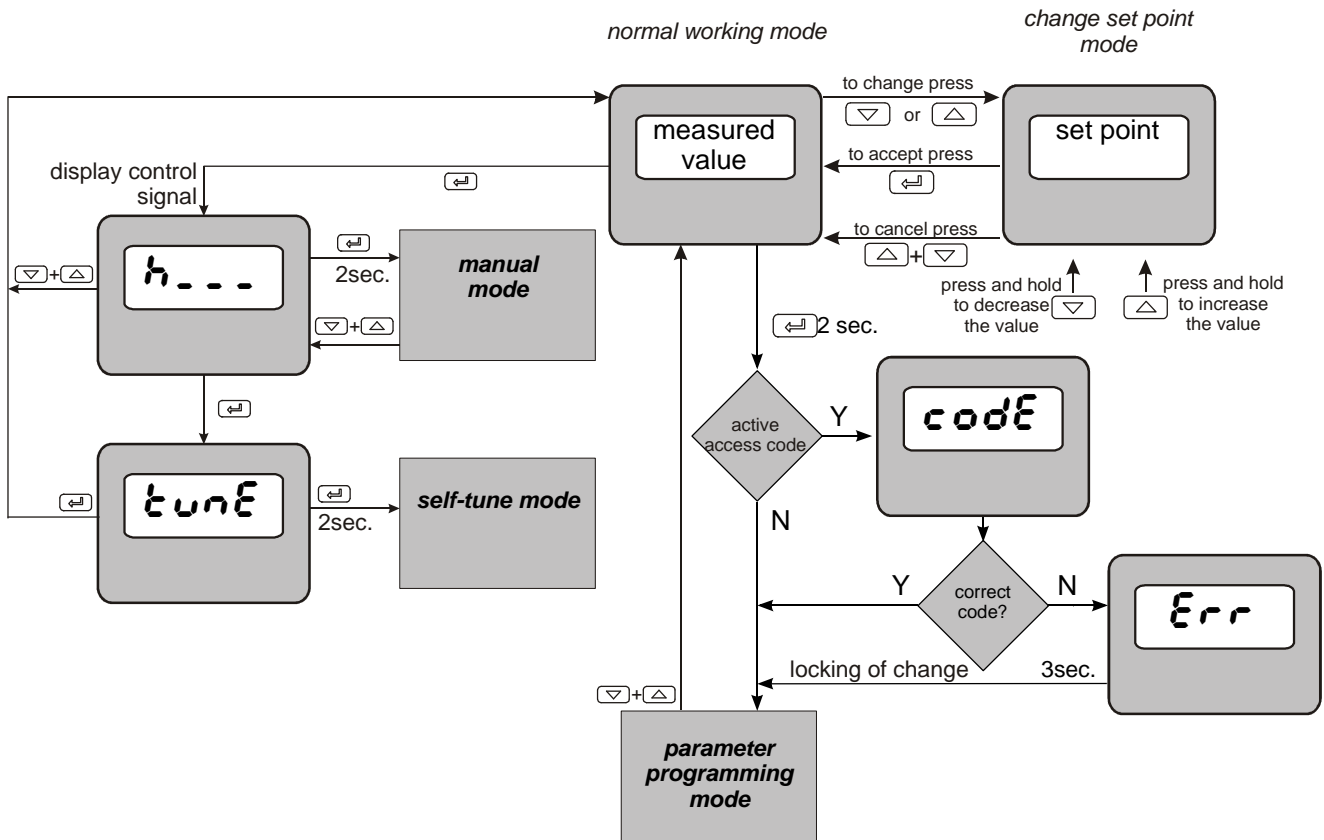

Fig. 10. Menu of controller service

6.1. Programming Controller Parameters

Pressing and holding down during ca 2 seconds the button causes the entry to the programming matrix. The programming matrix can be protected by an access code. In case when giving a wrong value of the code, it is only possible to see settings through - without possibility of changes.

Fig. 11 presents the transition matrix in the programming mode. The transition between levels is carrying out by using the buttons or and the level selection by using the button . After selecting the level, the transition between parameters is carried out by using the buttons or . In order to change the parameter setting proceed acc. to the section 6.3. In order to exit from the selected level, transit between parameters until appears the symbol [. .] and press the button . In order to exit from the programming matrix to the normal working mode, transit between levels until appears the symbol [. .] and press the button .

Some controller parameters can be invisible – it depends on the current configuration. The description of parameters shows the table 1. The return to the normal working mode follows automatically after 30 seconds since the last button pressure.

6.2. Programming matrix

inp Input parameters	unit Unit	inty Input type	tyli Type of line	shif Shift of measured value	dP Position of decimal point	...
outP Output parameters	out Output configuration	...				↶ Transition to the higher level
ctrl Control parameters	ALG Control algorithm	tyPE Type of control	HY Hysteresis	StLo Lower threshold for self-tuning	StHi Upper threshold for self-tuning	...
Pid PID Parameters	Pb Proportional band	ti Integral time constant	td Derivative time constant	YD Correction of control signal, for P or PD control	to Pulse period	↶ Transition to the higher level
ALAR Alarms parameters	ALSP Set point for the absolute alarm	ALdu Deviation from the set point of the relative alarm	ALHY Alarm hysteresis	...		↶ Transition to the higher level
SPP Set point parameters	SPL lower limitation of the set point setting	SPH upper limitation of the set point setting	...			↶ Transition to the higher level
SERu Service parameters	SECU Access code	SEFn Self-tuning function	...			↶ Transition to the higher level
...						↶ Exit from the menu

Fig. 11. Programming matrix

6.3. Setting Change

The change of parameter setting begins after pressing the button during the display of the parameter name. The setting selection is carried out through the buttons and and accepted by the button . The change cancellation follows after the simultaneous pressure of the buttons and or after 30 seconds since the last button pressure. The way to change the setting is shown on the fig. 12.

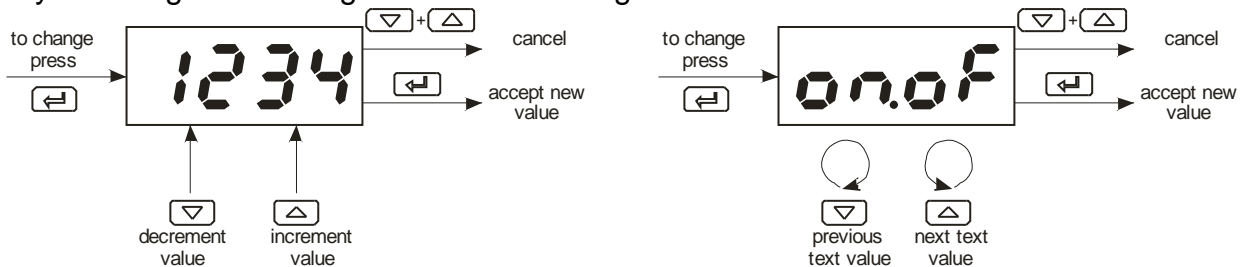

Fig. 12. Setting change of number and text parameters.

6.4. Parameters description

The list of parameters is presented in the table 1.

List of configuration parameters

Table 1

Symbol of parameter	Parameter description	Default setting	Range of parameter change
inp – Input parameters			
unit	Unit	°C	°C: degrees Celsius °F: degrees Fahrenheit
intty	Input type	Pt100	Pt100: Pt100 Pt1000: Pt1000 J: J type thermocouple T: T type thermocouple K: K type thermocouple S: S type thermocouple R: R type thermocouple B: B type thermocouple N: N type thermocouple
line	Line type for the sensor Pt100	2-P	2-P: 2-wire 3-P: 3-wire
dp	Position of the decimal point	1-dp	0-dp: without a decimal place 1-dp: 1 decimal place
shift	Shift of measured value	0.0 °C (0.0 °F)	-100.0...100.0 °C (-180.0...180.0 °F)
out – Output parameters			
out	Output configuration	Y	OFF: control off Y: control signal RH: upper absolute alarm RL: lower absolute alarm dRH: upper relative alarm dRL: lower relative alarm dwn: internal relative alarm duou: external relative alarm
ctrl – Control parameters ¹⁾			
ALG	Control algorithm	onof	onof: ON-OFF control algorithm PID: PID control algorithm
type	Type of control	dir	dir: direct control (cooling) rev: reverse control (heating)
HY	Hysteresis ⁴⁾	2.0 °C (3.6 °F)	0.2...100.0 °C (0.2...180.0 °F)
StLo	Lower threshold for self-tuning	0.0 °C (32.0 °F)	MIN...MAX ⁶⁾
StHi	Upper threshold for self-tuning	800.0 °C (1,472.0 °F)	MIN...MAX ⁶⁾
PID – PID parameters ²⁾			
Pb	Proportional band	30.0 °C (540.0 °F)	0.1...550.0 °C (0.1...990.0 °F)

Symbol of parameter	Parameter description	Default setting	Range of parameter change
t_i	Integral time constant	300	0...9999 s
t_d	Derivative time constant	60.0	0.0...2500 s
y_0	Correction of control signal, for P or PD control	0.0	0...100.0 %
t_o	Pulse period	20.0	0.5...99.9 s
ALAr – Alarms parameters ³⁾			
ALSP	Set point for the absolute alarm	0.0 °C (32.0 °F)	MIN...MAX ⁶⁾
ALdu	Deviation from the set point of the relative alarm	0.0 °C (0.0 °F)	-200,0... 200,0 °C (-360.0...360.0 °F)
ALHY	Hysteresis for the alarm	2.0 °C (3.6 °F)	0.2...100.0 °C (0.2...180.0 °F)
SPP – Set point parameters			
SPL	Lower limitation of the set point setting	-200.0 °C (-3,280.0 °F)	MIN...MAX ⁶⁾
SPH	Upper limitation of the set point setting	1,767.0 °C (3,212.6 °F)	MIN...MAX ⁶⁾
SErP – Service parameters			
SECU	Access code ⁵⁾	0	0...9999
SEFn	Self-tuning function	on	off : locked on : available

¹⁾ Group of parameters visible only when setting the output on the control signal.

²⁾ Group of parameters visible only when setting the control algorithm on PID.

³⁾ Group of parameters visible only when setting the output on one of the alarm.

⁴⁾ Parameter visible only when setting the control algorithm on ON-OFF.

⁵⁾ Parameter hidden in the monitoring mode of parameters only for readout.

⁶⁾ See table 2.

Range limits for inputs

table 2

Input / sensor	MIN		MAX	
	°C	°F	°C	°F
Thermoresistor Pt100	-200 °C	-328 °F	850 °C	1,562 ° F
Thermoresistor Pt1000	-200 °C	-328 °F	850 °C	1,562 °F
J type thermocouple	-50 °C	-58 °F	1,200 °C	2,192 °F
T type thermocouple	-50 °C	-58 °F	400 °C	752 °F
K type thermocouple	-50 °C	-58 °F	1,372 °C	2,501.6 °F
S type thermocouple	0 °C	32 °F	1,767 °C	3,212.6 °F
R type thermocouple	0 °C	32 °F	1,767 °C	3,212.6 °F
B type thermocouple	0 °C	32 °F	1,767 °C	3,212.6 °F
N type thermocouple	-50 °C	-58 °F	1,300 °C	2,372 °F

7. Inputs and outputs of the controller

7.1. Inputs

Input is the source of the measured value used for control or for alarms. The input is universal and the sensors Pt100, Pt1000 or thermocouples can be connected to it.

Start by using a **unit** parameter to set the temperature display unit. Unit change resets the value to the factory settings, with a different value ranges for Celsius and Fahrenheit scale.

Input signal is selected with a **input** parameter.

For the Pt100 thermoresistor, choose the **type** connection type - 2-wire or 3-wire. In the 3-wire Pt100 connection, resistance compensation is automatic.

For thermocouples, a cold terminal compensation is automatic.

Position of the decimal point is a additional parameter that determines display format of measured value and set point; it is set by the **dp** parameter. Correction of the indicated measured value is determined by the **sh, f** parameter.

7.1. Output

The controller has one output. It is possible to choose the following output options: on-off control, proportional control (PID) or alert. It is necessary to set the pulse period for the proportional control.

Pulse period is a time between two subsequent input engagements during proportional control. Pulse period length should be adjusted for the dynamic properties of the object and characteristics of the output device. It is recommended to use SSR transmitter for quick processes. Relay output is used for a contactor control in the slow-changing processes. Long pulse periods for quick-change processes may cause unnecessary oscillation. In theory, the shorter pulse period is, the better the control, however for the relay output a period should be as large, as possible to optimize lifespan of the relay.

Pulse period setting recommendations

Table 3

Output	Pulse period is	Load
electromagnetic transmitter	recommended >20s min. 10 s	5 A/230 VAC or a contactor
	min. 5 s	2 A/230 VAC

8. Control

7.1. ON-OFF algorithm

When high accuracy of a temperature control is not required, especially for the high time constant and small delay, it is possible to use ON-OFF control with hysteresis. Disadvantage of this method is the occurrence of oscillations, even at small hysteresis values.

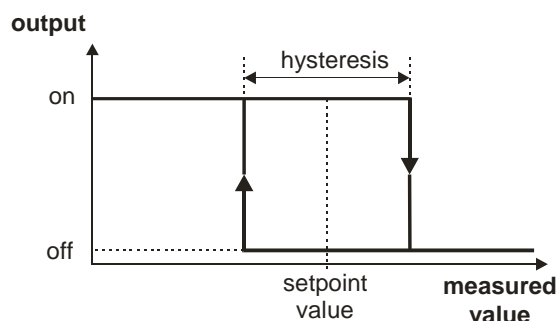

Fig. 13. Operation way of the heating type output for the ON-OFF control.

7.2. Innovative SMART PID algorithm

When high precision of the temperature control is necessary, it is recommended to use PID algorithm. Innovative SMART PID algorithm ensures increased precision in the extended range of the control object classes.

Tuning of the controller to object is achieved by automatically selected PID parameters using the self-tuning function or manual setting the value of the proportional element, integral element and derivative element.

7.2.1. Self-tuning

The controller has the function to select PID settings. In most cases these settings ensure an optimal control.

To begin the self-tuning, transit to the **tune** message (acc. to the fig. 10) and hold down the button  during at least 2 sec. If the control algorithm is set on ON-OFF or the self-tuning function is locked, then the tune message **tune** is hidden.

For a correct realization of the self-tuning function, it is required to set the parameters **SetLo** and **SetHi**. The parameter **SetLo** should be set on the value corresponding to the measured value at the switched off control. For object temperature control, you can set 0°C. The parameter **SetHi** should be set on the value corresponding to the maximum measured value when the control is switched on the full power.

The flickering AT symbol informs about the activity of the self-tuning function. The duration of self-tuning depends on dynamic object properties and can last maximally 10 hours. During self-tuning or directly after it, over-regulations can occur and because of this, one must set a smaller set point if possible.

The self-tuning is composed of following stages:

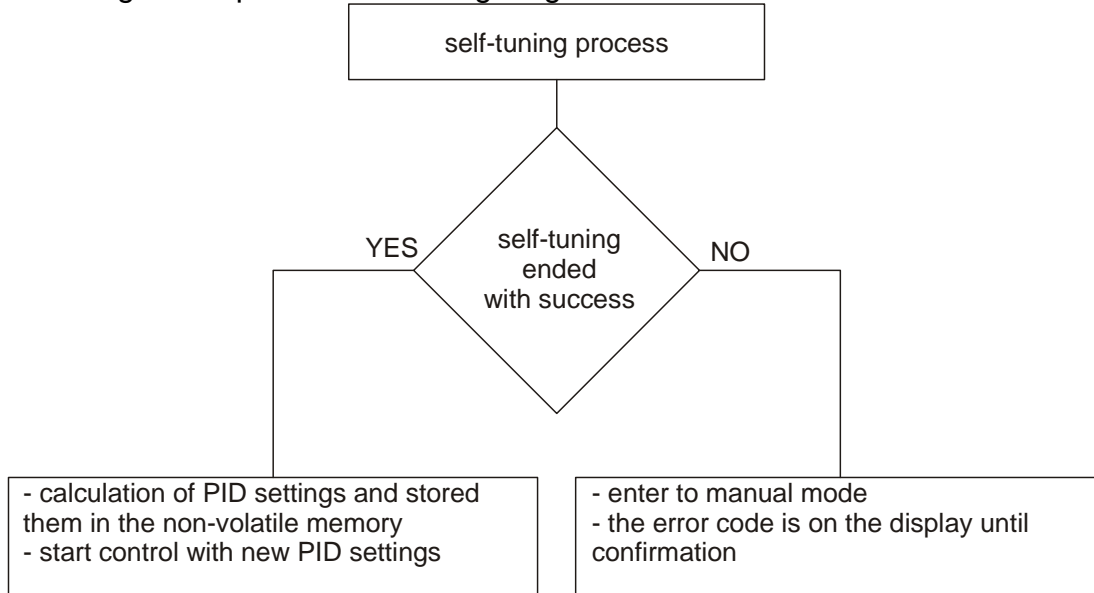

The self-tuning process will be stopped without counting PID settings, if a supply decay occurs or the button  will be pressed. In this case, the control with current PID settings will be started.

If the self-tuning experiment does not end with success, then an error code will be displayed, acc. to the table 4.

Error codes for self-tuning function

Table 4

Error code	Reason	Procedure
E501	P or PD control was selected.	One must choose PI, PID control, i.e. the TI unit must be higher than zero.
E502	The set point is incorrect.	Change temperature set point or the parameters <i>SetLo</i> , <i>SetHi</i> .
E503	The button  was pressed.	
E504	The maximal self-tuning duration time has been exceeded.	Check, if the temperature sensor is correctly situated, if the set point value is not set too higher for the given object.
E505	The waiting time of switching has been exceeded.	
E506	The input range limit has been exceeded.	Take note of the way to connect the sensor. Do not allow that the overflow results in exceeding of the input range limit.
E520	Very non-linear object, enabling to obtain correct values of PID parameters, or an interference has occurred.	Carry out the self-tuning again. If that does not help, choose PID parameters manually.

7.2.2. Proceeding in case of a unsatisfactory PID control

It is recommended to choose PID parameters, changing the value in a twice higher or twice less. During the change, one must respect following principles.

- a) Free jump response:
 - decrease the proportional band,
 - decrease the integral and derivative time.
- b) Over-regulations
 - increase the proportional band,
 - increase the derivative time,
- c) Oscillations
 - increase the proportional band,
 - increase integral time,
 - decrease the derivative time,
- d) Instability
 - increase the integral time.

9. Alarms

The controller output can be configured as an alarm output. For this, set the parameter **out** as one of alarms. Available types of alarms are given on the figure 14.

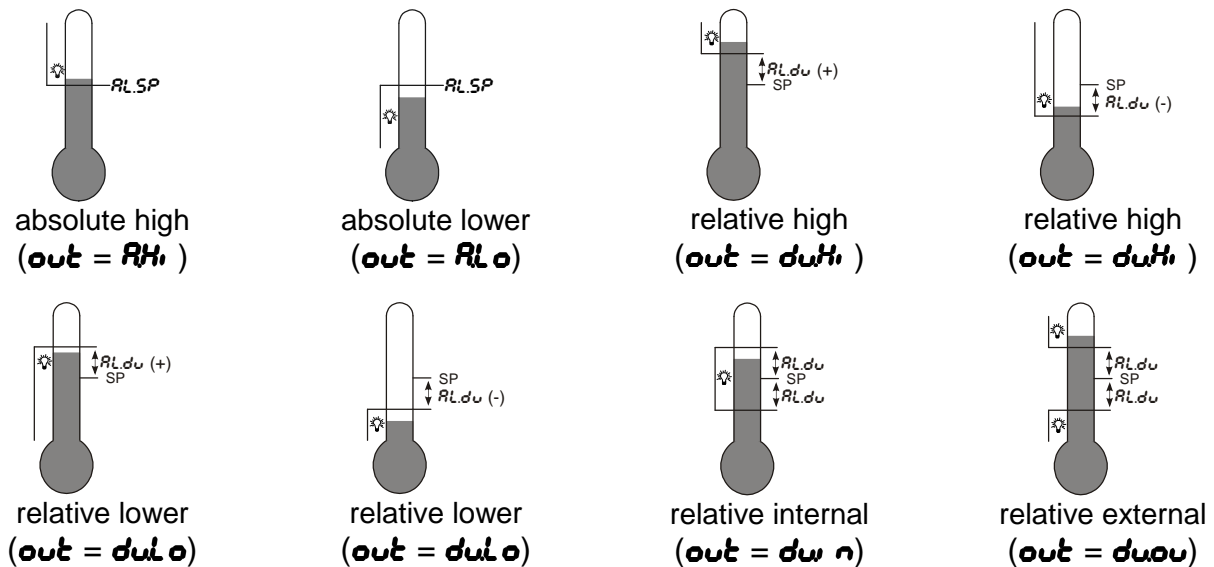



Fig.14. Types of alarms

The set point for absolute alarms is the value defined by the parameter **RL.SP**, and for relative alarms, it is the deviation from the set point - the parameter **RL.du**. Alarm hysteresis, the zone around the set point in which the input state is not changed is defined by the **RL.HY** parameter.



10. Additional functions



10.1. Displaying the control signal



After pressing the button  the value of the control signal (0...100%) is displayed on the display. On the first digit the h mark is displayed. Control signal can be displayed when the **out** parameter is set on **3**.



10.2. Manual mode

The manual mode gives the possibility to identify, test the object, or control it after a sensor damage.



The entry to the manual mode follows after holding down the button  during the control signal is display. The manual mode is signaled by the pulsation of the diode with the symbol . The controller interrupts the automatic control and begins the manual mode of the output. The control signal value is on the display, preceded by the symbol h.

For the ON-OFF control – the control signal can be set up by the buttons  and  at 0% or 100%.

For the PID control – the control signal can be set up by the buttons  and  at any optional value from the 0.0...100% range.

The exit to the normal work mode follows after pressing simultaneously the buttons  and .

10.3. Defaults Settings

Defaults settings can be restored during the supply connection by holding down the buttons  and  till the moment when the inscription **FRbr** appears on the display.

11. RS-485 interface with MODBUS protocol

11.1. Introduction

RE70 controller is equipped with RS-485 serial interface with implemented MODBUS asynchronous communication protocol. The interface is designed for controller configuration prior to using it.

Summary of the RE70 controller serial interface:

- device address: 1,
- baud rate: 9600 bit/s,
- operation modes: RTU,
- information unit: 8N2,
- data format: integer (16 bits)
- maximum response time: 500 ms,
- maximum number of registers read/written in one command: 32.

RE70 controller uses following protocol functions:

Table 5

Code	Meaning
03	n-registers read
06	1 register write
16	n-registers write
17	slave device identification

11.2. Error codes

If the controller receives query with the transmission error or checksum error, then such query will be ignored. When a query with correct syntax and invalid values is found, the controller returns an error code.

Table 6 shows error codes and their meaning.

Error codes

Table 6

code	meaning	reason
01	illegal function	function is not handled by the controller
02	illegal data address	register address out of range
03	illegal data value	register value out of range or register is readout only

11.3. Register map

In the controller, data are placed in 16-bit registers. The list of registers for write and readout is presented in the table 7. Operation "R-" – means the possibility of readout, and the operation "RW" means the possibility for readout and write.

Map of the registers from address 4000

Table 7

<i>register address</i>	<i>marking</i>	<i>operation</i>	<i>parameter range</i>	<i>description</i>
4000		-W	1	Command register 1 – revert to defaults settings (except for interface settings and defined programs)
4001		R-	100...999	Program version number [x100]
4002		R-	1301...9999	Older 4 digits of the serial number
4003		R-	1...9999	Younger 4 digits of the serial number
4004		R-	0...0xFFFF	Controller status – description in the table 8
4005		R-	0...0xFFFF	Error status – description in the table 9
4006		R-	acc. to the table 10	Measured value PV
4007		R-	acc. to the table 10	Current set point SP
4008		R-	0...1000	Control signal [% x10]
4009	UNIT	RW	0...1	Unit 0 – degrees Celsius 1 – degrees Fahrenheit
4010	INPT	RW	0...8	Type of main input: 0 – thermoresistor Pt100 1 – thermoresistor Pt1000 2 – J type thermocouple 3 – T type thermocouple 4 – K type thermocouple 5 – S type thermocouple 6 – R type thermocouple 7 – B type thermocouple 8 – N type thermocouple
4011	T-LI	RW	0...1	Type of line 0 – 2-wire 1 – 3-wire
4012	DP	RW	0...1	Position of the decimal point of the main input 0 – without a decimal place 1 – 1 decimal place
4013	SHIF	RW	-1000...1000 [x10 °C] -1800...1800 [x10 °F]	Shift of the measured value of the main input
4014	OUT	RW	0...7	Output function 0 – no function 1 – control signal 2 – upper absolute alarm 3 – lower absolute alarm 4 – upper relative alarm 5 – lower relative alarm 6 – internal relative alarm 7 – external relative alarm
4015	ALG	RW	0...1	Control algorithm 0 – ON-OFF 1 – PID
4016	TYPE	RW	0...1	Type of control 0 – direct control – cooling 1 – reverse control – heating
4017	HY	RW	2...1000 [x10 °C] 2...1800 [x10 °F]	Hysteresis HY
4018	STLO	RW	acc. to the table 10	Lower threshold for self-tuning
4019	STHI	RW	acc. to the table 10	Upper threshold for self-tuning
4020	PB	RW	1...5500 [x10 °C] 1...9900 [x10 °F]	Proportional band PB
4021	TI	RW	0...9999	Integral time constant TI [s]
4022	TD	RW	0...25000	Derivative time constant TD [s x10]
4023	Y0	RW	0...1000	Correction of control signal Y0 (for P or PD control) [% x10]
4024	TO	RW	5...999	Pulse period of output [s x10]
4025	ALSP	RW	acc. to the table 10	Set point for the absolute alarm [x10]

register address	marking	operation	parameter range	description
4026	ALDV	RW	-1800...1800 [x10 °C] -3600...3600 [x10 °F]	Deviation from the set point of the relative alarm
4027	ALHY	RW	2...1000 [x10 °C] 2...1800 [x10 °F]	Hysteresis for the alarm
4028	SPL	RW	acc. to the table 10	Lower limitation of the fast set point change
4029	SPH	RW	acc. to the table 10	Upper limitation of the fast set point change
4030	SECU	RW	0...9999	Access code to the menu
4031	STFN	RW	0...1	Self-tuning function 0 – locked 1 – unlocked

Register 4002 – controller status

Table 8

bit	description
0-11	Reserved
12	Automatic/Manual mode: 0 – automatic, 1 – manual
13	State of alarm: 0 – active, 1 – inactive
14	Measured value beyond the range limits
15	Controller error – check the error register

Register 4003 – error register

Table 9

bit	description
0-14	Reserved
15	Input discalibrated

Input range limits





Table 10

sensor type	range	
	UNIT = °C [x10]	UNIT = °F [x10]
Pt100	-2000...8500	-3280...15620
Pt1000	-2000...8500	-3280...15620
Fe-CuNi (J)	-500...12000	-580...21920
Cu-CuNi (T)	-500...4000	-580...7520
NiCr-NiAl (K)	-500...13720	-580...25016
PtRh10-Pt (S)	0...17670	320...32126
PtRh13-Pt (R)	0...17670	320...32126
PtRh30-PtRh6 (B)	0...17670	320...32126
NiCrSi-NiSi (N)	-500...13000	-580...23720

12. Error signaling

Character messages signaling the incorrect controller operation.

Table 11

Error code	Reason	Procedure
	Down overflow of the range limit or lack of RTD	Check, if input signal values are situated in the appropriate range – if yes, check if there is no short circuit in the thermoresistor or the thermocouple is connected inversely.
	Upper overflow of the range limit or break in the sensor circuit	Check, if input signal values are situated in the appropriate range – if yes, check if there is no break in the sensor circuit.
	Input discalibrated	Connect the controller supply again and if that is not effective, contact the nearest service shop.
	Configuration parameters checksum error	Connect the controller supply again and if that is not effective, contact the nearest service shop.

13. Technical data

Input signals acc. to the table 12

Input signals and range limits for inputs

Table 12

Sensor type	Standard	Designation	Range	
Pt100	EN 60751+A2:1997	Pt100	-200...850 °C	-328 ...1,562 °F
Pt1000	EN 60751+A2:1997	Pt1000	-200...850 °C	-328 ...1,562 °F
Fe-CuNi	EN 60584-1:1997	J	-50...1200 °C	-58 ...2,192 °F
Cu-CuNi	EN 60584-1:1997	T	-50...400 °C	-58 ...752 °F
NiCr-NiAl	EN 60584-1:1997	K	-50...1372 °C	-58 ...2,501.6 °F
PtRh10-Pt	EN 60584-1:1997	S	0...1767 °C	32 ...3,212.6 °F
PtRh13-Pt	EN 60584-1:1997	R	0...1767 °C	32 ...3,212.6 °F
PtRh30-PtRh6	EN 60584-1:1997	B	0...1767 °C ¹⁾	32...3212,6 °F ¹⁾
NiCrSi-NiSi	EN 60584-1:1997	N	-50...1300 °C	-58 ...2,372 °F

¹⁾ Intrinsic error is related to the range limits 200...1,767 °C (392...3,212.6 °F)

²⁾ Sensor line resistance <10 Ω/wire; the connection must use wires of identical diameter and length

Basic error of real value measurement

0.3% for thermoresistance inputs

0.3% for thermoelectric inputs (0.5% – for B, R, S);

Measurement time

0.33 s

Detection of error in the measurement circuit:

- thermocouple, Pt100 range limit exceeded

Types of outputs:

- relay voltageless switching contact, rated load: 5 A/230 V

Way of output operation:

- reverse for heating
- direct for cooling

Rated operating conditions:

- supply voltage 230 VAC ±10%
- supply voltage frequency 50/60 Hz
- ambient temperature 0...23...50 °C
- storage temperature -20...+70 °C
- relative air humidity < 85% (no condensation)
- preheating time 30 min
- operating position any

Power input

< 4 VA

Weight

< 0.25 kg

Protection grade ensured by the housing

acc. to EN 60529
- from the frontal plate IP65
- from the terminal side IP20

Additional errors in rated operating conditions caused by:

- compensation of reference junction temperature changes ≤ 2°C
- resistance change of thermoresistance sensor line ≤ 50% intrinsic error value
- ambient temperature change ≤ 100% intrinsic error value /10 K

Safety requirements acc. to EN 61010-1 ¹⁾

- circuit-to-circuit insulation basic
- installation category III
- pollution grade 2
- maximum phase-to-earth operating voltage:
- for supply circuit, output 300 V

- for input circuits
- altitude a.s.l.

50 V
below 2000 m

Electromagnetic compatibility:

- noise immunity, acc. to standard EN 61000-6-2
- noise emission, acc. to standard EN 61000-6-4

14. Controller ordering code

The way of coding is given in the table 13.

Versions and ordering

Table 13

RE70 controller –		X	X
Language version	Polish	P	
	English	E	
	other ¹⁾	X	
acceptance tests	without extra quality requirements		0
	with quality inspection certificate		1
	according to buyer's specification ²⁾		X

¹⁾ after agreeing with the manufacturer

²⁾ after agreeing with the manufacturer