

User Manual
RISHABH 612...616
Analog-Digital Multimeter

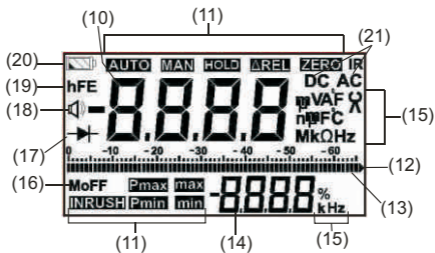

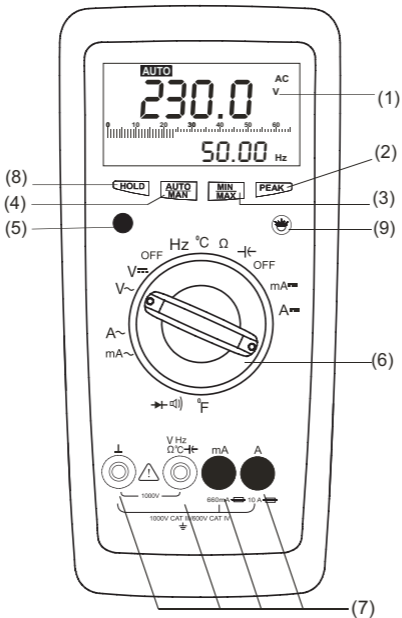

- (1) Liquid crystal display
- (2) PMAX / PMIN push button
- (3) Push button for MIN/MAX functions
- (4) Pushbutton for manual range selection
- (5) Multi function push button
- (6) Function selector switch.
- (7) Terminal sockets with automatic blocking system.
- (8) Push button for HOLD function
- (9) Push button for Back light function
- (10) Main Display for digits, decimal point and polarity
- (11) Display for manual range selection, Hold, MIN/MAX, Relative, Peak functions.
- (12) Over range indication
- (13) Bar graph for analog indication
- (14) Sub Display for digits, decimal point and polarity
- (15) Display for the unit of measured quantity.
- (16) Display for indication of Auto Off Function.
- (17) Display for Diode testing
- (18) Buzzer indication
- (19) Display for hFE measurement
- (20) Low battery indication
- (21) Display for the selected function i.e. AC or DC

Contents	Page
1. Introduction.....	4
2. Safety features and safety precautions.....	4
3. Switching the multimeter "ON".....	5
4. Function and range selection.....	6
4.1 Switching the measuring ranges.....	6
4.2 Autoranging	6
5. Liquid crystal display.....	7
5.1 Digital display	7
5.2 Analog indication	8
5.3 Backlit	8
6. Hold and Delay hold Feature.....	8
6.1 Hold feature	8
6.2 Delay hold Feature.....	8
7. "MIN/MAX" feature.....	8
8. Peak measurement.....	9
9. Voltage measurement.....	9
10. Current measurement.....	10
10.1 AC current measurement with (clip-on) current transformers	11
10.1.1 Transformer output mA/A.....	11
10.1.2 Transformer output V.....	11
11. Resistance measurement.....	13
12. Continuity test and Diode test.....	13
12.1 Continuity test.....	13
12.2 Diode test.....	13
13. Capacitance measurement (Model 615 ,616).....	15
14. Frequency and Duty measurement(Model 615 ,616).....	16
14.1 Frequency measurement.....	16
14.2 Duty cycle measurement.....	16
15. Temperature measurement.....	17
16. Specifications.....	18
17. Maintenance.....	25
17.1 Battery.....	25
17.2 Fuses.....	26
17.3 Case.....	26
18. Servicing.....	26

1. Introduction

Thank you very much for selecting our multimeter. These multimeters are manufactured as per IS 13875 and DIN 43751.

2. Safety features and safety precautions

you have chosen a multimeter which provides you a very high degree of safety. The analog - digital Multimeters are manufactured and tested in compliance with the safety standard IEC 61010-1:2001/ DIN EN 61010 - 1:2001. In case of incorrect use or careless handling, the safety of both user and multimeter is not assured.

For proper use and safe handling, is absolutely necessary to read and understand the operating instructions before using the meter.



For your safety and protection multimeters are fitted with an Automatic terminal Blocking System (ABS). It is coupled with the function selector switch which blocks the terminal sockets not necessary for measurement.

Please note the following safety precautions

- The multimeter must be operated only by persons who understand the danger of shock hazards and are aware of the necessary safety precautions. Shock hazards exist wherever voltage is more than 30V (TRMS) are present.
- Do not work alone in shock hazardous environment while carrying out measurement.
- The maximum permissible voltage between terminal Socket (7) and ground is 1000 V.
- Take into account that unexpected voltages can occur on device under test (e.g. defective instrument). For example, capacitors may be charged to a dangerously high voltage.
- Verify that test leads are in good condition .g. no cracked insulation, no open circuits in the leads or connectors.
- This multimeter must not be used for measurements on circuits with corona discharge (high voltage).
- Be particularly careful when measuring on HF circuits. Dangerous composite voltages may exist there.
- Measurements under moist environmental conditions are not permitted.
- Do not overload the measuring ranges beyond their allowable capacities. Limit values are given in specifications Refer "17. Maintenance".
- All current measuring ranges, with the exception of the 16A range of Multimeter, are protected with fuse. The maximum permissible voltage of the measuring circuit (nominal voltage of the fuse) is 1000V AC/DC in "mA" and "A" ranges.

- Multimeter has been designed for measurements in secondary current transformer circuits and has no integrated FUSE in the 16A current circuits for reducing hazards in the event of short circuits on the primary side. In circuits with voltages involving contact hazards Model 613 may only be used if the current circuit is protected by a Fuse or a circuit breaker of 20A.
- Protection provided by the digital multimeter may be impaired if the meter is not used in a manner specified in this user manual.

Meaning of the symbols on the device

	Warning of a danger point (Attention, refer to the user manual)
	Earth (ground) terminal.
	Double or reinforced insulation
CAT II / III / IV	Instrument for over voltage category II / III or IV
CE	EU conformity mark.

Repair, replacement of parts:

When opening the meter, live parts may be exposed. Therefore, the meter must be disconnected from the measuring circuit prior to opening its case for repair or replacement of parts. If repair cannot be avoided unless the meter is opened and live, this work must only be by a qualified person who understands the danger involved. performed

Faults and abnormal stress:

When it is realised that the safe operation is no longer possible, take the meter out of service and secure it against accidental use. Safe operation may not be possible,

- When the meter shows obvious signs of damage,
- When the meter no longer functions correctly,
- After prolonged storage under adverse conditions,
- Due to severe stress during transportation.
- Not using in the manner described in this manual.

3. Switching the multimeter "ON"

Battery

Your meter works on 2AA size batteries alkaline manganese cells per IEC LR6. It is provided with meter. Before you use the meter for the first time or after storage, refer to Section "17.1 Maintenance Battery" Rotate the rotary knob (6). To other than "OFF" position to switch the multimeter ON. Switch-"ON" is acknowledged by a sound signal. All segments of the LCD will as shown on page 2.

Note:

Electric discharges and high-frequency influence may cause incorrect information to be displayed and block the measuring process. Reset the meter by switching it OFF and ON again otherwise, check the battery connections. Disconnect the meter from the measuring circuit before you open it, and see section "17.Maintenance"!

Automatic Meter-OFF (MoFF)

DMM has a default auto meter off function. If the meter is idle for more than 15 minutes, the meter automatically turns the power off. When **MoFF** happens, the state of the meter is saved. The "MoFF"(16) sign on the LCD panel indicates whether the **MoFF** is enabled or not. In some cases, user might want to disable this feature, Power ON the meter by pressing any of the push functions, except HOLD(8) & multifunction(5) push buttons. After auto meter-off, pushing any of the push function or changing the rotary switch mode can turn on the meter again. If the meter is re-powered on by changing the rotary mode, the saved state is cleared. If the meter is re-powered on by push functions, the chip restores the saved state and enters HOLD mode. The LCD displays the saved value.

Turning the multimeter OFF

To turn OFF the meter rotate the rotary knob(6) to the "OFF" position

4. Function and range selection

The function selector switch (6) is coupled with the Automatic terminal Blocking System (ABS) which allows access only to two correct sockets for each function. Prior to switching to the "mA" or "A" functions or from the "mA" or "A" functions, remove the test lead from the corresponding socket. When the test leads are plugged-in, the terminal blocking systems prevents accidental switching to non permissible functions.

4.1 Switching the measuring ranges

The 660 mVAC and 660 mVDC measuring ranges are not automatically selected when the meter is switched ON. The above ranges can only be selected manually with "AUTO/MAN" key.

4.2 Auto / Manual ranging

The multimeter features auto ranging for all measuring ranges with the exception of the Ω , $\mu\Omega$, continuity, Diode, %, AAC, ADC.

Autoranging is automatically selected after switching the multimeter ON. According to the measured quantity applied, the multimeter automatically selects the measuring range which gives the best resolution. You can switch OFF auto-ranging and select the ranges manually according to the table shown in this section. Manual mode is

switched OFF when push button AUTO/MAN is pressed (4) for approximately 1s, or when the function selector switch (6) is operated, or when the meter is turned OFF and ON again.

AUTO MAN (4)	Function	Acknowledgement
		Display
Short	Manual mode ON : Used range is fixed	MAN (11)
Short	Switching sequence at : VAC / VDC - 6.6V \rightarrow 66V \rightarrow 660V \rightarrow 1000V \rightarrow 660mV \rightarrow 6.6V... mAAC / mADC - 66mA \rightarrow 660 mA \rightarrow 66mA... Ω - 660 Ω \rightarrow 6.6K Ω \rightarrow 66K Ω \rightarrow 660K Ω \rightarrow 6.6M Ω \rightarrow 66M Ω \rightarrow 660 Ω ... F - 6.6nF \rightarrow 66nF \rightarrow 660nF \rightarrow 6.6 μ F \rightarrow 66 μ F \rightarrow 660 μ F \rightarrow 6.6mF \rightarrow 40mF \rightarrow 6.6nF... Hz - 66Hz \rightarrow 660Hz \rightarrow 6.6KHz \rightarrow 66KHz \rightarrow 660KHz \rightarrow 6.6MHz \rightarrow 10MHz \rightarrow 66Hz...	MAN (11)
Long	Return to autoranging	AUTO(11)

Note - C ,Continuity ,Diode ,AAC ,ADC ,% all functions have fixed range.

5. Liquid crystal display (LCD)

5.1 Digital display

The MAIN digital display (10) shows the measured value with correct location of decimal point and sign. The selected measuring Unit (15) and the function (21) are simultaneously displayed. When measuring DC quantities, a minus sign appears in front of the digits, when the positive pole of the measured quantity is applied to the " \perp " input terminal. When upper range limit 6600 (on the range \rightarrow :1999), is exceeded then "OL" is displayed.

The digital display is updated 2.8 times per second The Sub digital display (14) shows the measured value with correct location of decimal point and sign. Main purpose of two digital display is to display simultaneous measurement as mentioned below :-

Main Display	Sub Display
Voltage	Frequency
Voltage	Min/Max
Frequency	Duty cycle
Current	Frequency

5.2. Analog indication

The analog indication with bar graph is updated 28 times per second. Analog indication is of particular use when observing variations of measured values. The analog bar graph (13) has its own polarity indication in measuring DC quantities, when the positive pole of the measured quantity is applied to the " \perp " input terminal. Analog bar graph has 65 scale divisions so that variations of the measured values around "zero" can be observed exactly. The over range is indicated by the right triangle (12) when measured value is > 6600 counts (for \rightarrow measurement > 1999).

5.3. Back light

The instrument is provided with user selectable Backlight for taking measurements in poor lighting conditions/ dark areas.

Switching the Backlit ON

By pressing  (9) key the Backlit can be switched ON for 60 Secs.

Switching the Backlit OFF

By pressing  (9) key once again before 60 secs. the Backlit can be switched OFF.

6. HOLD and Delay Hold feature

6.1 HOLD feature

After pressing "HOLD" (8) button meter stop updating the LCD panel. After enabling HOLD function the meter switch to manual ranging mode from AUTO mode, but the measuring range remains the same.

6.2 Delay Hold feature

Meter provides a Delay HOLD feature. To activate Delay HOLD feature, press "HOLD"(8) button for 2 seconds. The meter will wait for 6 seconds, then enters HOLD mode. In the 6 second period, the HOLD symbol on LCD will blink and after 6 seconds meter will hold the measured value present on LCD. To exit from delay HOLD function either change range or press "AUTO/MAN"(4), or "HOLD"(8) button again.

7. MIN/MAX feature

With the MIN/MAX function, you can hold the minimum and maximum measured value which was applied to the input of the multimeter after activating MIN/MAX function. The most important application is the determination of the minimum and the maximum value for long-term monitoring of measured parameters.

The actual measured value can still be noted/read during this feature.

Apply the measured quantity to the meter and select the measuring range prior to activating the MIN/MAX function. With the function activated, you can select the measuring ranges only manually, if you switch to another range, the stored MIN/MAX values are cleared. After pressing MIN/MAX(3) for the first time, sub-display shows maximum value. Sub-display shows minimum value, when it is pressed again. Main-display always shows current value in MIN/MAX mode. To exit from this mode press and held MIN/MAX(3) button for longer than one second or when the function selector switch (6) is operated, or when the meter is turned OFF and ON again. Pressing HOLD(8) in MIN/MAX mode makes the meter stop updating the maximum or the minimum value.

Note

MIN/MAX function is available in all the ranges & measurement except in Hz.

8. Peak measurement

Multimeter 616 provides Peak hold function to capture the maximum or minimum peak value. To enter peak mode, press PEAK(2) push button for less than 1 second. A self-calibration process will execute automatically before normal peak-hold operation. In peak mode, main-display shows current value of signal, and sub-display shows P_{MAX} or P_{MIN} value which is selected by PEAK key. After pressing PEAK(2) push button for the first time, sub-display shows P_{MAX} value. Sub-display shows P_{MIN} value, when PEAK(2) push button is pressed again. To exit PEAK-hold function, press PEAK key more than 1 second or when the function selector switch (6) is operated, or when the meter is turned OFF and ON again.

9. Voltage measurement

According to the voltage to be measured, set the function selector switch (6) to VAC or VDC. function selector switch (6) to VAC or VDC. Connect the test leads as shown. The "⊥" socket should be connected to the lowest potential ground available. In VAC mode main display always shows voltage and sub display shows frequency.

Note

The 660 mV measuring ranges can only be selected manually with the "AUTO/MAN" (4) push button

Caution

Ensure current measuring range ("mA" or "A") is not selected for voltage measurement ! When the cut-out rating of the fuses is exceeded because of incorrect operation, a dangerous situation exists!.

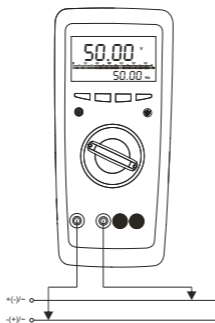

- First disconnect the power supply to the circuit being measured and/ or to the load, and discharge all capacitors within that circuit.
- With the function selector switch (6), select A for currents $>660\text{mA}$ and mA for currents $\leq 660\text{ mA}$. When measuring current of unknown magnitude, select the highest measuring range first.
- Select the function corresponding to the measured quantity by briefly pressing the yellow multi-function (5) push button.
- Each time the push button is pressed, alternate switching takes place between DC and AC. The change-over is acknowledged by a sound signal.
- The symbols DC and AC (21) are displayed as per selected function on the LCD.
- When selecting a range with the function selector switch (6), the DC function is always set by default.
- Connect the multimeter in series with the load, as shown. Ensure that the connections are tight (with least resistance).

Notes on Current measurement

- The multimeter must be used only in the power systems, where the current circuit is protected by a fuse or a circuit breaker of 20 A, and when the nominal voltage of the system does not exceed 1000V AC/DC.
- Make the measuring circuit connections mechanically strong and secure so that they do not accidentally open. The conductor cross

sections and connection points should be designed to avoid excessive heating.

- The current measuring ranges up to 660 mA are protected to a short circuit current of 25 A by a fuse 1.6 A/1000V AC/DC in conjunction, with power diodes. The cut-out capacity of the fuse is 10kA at a rated voltage of 1000V AC/DC and ohmic load.
- The 10 A current measuring ranges are protected by a 16A/ 1000V AC/DC fuse. The cut-out capacity of the fuse is 30 kA at a normal voltage of 1000V AC/DC and ohmic load.
- Replacement of the fuses is described in section " 17. Maintenance".

Caution

The measuring ranges 16 A of Multimeter 613 are not protected by a fuse!

10.1 AC current measurement with (clip-on) current transformer

10.1.1 Transformer output mA/A

Caution

If current transformers are operated with an open circuit on the secondary side, e.g. due to defective or disconnected leads, a blown fuse in the meter, or a wrong connection, dangerously high voltages can occur at the connectors. Therefore, verify that the current circuit of the multimeter and secondary winding of transformer connected to the multimeter form an intact circuit. Connect the transformer to the sockets \perp and mA and/or A. The maximum permissible operating voltage is the nominal voltage of the current transformer. When reading the measured value, take into account the transformer ratio and the additional error in indication.

Transformer output Multimeter 612

The multimeter 612 shows the switching position \propto and the corresponding sockets. Connect to this socket a (clip-on) current transformer with a transmission ratio of 1000:1 then the measured values are displayed directly in the "A" range.

10.1.2 Transformer output V

Many transformers have voltage output (referred as mV/A). The secondary output must therefore be connected to the connection sockets \perp and V.

Current measurement

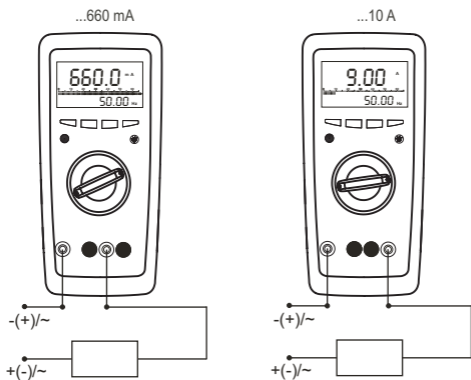

AC current measurement with (clip-on) current transformers

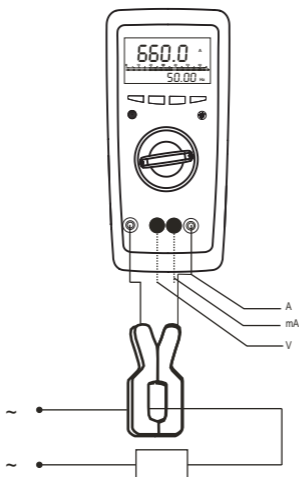

11. Resistance measurement

- Verify that the device under test is electrically dead. External voltages would falsify the measured result!
- Set the function selector switch (6) to " Ω ".
- Connect the device under test as shown.

Zero adjustment on the 660 Ω measuring range

When measuring small resistance values on the 660 Ω range, you can eliminate the resistance of the leads and contact resistance by REL function.

- Connect the test leads to the multimeter and join the free ends.
- Simultaneously press the AUTO/MAN (4) & PEAK (2) push button . The meter enter into the "REL" mode , "REL" symbol will displayed on to the LCD.
- Also "00.00" (+1digit) will displayed on main display & the resistance measured at the instance the push buttons were pressed is displayed on sub display & used as reference value.
- It is automatically deducted from the values measured there after.

The REL function can be cleared

- By pressing the AUTO/MAN (5) & PEAK (2) push buttons and it is acknowledges by sound signals.
- By switching the multimeter off.

12. Continuity test and Diode test

- Verify that the device under test is electrically dead. External voltages would falsify the measured results!

12.1 Continuity test

- Set the function selector switch (6) to "W" then press the yellow multi-function push button (5).The multimeter acknowledges turn-ON with a sound signal.
- At the same time, $\rightarrow|$ (18) appears on the LCD & "OL" will displayed on main display.
- The sound signal is generated whenever the reading is less than 30 Ω .

12.2 Diode test

- Set the function selector switch (6) to " Ω " then press the yellow multi-function push button (5) twice. The multimeter acknowledges turn-ON with a sound signal.
- At the same time, $\rightarrow|$ (18) appears on the LCD & "OL" will displayed on main display.
- The multimeter displays the forward voltage in Volts.

- As long as the voltage drop does not exceed the maximum display value of 1.999V, you can also test several series-connected elements or reference diodes with small reference voltage.
- Reverse direction or open circuit: The multimeter indicates overrange "OL".
- With the diode function selected, the meter emits a continuous sound signal whenever the reading is less than 30mV.

Note

Resistors and semiconductor junction in parallel with the diode falsify the measured results!

Changing over between Resistance ,continuity ,Diode Testing

Repeated brief pressing of the yellow multi-function switch (5) changes the measuring functions in the following order:

Resistance → Continuity → Diode → Resistance...

Resistance measurement

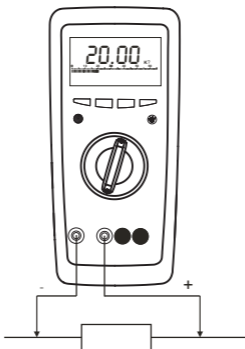

Continuity Test

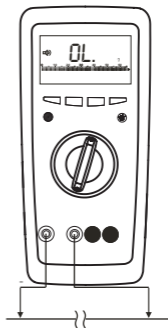
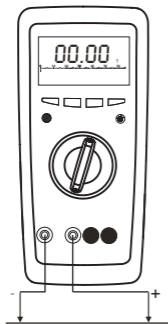

Diode Test

Forward direction

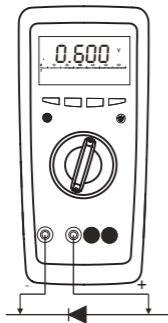

Reverse direction

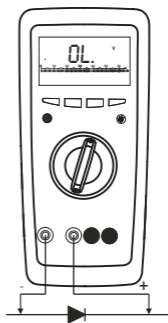

13. Capacitance measurement (Multimeter 615,616)

- Verify that the device under test is electrically dead. External voltages would falsify the measured results!
- Set the function selector switch (6) to " M "
- Connect the (discharged !) device under test to the " \perp " and " M " sockets via test lead.

Notes

- Connect polarized capacitors with the “—” pole to the “⊥” socket.
- Resistors and semiconductor junctions in parallel with the capacitor falsify the measured results!

Zero adjustment on the 6.600 nF measuring range

When measuring small capacitance values on the 6.600 nF range, the internal resistance of the multimeter and the capacitance of the leads can be eliminated by “REL” function.

- Connect the test leads to the meter without device under test.
- Press and hold PEAK(2) and press the AUTO/MAN(4) pushbutton. The meter enter into the “REL” mode, “REL” symbol will displayed on to the LCD. Also “00.00”(+1 digit) will displayed on main display & the capacitance measured at the instant the push button is pressed is displayed on sub display & used as reference value. It is automatically deducted from the values measured there after.

The REL function can be cleared

- By pressing and holding PEAK push button and then pressing AUTO/MAN key. This is acknowledged by sound signals.
- By switching the multimeter off.

14. Frequency and Duty measurement (Multimeter 615, 616)

14.1 Frequency measurement

- Set the function selector switch (6) to the “Hz”
- The multimeter switches to frequency measurement. The frequency is displayed on the main Display and duty cycle is displayed on to the Sub display.
See section “16. Specifications” for the lowest measurable frequencies and the maximum permissible voltages.
- Connections are made the same way as for **voltage measurement**.

14.2 Duty cycle measurement

With duty cycle measurement, it can determine the ratio of pulse duration to cycle time of recurring square-wave signals.

- Set the function selector switch (6) to the “Hz”.
- The multimeter switches to frequency measurement. The frequency is displayed on the main Display and duty cycle is displayed on to the Sub display.
- The duty cycle—that is the percentage pulse duration of a signal—is displayed on the LCD in %
- That is: Duty cycle (%) = $\frac{\text{Pulse duration}}{\text{Cycle duration}} \times 100$

Notes

- The applied frequency must remain constant during the duty cycle measurement.

15. Temperature measurement

The Multimeter 612...616 allows you to measure temperature with K type thermocouple in the range from 0 °C...130 °C.

- Set the function selector switch (6) to " °C "
- Connect the multimeter probe to the two unblocked terminals and thermocouple output.
- The multimeter measures temperature in °C.
- To measure temperature in °F press the yellow multi-function pushbutton (5) .

Changing over between °C and °F

Repeated brief pressing of the yellow multi-function switch (5) changes the measuring functions in the following order: °C → °F → °C....

Analog scale is disabled during Temperature measurement mode.

16. Specification

Meas. Function	Measuring Range	612	613	615	616 (TRMS)	Resolution
V(DC)	660.0mV	●	●	●	●	100 μV
	6.600V	●	●	●	●	1mV
	66.00V	●	●	●	●	10mV
	660.0V	●	●	●	●	100mV
	1000V	●	●	●	●	1V
V(AC)	660.0mV	●	●	●	●	100 μV
	6.600V	●	●	●	●	1mV
	66.00V	●	●	●	●	10mV
	660.0V	●	●	●	●	100mV
	1000V	●	●	●	●	1V
A(DC)	66.00mA	●	●	●	●	10 μA
	660.0mA	●	●	●	●	100μA
	10.00A		16A	●	●	10mA
A(AC)	66.0mA		●	●	●	10 μA
	660.0mA	●	●	●	●	100μA
	10.00A		16A	●	●	10mA
∠(AC)	66.00A	●				10mA
	660.0A	●				100mA
Ω	660.0Ω	●	●	●	●	100mΩ
	6.600KΩ	●	●	●	●	1Ω

	Input Impedance	Digital display Inherent deviation at reference condition $\pm(\dots\%rdg + \dots digits)$	Overload capacity ¹⁾	
			Overload Values	Overload Duration
	>10 G Ω // <40pF	0.7 + 5	1000 V DC AC eff / rms Sine wave	Cont.
	11 M Ω // <40pF	0.4 + 5		
	10 M Ω // <40pF	0.4 + 5		
	10 M Ω // <40pF	0.4 + 5		
	10 M Ω // <40pF	0.4 + 5		
	>10 G Ω // <40pF	1.2 + 5		
	11 M Ω // <40pF	1.0 + 3		
	10 M Ω // <40pF			
	10 M Ω // <40pF			
	10 M Ω // <40pF			
	Voltage Drop			
	66.00mV	0.8 + 5	0.7A	Cont.
	66.00mV	0.8 + 5		
	10.00mV	1.5 + 5	12A ⁶⁾	7)
	66.00mV	0.8 + 5	0.7A	Cont.
	66.00mV	0.8 + 5		
	10.00mV	1.5 + 5	12A ⁶⁾	7)
	66.00mV	0.8 + 5	0.7A	Cont.
	66.00mV	0.8 + 5		
	No load Voltage			
	-3.3V	0.8 + 5		
	-1.08V	0.8 + 5		

16. Specification

Meas. Function	Measuring Range	612	613	615	616 (TRMS)	Resolution
Ω	66.00K Ω	●	●	●	●	10 Ω
	660.0K Ω	●	●	●	●	100 Ω
	6.600M Ω	●	●	●	●	1K Ω
	66.00M Ω	●	●	●	●	10K Ω
BUZZER	660.0 Ω	●	●	●	●	100m Ω
DIODE	2.000V	●	●	●	●	1mV
F	6.600nF			●	●	1pF
	66.00nF			●	●	10pF
	660.0nF			●	●	100pF
	6.600 μ F			●	●	1nF
	66.00 μ F			●	●	10nF
	660.0 μ F			●	●	100nF
	6.600 mF			●	●	1 μ F
	40.00mF			●	●	10 μ F
Hz	66.00Hz			●	●	0.01Hz
	660.0Hz			●	●	0.1Hz
	6.600KHz			●	●	1Hz
	66.00KHz			●	●	10Hz
	660.0KHz			●	●	100Hz
	6.600MHz			●	●	1KHz
	10.00MHz			●	●	10KHz
%	1.0...98.90%			●	●	0.01%
$^{\circ}$C/$^{\circ}$F	0...1300 $^{\circ}$ C	●	●	●	●	1 $^{\circ}$ C

1) At 0 $^{\circ}$ C ... + 40 $^{\circ}$ C

2) At input >1Vrms

3) For <10 KHz

	Input Impedance	Digital display Inherent deviation at reference condition $\pm(\dots\%rdg + \dots digits)$	Overload capacity ¹⁾	
			Overload Values	Overload Duration
	-1.08V	0.8 + 5	1000 V DC AC eff / rms Sine wave	Max 10 S
	-1.08V	0.8 + 5		
	-1.08V	1.0 + 5		
	-1.08V	2.0 + 5		
	-3.3V	0.8 + 5		
	3.3V	2.0 + 10		
	—	3.0+40		
		2.0+10		
		2.0+10		
		2.0+10		
		2.0+10		
		5.0+10		
		5.0+10		
	10Hz (F min)	0.2 + 2 ²⁾		
	—			
	0.9% (Fmin)	10Hz... 1kHz \pm 5Digit 1kHz...10kHz; \pm 5 Digit/kHz ³⁾		
	—	2.0+3 ⁴⁾		

4) Without sensor

5) Display with (clip-on) current transformers 1000 : 1

6) For Model 613 (without FUSE) 16A 10 min.

7) For Model 613 (without FUSE) 12A 5 min. /16A 30 s

Influence Quantities and Variations

Influence quantity	Range of Influence	Measured Quantity/ Measuring Range	Variation ¹⁾ ± (...% of rdg. + ... digits)
Temperature	0 °C +21 °C and +25 °C...+40°C	VDC	1 X Intrinsic error
		VAC	
		ADC	
		AAC	
		Ω	
		Diode	
		F	
		Hz	
		%	
Frequency of the measured quantity	20 Hz...< 50 Hz	660mV~	1.0+3
	> 50Hz... 200 Hz		5.0+3
	20 Hz...< 50 Hz	66.....1000V~	1.0+3
	> 50Hz... 2 KHz		5.0+7
	20Hz ...< 50 Hz	A~	1.0+3
	>50 Hz... 2 kHz		5.0+3
Crest Factor CF	1....1.4	V~ ³⁾ ,A~ ³⁾	± 1 % of rdg
	1.4....5		± 5 % of rdg
Battery Volatage	 ⁴⁾ ...< 2.49 V > 2.49 V ...3 V	VDC	5 Digit
		V~,ADC	10 Digit
		AAC	6 Digit
		660Ω	4 Digit
		6.600kΩ-66.00MΩ	3 Digit
		NF,F,mF	5 Digit
		Hz	5 Digit
		%	5 Digit
Relative Humidity	75% 3 Days Meter off	V~,VDC	1 X Intrinsic error
		A~,ADC	
		Ω	
		F	
		Hz	
		°C	
		%	

- 1) With temperature: Error data apply per 10 K change in temperature.
With frequency: Error data apply to a display from 300 digits onwards.
- 2) With unknown waveform (crest factor $CF > 2$), measure with manual range selection
- 3) With the exception of sinusoidal waveform.
- 4) After the "  " symbol is displayed.

Influence quantity	Range of Influence	Measuring ranges	Attenuation
Common mode interference voltage	Noise quantity max. 1000 V $\overline{\overline{\sim}}$	V $\overline{\overline{\sim}}$	> 120 dB
	Noise quantity max. 1000 V \sim 50 Hz, 60 Hz sinusoidal	6.6V \sim , 66V \sim 660V \sim	>100 dB
		660mV \sim 1000 V \sim	> 80 dB
Normal mode interference voltage	Noise quantity V \sim value of the measuring range at a time max. 1000 V \sim , 50 Hz, 60 Hz. sinusoidal	V $\overline{\overline{\sim}}$	> 50 dB
	Noise quantity max. 1000 V -	V \sim	> 110 dB

Display

Liquid crystal display(63 mm x 43 mm) with analog indication and digital display and with display of the unit of measured quantity, function and various special functions.

Analog

Indication : LCD scale with bar graph
 Scale length : 55 mm
 Scaling : 65 scale divisions during all the measurement
 Polarity indication : With automatic reversal
 Overrange indication : By triangle
 Sampling rate : 28 times/s

Digital

Height of Main Display numerals: 7 segment numerals : 12mm
 Height of Sub Display numerals : 7 segment numerals : 7mm
 Number of counts : 4 digit : 6600 counts
 Overrange display : "OL" is shown
 Polarity display : "-" sign is shown,
 When positive pole connected to " \perp "
 Sampling rate : 2.8 times/sec

Power supply

- Battery : 2 AA size batteries alkaline manganese cells as per IEC LR6.
- Service life : for 612, 613, 615: 600 hrs. for VDC, ADC
300 hrs. for VAC, AAC
for 616: 400 hrs. for VDC, ADC
200 hrs. for VAC, AAC
- Battery test : Automatic display of "  " symbol when battery voltage falls below following value: approx. 2.

Electromagnetic compatibility (EMC)

- Emission : EN 61326 : 2002 Class B
- Immunity : IEC 61000-4-2 8 kV atmosphere discha
4 kV contact discharge
IEC 61000-4-3 : 3 V/m

- Safety : IEC 61010-1-2010
- Installation category : CAT IV 600V CAT III 1000V
- IP for water & dust : IEC 60529
- Pollution degree : 2
- High Voltage Test : 6.7 kV (IEC 61010-1-2010)
- Altitude : 6.7 kV (IEC 61010-1-2010)

Fuses

Fuse for upto 660 mA ranges

FF (UR) 1.6 A / 1000V AC/DC; 6.3mm X 32mm; rating 10kA with 1000VAC/DC and ohmic load; in conjunction with power diodes, protects all current measuring ranges upto 660mA.

Fuse for upto 10A ranges (Not for DMM 613)

FF (UR) 16 A / 1000 V AC/DC; 10mm x 38mm; rating 30 kA with 1000VAC/DC and ohmic load; protects the 10A ranges upto 1000V AC/DC See "17. maintenance" for types of fuses.

Response time (after manual range selection)

Measured quantity/ measuring range	Response time		Transient response for step function of the measured quantity
	of analog indication	of digital display	
V $\overline{\text{---}}$, V \sim , °C	0.1 s	1 s	from 0 to 80 % of upper range limit
A $\overline{\text{---}}$, A \sim	0.1 s	1 s	from 0 to 50 % of upper range limit
6600...6.6 MO	0.1 s	1 s	
66 MO	0.2s	2 s	from 0 to 80 % of upper range limit
\rightarrow	0.1 s	1 s	
6.6nF... 66 μ F	0.7 s	max. 1 s	
660 μ F...6.6 mF	1.4 s	max. 3 s	
66 mF	7.0 s	max. 15 s	
660 Hz, 6.6KHz	2.0 s	max. 2 s	
66 KHz, 660 Khz 1MHz	0.5 s	max. 1 s	
% (\Rightarrow 10 Hz)	0.7 s	max. 2.5 s	

Reference conditions

Ambient temperature	23 °C ± 2 K
Relative humidity	45% ... 55 % RH
Frequency of measured quantity	45Hz ... 65 Hz
Waveform of the measured quantity	sinusoidal
Battery voltage	3V ± 0.1V

Environmental conditions

Functional temperature range	-10 °C...50 °C
Storage temperature range	-25 °C...+70 °C (without batteries)
Relative Humidity	45.....75 %
Altitude	up to 2000m

Mechanical configuration

Protection for the	Meter	: IP 65
	Connection sockets	: IP 20 according to DIN VDE 0470 Part 1 /EN 60529
Dimensions	86 mm x 185 mm x 55 mm	
Weight	350 g approx., including battery	

17. Maintenance

Caution

Disconnect the meter from the measuring circuit before you open it to replace the battery or the fuse!

17.1. Battery

Prior to initial start-up, or after storage of multimeter, verify that the cells of multimeter does not leak. Repeat this check in regular short intervals. If the cells leaks, completely remove the cells carefully with a moist cloth and install a new cells before you operate multimeter again.

When the symbol "  " (17) appears on the LCD (1) replace the cells as soon as possible. Measurement can be done, but a reduced measuring accuracy must be taken into account.

The multimeter operates with 2 AA size batteries alkaline manganese cells per IEC LR6

Replacing the Battery

- Place the multimeter on its face, loosen the single screw present on the rear side and remove the battery cover from bottom side.
- Remove the cells from the battery compartment and replace them with the new cells (for specifications refer "Power supply").
- Tighten the bottom cover with the two screws.
- Remove the blown fuse, e.g. with the aid of a probe, and replace it with a new one.

17.2 Fuses

The 16 A fuse protects the 10 A range, the 1.6 A protects 66mA ,660mA current measuring ranges. All other measuring ranges continue to function. When a fuse blows, first eliminate the cause of the overload before using the multimeter again !

Replacing the Fuses

- Place the multimeter on its face, loosen the two screws on the rear and remove the bottom cover by, lifting it from the bottom.
- Remove the fuses from the fuse holders.
- Tighten the bottom cover with the two screws.
- Remove the blown fuse, e.g. with the aid of a probe, and replace it with a new one.

Types fuses for current measuring ranges up to 660 mA:

For current measuring ranges up to 660 mA:

--FF (UR) 1.6 A / 1000 V AC/DC ; (10 KA) ; 6.3 mm x 32 mm

For 10A current measuring range:

--FF (UR) 16 A / 1000 V AC/DC ; (30 KA) ; 10 mm x 38 mm

Caution

Absolutely verify that only the specified fuse is installed! If a fuse of other cut-out capacity, other nominal current or other switching capacity is used, a dangerous situation exists, and there is danger of damaging protective diodes, resistors or other components. The shorting of the fuse holder is not permissible.

17.3 Case

Special maintenance of the case is not required .Take care that the surface between the connection sockets is clean. For cleaning take a moist cloth. Avoid scrubbing.

19. Servicing

When you need service, please contact :

Rishabh Instruments Pvt. Ltd.

F-31, M.I.D.C., Satpur,

Nashik - 422 007

Maharashtra, India

Telephone : (0253) 2202202, 2202162

Fax : (0253) 2351064, 2202162

E-mail : service@rishabh.co.in

www.rishabh.co.in

Note

Note



RISHABH INSTRUMENTS PVT. LTD.

Factory: F-31, MIDC, Satpur, Nashik-422 007 India

Phone(0253) 2202202, 2202162

Fax : 91 - 0253 - 2351064, 2202302

E-mail : info@rishabh-instruments.com

www.rishabh.co.in

Printed in India, Subject to change without Notice