

# OPERATING MANUAL

## Transducer for AC Current RishCON-I11



# Operating Instructions

## Contents

1. Read first and then	3
2. Brief Description	3
3. Product Features	3
4. Overview of the Parts	4
5. Scope of supply	5
6. Technical Data	5
7. Mounting	9
8. Electrical Connections	11
9. Commissioning	13
10. Dimensional Drawings	13
11. Ordering Information	14

## 1. Read first and then



The proper and safe operation of the device assumes that the Operating Instructions are read and the safety warnings given in the various sections Mounting, Electrical connections, Commissioning are observed.



All operations concerning installation, electrical connections and commissioning, must be carried out by qualified, skilled personnel, and national regulations for the prevention of accidents must be observed.

## 2. Brief Description

The Transducer converts a sinusoidal AC Current or Voltage into Two load independent DC Current or a load independent DC Voltage proportional to the measured value.

The transducer outputs are galvanically isolated from the input signal and auxiliary supply.

## 3. Product features

Arithmetical mean value measurement

Calibration to RMS with sine waveform (Average Value)

Accuracy class 0.5

as per International Standard IEC/EN 60 688.

Isolated DC current or DC voltage outputs.

Output Response Time < 200 ms.

Fast and easy installation on DIN RAIL or onto a wall or in panel using optional screw hole bracket.

Connection Terminal: Conventional Screw type.

## 4. Overview of the parts

Figure 1 shows those parts of the device which are used for mounting, electrical connections and other operations described in the Operating instructions.

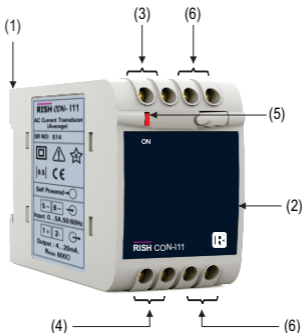
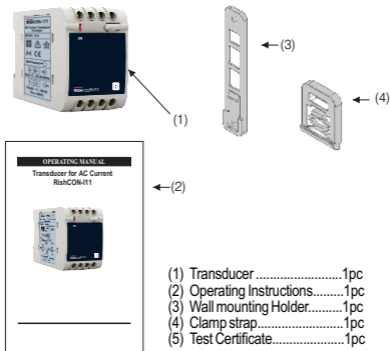

**Fig. 1:** Overview of the Transducer parts

- (1) Fixing Bracket
- (2) Front sticker
- (3) Input Terminals
- (4) Output Terminals
- (5) Red LED for Power ON indication.
- (6) Not Connected Terminals (NC).

## 5. Scope of Supply

The set of the Transducer consist of :



- (1) Transducer .....1pc
- (2) Operating Instructions.....1pc
- (3) Wall mounting Holder.....1pc
- (4) Clamp strap.....1pc
- (5) Test Certificate.....1pc

**Fig. 2: Transducer Set**

## 6. Technical Data

### Current Transducer (RishCON - I11)

Final value of Nominal Input 1A, 5A.

Current IN (X2) AC RMS

Nominal Frequency  $F_N$  50 or 60Hz.

Nominal Input Current Burden	Full O/p value [mA]	[VA]
1		<0.8VA at IN
5		<1.8VA at IN
10		<2.2VA at IN
20		<2.5VA at IN

Overload Capacity	
1.5*IN	Continuously,
2*IN	for 10 second, repeated 10 times at 10 second intervals,
10*IN	for 3 second, repeated 5 times at 5 minute intervals,
40*IN	for 1 second, 1 time.

### Measuring Output Y:

Output type	Load independant DC current IA or DC voltage output VA
Load independent DC current Output range	0...1/0...5/0...10/0...20 mA, 4...20 mA
Output burden with DC current output signal DC voltage output range	$R_{ext} \max. [k\Omega] = 15 VA/IAN [mA]$ [IAN = full output value] Output VA not superimposed : std range of VA: 0...10V
Output burden with DC current output signal	$R_{ext} \geq 200k\Omega/V$
Current limit under overload	$\leq 1.5 * IAN$ for current output Approx. 30 mA for voltage
Voltage limit under $R_{ext} = \infty$	<24 V
Residual Ripple in output signal	Current Ripple $\leq 1\% p.p.$
Response time	<200ms
Output standard ranges	Current : 0...1/0...5/0...10/0...20 mA Voltage : 0-10V
DC power supply	12-30V (only for 2-wire connection with output 4...20mA)

### Accuracy( Acc. to IEC/EN 60 688)

Accuracy	Class 0.5
----------	-----------

## Reference conditions for Accuracy

Ambient temperature	23°C, ± 5k
Pre-conditioning	≤ 5 min.
Input variable	0 to 100% for current measurement 20 to 100% for voltage
Input signal frequency	50...60Hz ± 2%
Distortion factor	< 0.5%
Output load	Current output: 0 - Rext Max. Voltage output: Rext Max to ∞
Power Supply	± 1% for 24Vdc with 4...20mA output.

## Influence Effects (maxima) :

Linearity error	< ± 0.3%
Frequency	± 0.3% (Fn ± 0.2%)
Dependances on external resistance	± 0.1% Δ Rext Max

## Additional Errors

Temperature influence	± 0.2% /10°C.
Curve shape of Input	Sine waveform only
Frequency of input variable	45...200Hz ± 0.5%
Influence of Variations	As per IEC/EN 60 688 standard.

## Output characteristics:

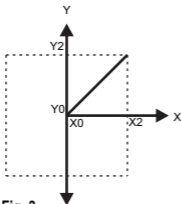

Fig. 3

X0 = Start value of input  
X2 = End value of input  
Un = Nominal input voltage

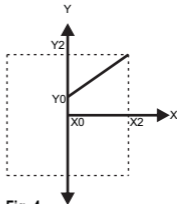
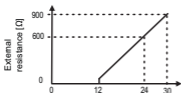

Fig. 4

Y0 = Start value of output  
Y2 = End value of output  
In = Nominal input current

2 wire output with 4...20mA,  
12...30V DC AUX:  
With 2 wire connection



$$H = \text{Power Supply [V]} \\ H[V] - 12V. \\ R_{ext \text{ max. [k}\Omega]} = \frac{H[V] - 12V.}{20\text{mA}}$$

**Fig. 5**  
Standard ranges of  $I_A = 4...20\text{mA}$ ,  
External Resistance  $R_{ext}$  -  
dependent  
on power supply  $H(12...30\text{V DC})$

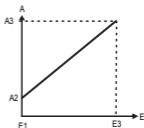

**Fig. 6**  
Characteristics A "Standard  
and live zero."

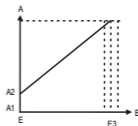

**Fig. 7**  
Characteristics A "Standard"  
Variable Sensitivity and live  
zero.

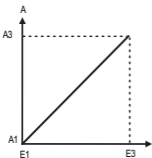

**Fig. 8**  
Characteristics A "Standard"

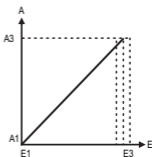

**Fig. 9**  
Characteristics A "Standard Variable  
Sensitivity".  
 $E3 \pm 5\%$  or  $\pm 10\%$



**Safety:**

Protection Class	II (Protection Isolated, EN 61 010)
Protection	IP 40, housing according to EN 60 529 IP 20 ,terminal according to EN 60 529
Pollution degree	2
Insulation Voltage	7750VDC, Input versus outer surface 7750VDC, Output versus outer surface 5500VDC, Input versus output.

**Installation Data:**

Mechanical Housing	Lexan 940 (polycarbonate) Flammability Class V-0 acc. To UL 94, self extinguishing, non dripping, free of halogen
Mounting position	Rail mounting / wall mounting
Weight	Approx. 0.5Kg

**Connection Terminal:**

Connection Element	Conventional Screw type terminal with indirect wire pressure
Permissible cross section of the connection lead	$\leq 4.0 \text{ mm}^2$ single wire or $2 \times 2.5 \text{ mm}^2$ fine wire

**Environmental:**

Nominal range of use	-25 °C... <u>23 °C</u> ... 55 °C (usage Group II)
Storage temperature	-40 °C to 70 °C
Relative humidity of annual mean	$\leq 75\%$ $\leq 90\%$ Enhanced Climatic Rating
Altitude	up to 2000 m

**Ambient tests:**

IEC 60 068-2-6	Vibration
Acceleration	$\pm 2 \text{ g}$
Frequency range	10....150...10Hz,
Rate of frequency sweep	1 octave/minute
Number of cycles	10, in each of the three axes
IEC 60 068-2-27	Shock
Acceleration	3 x 50g 3 shocks in each direction

## 7. Mounting

The Transducer can be mounted either on a top-hat rail or directly onto a wall or mounting plate.



Make sure that the ambient temperature stays within the permissible limits :  
0° C and 45° C

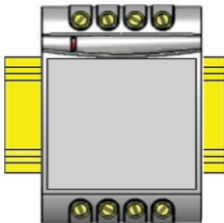

As the front of the enclosure conforms to IP 40. The terminals of the product should be protected from liquids. Transducer should be mounted in a reasonably stable ambient temperature and where the operating temperature is within the range 0 to 45°C. Vibration should be kept to a minimum and the product should not be mounted where it will be subjected to excessive direct sunlight.

### Caution

1. In the interest of safety and functionality this product must be installed by a qualified engineer, abiding by any local regulations.
2. Voltages dangerous to human life are present at some of the terminal connections of this unit. Ensure that all supplies are de-energised before attempting any connection or disconnection.
3. These products do not have internal fuses therefore external fuses must be used to ensure safety under fault conditions.

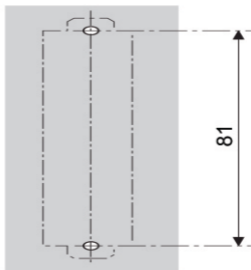

**Fig. 10.** Drilling plan

Drill 2 holes in the wall or panel as shown in the drilling plan (Fig. 3). Now secure the wall mounting holder to the wall or panel using two 4 mm diameter screws.

## 8. Electrical connections

Input connections are made directly to screw-type terminals with indirect wire pressure. Choice of cable should meet local regulations. Terminal for Current inputs will accept up to 4.0 mm<sup>2</sup> single wire or 2 x 2.5 mm<sup>2</sup> fine wire.



Make sure that the cables are not live when making the connections!

Connection	Terminal details	
Measuring input	~	5 6
Measuring output	+ -	1 2
Not Connected	NC	3,4,7,8

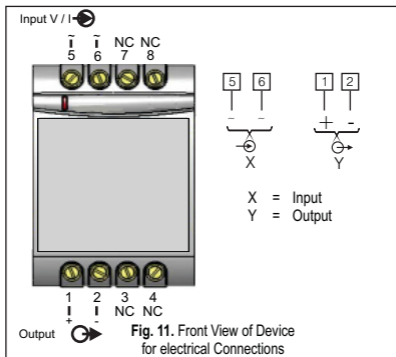

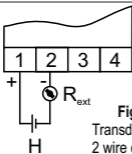

**Fig. 13.**

Transducer with live zero output 4..20mA and 2 wire connection, power supply H12...30V DC

Also note that...



...The data required to carry out the prescribed measurement must corresponds to those marked on the sticker.

(measuring input  $\ominus$ , measuring output  $\ominus$ ).

...the total loop resistance connected to the output (receiver + leads) does not exceeds the maximum permissible value  $R_{ext}$ ! see "**Measuring Output Y**" in section "6. Technical data" for maximum values of  $R_{ext}$ !

...the measurement output cable should be twisted pair and run as far as away from heavy current cables.

## 9. Commissioning

Switch on the measuring inputs. The Red LED light continuously ON after switching on.

## 10. Dimensional drawings

**Note :** All Dimensions are in mm.

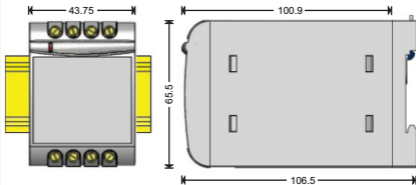

**Fig. 14.** Transducer Dimensions.

## Ordering information

Product Code	CA11	X	XX	XX	00000000
Model	AC CURRENT TRANSDUCER Class 0.5	A			
Input Current range	Fixed Input 0...1A		11		
	Fixed Input : 0...5A		51		
Output	0 ... 10mA			01	
	0 ... 5mA			02	
	0 ... 20mA			03	
	4 ... 20mA			04	
	0...10V			05	

## Notes

## Notes