

# PROGRAMMABLE DPM

## 1 PHASE PROGRAMMABLE DPM

AC Volt Meter (1Φ) : PGDV

AC Ammeter (1Φ) : PGDA

### Installation & Operating Instructions

Section	Contents
1.	Introduction
2.	Measurement Reading Screens
3.	Programming
	3.1 Password Protection
	3.2 Set Up Screens
	3.2.1 Potential Transformer Primary value
	3.2.2 Potential Transformer Secondary value
	3.2.3 Current Transformer Primary value
	3.2.4 Current Transformer Secondary value
	3.2.5 Reset of min/max values
	3.2.6 Auto Scrolling
4.	Installation
	4.1 EMC Installation Requirements
	4.2 Case Dimensions and Panel Cut-out
	4.3 Wiring
	4.4 Auxiliary Supply
	4.5 Fusing
	4.6 Earth / Ground Connections
5.	Connection Diagrams
	5.1 Connection Diagrams for PGDV 96X96 models
	5.2 Connection Diagrams for PGDA 96X96 models
	5.3 Connection Diagrams for PGDV 48X96 models
	5.4 Connection Diagrams for PGDA 48X96 models
6.	Specifications

15000670\_Rev. F 02/2013

#### Available Models :

1. PGDV: 96X96 with 14mm Display

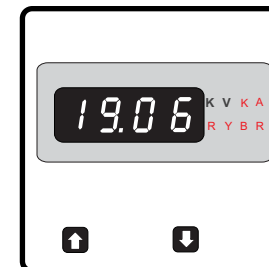

2. PGDA : 96X96 with 14mm Display

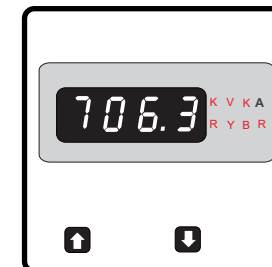

3. PGDV: 96X96 with 20mm Display



4. PGDA : 96X96 with 20mm Display

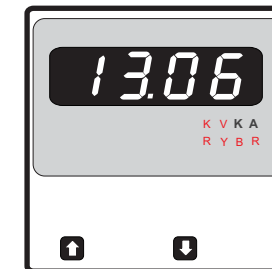

4. PGDV : 48 X 96 size



4. PGDA : 48 X 96 size



## 1. Introduction

The PGDV/A Series is a panel mounted 96 x 96mm and 48X96mm Digital Panel Meters for the measurement of AC Voltage and current in single phase systems.

The instrument integrates accurate measurement technology. The measurements are True RMS upto 15th Harmonic. The parameters are displayed with Ultra high brightness LED display with 20mm and 14mm Digit height options.

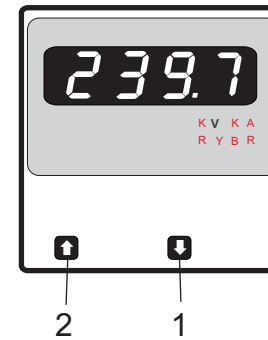

Programmable DPM can be configured and Programmed at site for the following : PT Primary, PT Secondary, CT Primary, CT secondary.

The front panel has two push buttons for user interface to scroll through the available parameters the two keys has function as follow :

- 2** : Scrolls through parameter in upward sequence.  
**Display sequence PGDV** : System voltage, max. Value, min value and then back to system Voltage.  
**Display sequence PGDA** : system Current, max value min value and back to system current.
- 1** : Scrolls the parameters in Reverse of above sequence.

These DPMs come with 14mm and 20mm Display options, which enables to take readings from long distance. The unit of display is illuminated from back side with bright LEDs, which overcomes the problem with conventional LED annunciators that could not be clearly understood the parameter being displayed from a distance.

TABLE 1: Parameters Displayed with PGDV models

Measured Parameters	Unit of measurement
System Voltage	Volts
System Voltage max. Value (Hi)	Volts
System Voltage min. Value (Lo)	Volts

TABLE 2: Parameters Displayed with PGDA models

Measured Parameters	Unit of measurement
System Current	Amp
System Current max. Value (Hi)	Amp
System Current min. Value (Lo)	Amp

## 2. Measurement Reading Screens

In normal operation the user is presented with the measurement reading screens. These screens may be scrolled through one at a time in incremental order by pressing the **2** key and in decrementing order by pressing **1** key.

### A. Display Screens of PGDV Models :

Screen 1 : System Voltage

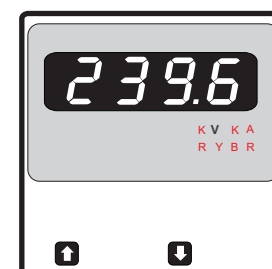

Screen 2 : System Voltage max Value  
Value displayed after "Hi" flashing on Display

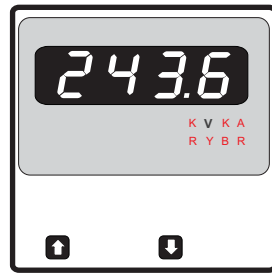

Screen 3 : System Voltage min Value  
Value displayed after "Lo" flashing on Display

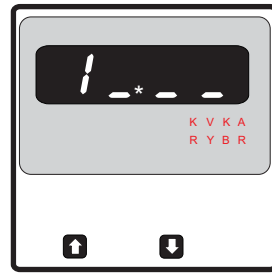
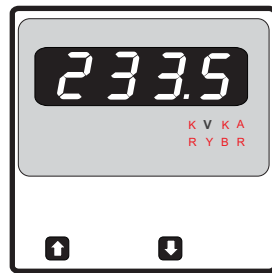

Enter Password, first digit entered, prompt for Second digit.  
(\* Denotes that decimal point will be flashing).

Use the "↑" key to scroll the value of the second digit from 0 through to 9, the value will wrap from 9 round to 0.

Press the "↓" key to advance to next digit.

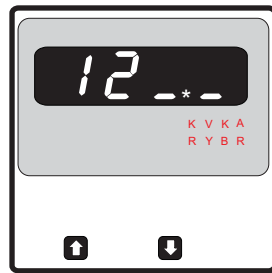

Enter Password, second digit entered, prompt for Third digit.  
(\* Denotes that decimal point will be flashing).

Use the "↑" key to scroll the value of the third digit from 0 through to 9, the value will wrap from 9 round to 0.

Press the "↓" key to advance to next digit.



Enter Password, third digit entered, prompt for Fourth digit.  
(\* Denotes that decimal point will be flashing).

Use the "↑" key to scroll the value of the fourth digit from 0 through to 9, the value will wrap from 9 round to 0.

Press the "↓" key to advance to next digit.

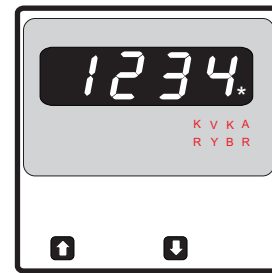

Enter Password, fourth digit entered, awaiting verification of the password.



Password confirmed.

Pressing "↑" key will advance to the "New Password / change Password" entry stage.

Pressing the "↓" key will advance to the System Type Selection screen (See section 3.2).

## B. Screens of PGDA Models :

Screen 1 : System Current

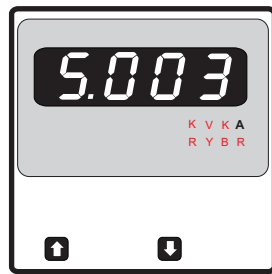

Screen 2 : System Current Max. Value  
Value displayed after "Hi" flashing on Display

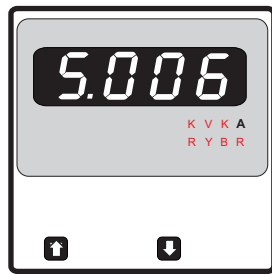

Screen 6 : System Current min. Value  
Value displayed after "Lo" flashing on Display

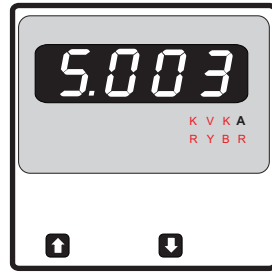

## 3. Programming

### 3. Programming

The following sections comprise step by step procedures for configuring the **PGDA and PGDV** for individual user requirements.

To access the set-up screens press and hold the "↑" and "↓" Keys Simultaneously. This will take the User into the Password Entry Screen Followed by "CodE" on Display (Section 3.1).

#### 3.1. Password Protection

Password protection can be enabled to prevent unauthorised access to set-up screens. By default password protection is not enabled. Password protection is enabled by selecting a four digit number other than 0000. Setting a password of 0000 disables the password protection.

##### Password Entry :

Enter Password, prompt for first digit.  
(\* Denotes that decimal point will be flashing).

Press the "↑" key to scroll the value of the first digit from 0 to 9, the value will wrap from 9 round to 0.

Press the "↓" key to advance to next digit.

In the case, where the Password is "0000" pressing the "↓" key when prompted for the first digit will advance to the "Password Confirmed" screen.

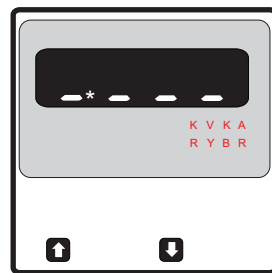

## Temperature Coefficient

Voltage (PGDV)	0.025% / °C (10...120% of Rated Value)
Current (PGDA)	0.05% / °C (5...120% of Rated Value)
Optional : Current (PGDA Max 200% input)	0.05% / °C (5...200% of Rated Value)
(For Rated value range of use 0... 50°C )	

Error change due to variation of an influence quantity      2 \* Error allowed for the reference condition applied in the test.

## Display

LED	1 line 4 digits .
Digit height	20mm / 14mm optional
Annunciator LEDs	For Displaying Units and Parameter
Update rate	Approx. 1 seconds

## Controls

User Interface	2 Keys
----------------	--------

## Isolation

Dielectric voltage withstand test between circuits and accessible surfaces	3.3 kV RMS 50 Hz for 1 minute between all electrical circuits.
--	--

## Standards

EMC Compatibility	IEC 61326-1:2005 10V/m min-Level 3 industrial low level Electromagnetic radiation environment
Safety	IEC 61010-1 , Year 2001
IP for water & dust	IEC 60529

## Environmental conditions

Operating temperature	0 to 50°C
Storage temperature	-25 to 70°C
Relative humidity	0 .. 90 % RH (Non condensing)
Warm up time	3 minute (minimum)
Shock	15g in 3 planes
Vibration	10 .. 55 Hz, 0.15mm amplitude
Enclosure front	IP 50
Enclosure back	IP 20

## Enclosure

Material	Polycarbonate Housing .	
Terminals	Screw-type terminals	
	<b>96X96 models</b>	<b>48X96 Models</b>
Bezel Size (DIN 43718)	---	48mm X 96mm
Depth	55mm	68mm
Weight	300g Approx.	250g Approx.

The Information contained in these installation instructions is for use only by installers trained to make electrical power installations and is intended to describe the correct method of installation for this product. However, Company has no control over the field conditions which influence product installation.  
It is the user's responsibility to determine the suitability of the installation method in the user's field conditions. Company only obligations are those in Company standard Conditions of Sale for this product and in no case will Company be liable for any other incidental, indirect or consequential damages arising from the use or misuse of the products.

## 5. Connection Diagrams

### 5.1 Connections For PGDV 96X96 models

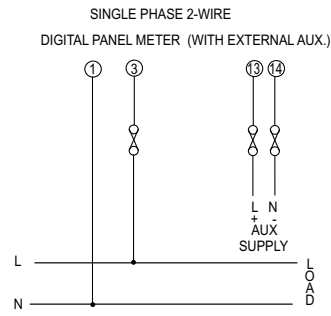

### 5.2 Connections For PGDA 96X96 models

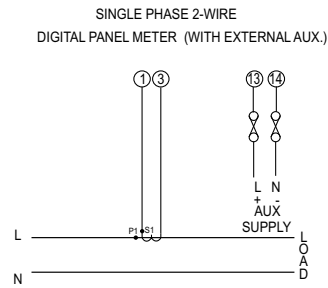

### 5.3 Connections For PGDV 48X96 model

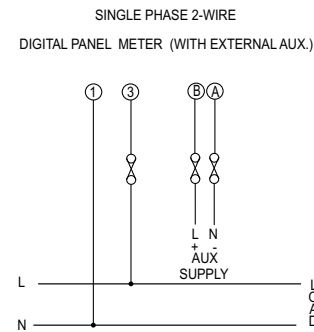

### 5.4 Connections For PGDA 48X96 model

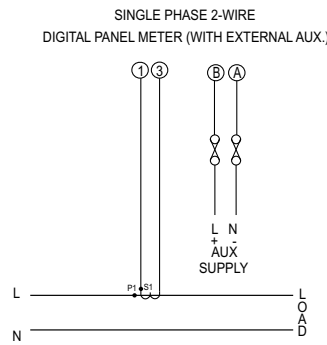

## 6. Specifications :

### Inputs (PGDV) :

Nominal Input Voltage	290V <sub>LN</sub>
System Primary Values	60V to 999 kV, programmable at site
System Secondary Values	60V to 290 V, programmable at site
Max continuous input voltage	120% of Rated Value
Overload Indication	"-oL-" (If input is greater than 125% of secondary value.)
Max short duration input voltage	2 x Rated Value (1s application repeated 10 times at 10s intervals)
Nominal input voltage burden	0.3VA approx. per phase

### Inputs (PGDA) :

Nominal Input Current	5A AC
System CT primary values	Standard Values 1 to 999 kA
System Secondary Values	1A / 5A, programmable at site
Max continuous input current	120% of Rated Value
Overload Indication	"-oL-" (If input is greater than 125% of secondary value.)
Nominal input Burden	0.2VA approx. per phase
Max short duration current input	20 x Rated Value (1s application repeated 5 times at 5 min. intervals)

### Optional: Inputs (PGDA Max 200% Input) :

Nominal Input Current	5A AC
System CT primary values	Standard Values 1 to 999 kA
System Secondary Values	1A / 5A, programmable at site
Max continuous input current	200% of Rated Value
Overload Indication	"-oL-" (If input is greater than 210% of secondary value.)
Nominal input Burden	0.2VA approx. per phase
Max short duration current input	20 x Rated Value (1s application repeated 5 times at 5 min. intervals)

### Auxiliary Supply :

External Auxiliary Supply	40V to 300V AC/DC (+/- 5%)
Frequency Range	45 to 65 Hz
VA Burden	3 VA approx.

### Operating Measuring Ranges

PGDV : Voltage	10 ... 120 % of Rated Value
PGDA : Current	5 ... 120 % of Rated Value
Optional: PGDA (Max 200% input) : Current	5 ... 200 % of Rated Value
Frequency	45 ... 65 Hz

### Accuracy

PGDV : Voltage	0.5 % of range + 1 Digit (10...100% of Nominal Value)
PGDA : Current	0.5 % of range + 1 Digit (10...100% of Nominal Value)
Optional: PGDA (Max 200% input) : Current	0.5 % of range + 1 Digit (10...100% of Nominal Value)

### Reference conditions for Accuracy :

Reference temperature	23°C ± 2°C
Input frequency	50 or 60Hz ± 2%
Input waveform	Sinusoidal (distortion factor 0.005)
Auxiliary supply voltage	Rated Value ± 1 %
Auxiliary supply frequency	Rated Value ± 1 %

### Nominal range of use of influence quantities for measurands

PGDA : Current	5 ... 120 % of Rated Value
Optional: PGDA (Max 200% Input) : Current	5 ... 200 % of Rated Value
PGDV : Voltage	10 ... 120 % of Rated Value
Input frequency	Rated Value ± 10 %
Temperature	0 to 50°C
Auxiliary supply voltage	Rated Value ± 5 %
Auxiliary supply frequency	Rated Value ± 10 %

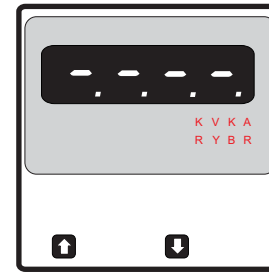

### Password Incorrect.

This screen indicates that the unit has not accepted the Password entered.

Pressing the "↑" key will return to the Enter Password stage.

Pressing the "↓" key exits the Password menu and returns to the Measurement mode.

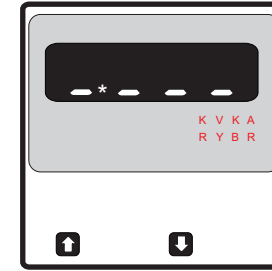

### New / Change Password

(\*Decimal point indicates that this will be flashing). Pressing the "↑" key will scroll the value of the first digit from 0 through to 9, the value will wrap from 9 round to 0.

Pressing the "↓" key to advance the operation to the next digit and sets the first digit.

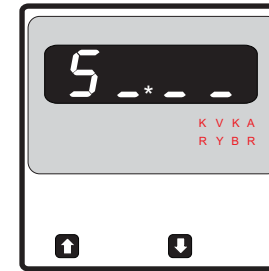

New / Change Password, first digit entered, prompting for second digit. (\*Decimal point indicates that this will be flashing).

Pressing the "↑" key will scroll the value of the Second digit from 0 through to 9, the value will wrap from 9 round to 0.

Pressing the "↓" key to advance the operation to the next digit and sets the second digit,

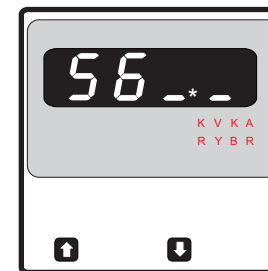

New / Change Password, second digit entered, prompting for third digit. (\*decimal point indicates that this will be flashing).

Pressing the "↑" key will scroll the value of the third digit from 0 through to 9, the value will wrap from 9 round to 0.

Pressing the "↓" key to advance the operation to the next digit and sets the third digit,

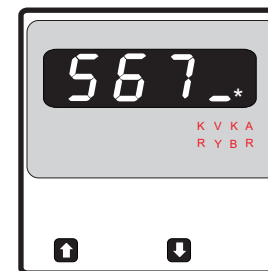

New / Change Password, third digit entered, prompting for fourth digit. (\* denotes that decimal point will be flashing).

Pressing the "↑" key will scroll the value of the fourth digit from 0 through to 9, the value will wrap from 9 round to 0.

Pressing the "↓" key to advance the operation to the "New Password Confirmation" screen and sets the fourth digit,

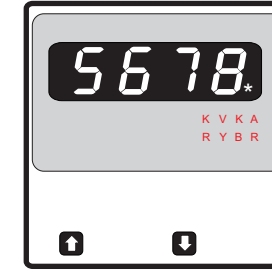

New / Change Password, fourth digit entered, Awaiting for confirmation  
Pressing the "↓" key to advance the operation to the "New Password Confirmation" screen and sets the fourth digit,

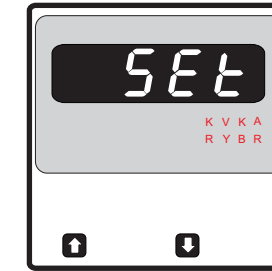

### New Password confirmation

Pressing the "↑" key will return to the "New/Change Password".

Pressing the "↓" key will Set the new Password and advances to the Set up screen. (see section 3.2).

## 3.2 Set Up Screens

### 3.2.1. Potential Transformer Primary Value (for PGDV models)

The nominal full scale voltage which will be displayed as the Line to neutral voltage. This screen is displayed followed by "PtPr" on display and enables user to display Line to Neutral Voltages inclusive of any PT ratio from **60V to 999kV**.

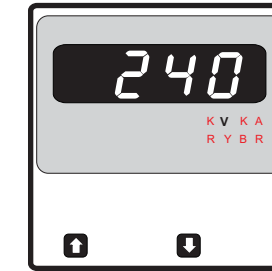

Pressing the "↓" key accepts the present value and advances to the "Potential Transformer secondary value Edit" menu. (See Section 3.2.2)

Pressing the "↑" key will enter the "Potential transformer Primary Value Multiplier Selection.

Initially the "multiplier must be selected. Pressing the "↑" Key will move the decimal point position to the right Side and show ##.#., after which it will again return to #.# with Annunciation of "K", which indicates the value in kV.

Pressing the "↓" key accepts the present multiplier (Decimal Point position) and advances to the "Potential Transformer value Edit" menu.

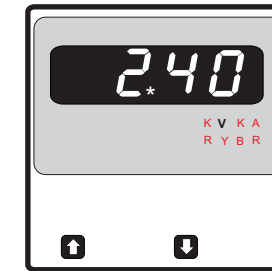

### Potential Transformer value Edit

Pressing the "↑" key will scroll the value of the most significant digit (100s) from 0 through to 9.

Pressing the "↓" key accepts the present value at the cursor position and advances the cursor to the next Less significant digit.

When the least significant digit has been set, pressing the "↓" key will advance to the "Potential transformer Primary Value Confirmation" screen.

*Note : the flashing decimal point indicates the cursor position, a steady decimal point will be present to identify the scaling of the number until the cursor position coincides with the steady decimal point position. At this stage the decimal point will be flashing.*

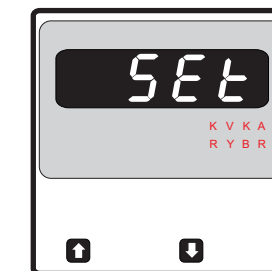

### Potential Transformer Primary Value Confirmation

This screen will only appear following an edit of the Potential Transformer Primary Value followed by "ULN" on Display.

If the set value is to be corrected, pressing the "↑" key will return to the "Potential Transformer Primary Value Edit" stage.

Pressing the "↓" key sets the value and then advance to the Potential Transformer Secondary Value edit screen (See section 3.2.2.)

### 3.2.2 Potential Transformer Secondary Value (for PGDV models)

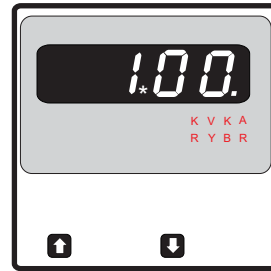

This screen is displayed after PT primary value set followed by "Pt-S" it automatically goes to value edit. Pressing "↓" key accepts the present value and then advances to RESET menu (section 3.2.5). Pressing the "↑" key will enter the PT secondary value edit mode. \* denotes that the decimal point will be flashing.

Pressing "↑" will scroll the digit 0 through 9 and back to 0, except Most Significant Digit, in which the Value will be scrolled from 0 through 2 and back to 0.

**Secondary value can be set from 60V to 290VL-N.**

Pressing the "↑" key will move cursor to next Digit. When Value of Least significant digit is set pressing "↓" Will enter Secondary value confirmation screen.

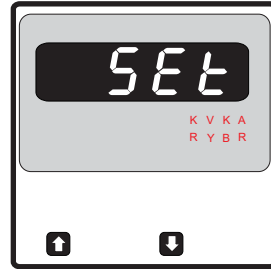

#### PT secondary value Confirmation

This screen will appear following the edit of PT secondary in above screen.

Pressing the "↓" key set the value and will advance to Reset of min / max values selection menu. (See section 3.2.5)

Pressing the "↑" key re-enter Potential Transformer Value edit menu.

### 3.2.3 Current Transformer Primary Value (for PGDA models)

The nominal full scale Current which will be displayed Phase current for both system types. This screen enables user to display Line current inclusive of any CT Ratio **1 upto 999kA.**

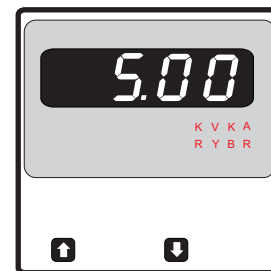

Pressing the "↓" key accepts the present value and advances to the "Current Transformer secondary value Edit" menu. (See Section 3.2.4)

Pressing the "↑" key will shift decimal point position from 100s to 1s digit. After 1s position it again shifts the position to 100s digit with annunciation of "K". It indicates the value in kA.

Pressing the "↓" key accepts the decimal point position and enters into Current Transformer Primary value edit.



#### Current Transformer value Edit

Pressing the "↑" key will scroll the value of the most significant digit (100s) from 0 through to 9.

Pressing the "↓" key accepts the present value at the cursor position and advances the cursor to the next Least significant digit.

*Note : the flashing decimal point indicates the cursor position, a steady decimal point will be present to identify the scaling of the number until the cursor position coincides with the steady decimal point position. At this stage the decimal point will be flashing.*

When the least significant digit has been set, pressing the "↓" key will advance to the "Current transformer Primary Value Confirmation" screen.

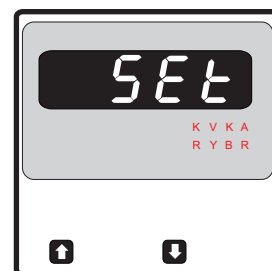

#### Current Transformer Primary Value Confirmation

This screen will only appear following an edit of the Current Transformer Primary Value.

If the set value is to be corrected, pressing the "↑" key will return to the "Current Transformer Primary Value Edit" stage.

Pressing the "↓" key sets the value and then advance to the Current Transformer Secondary Value edit screen (See section 3.2.4)

### 3.2.4 Current Transformer Secondary Value (for PGDA models)

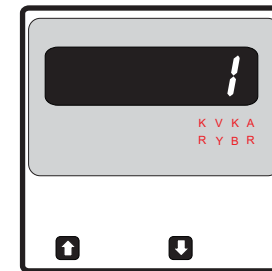

This screen is displayed after CT primary value set followed by "Ct-S" on display screen.

Pressing "↓" key accepts the present value and then advances to reset menu (section 3.2.5).

Pressing the "↑" key will scroll between 1 and 5.

When desired Current transformer secondary value selected on display, pressing "↓" will enter to CT secondary value confirmation screen.

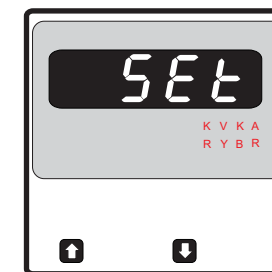

#### CT secondary value Confirmation

This screen will appear following the edit of PT secondary in above screen.

Pressing the "↓" key set the value and will advance to Reset menu (See section 3.2.5)

Pressing the "↑" key re-enter Current Transformer Value edit menu.

### 3.2.5 RESET of min / max Values

This screen is displayed after CT/PT secondary set followed by "RESET" on Display.

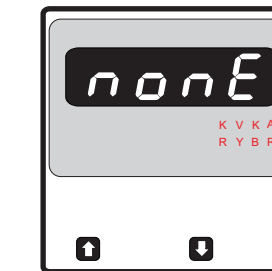

Pressing "↑" key enters into Reset menu and scrolls between the parameters as shown in the screens with pressing the key again.

Pressing "↓" key enters Screen Auto or fixed selection menu (section 3.2.6)

By selecting the parameters it resets the respective parameters as follow :

- None : No parameter reset
- ALL : Both min and max values reset
- Hi : max value reset
- Lo : min value reset

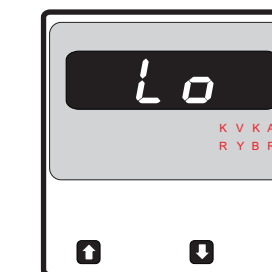
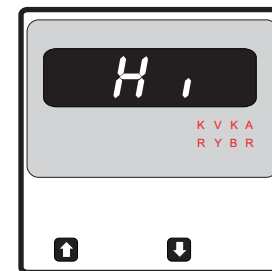
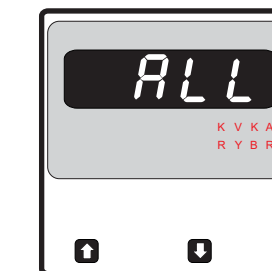

Pressing "↑" key scrolls between the screens.

Pressing "↓" selects the displayed parameter and enters to Reset parameter confirmation Screen.

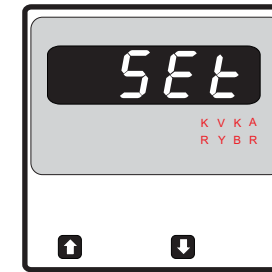

#### Reset parameter confirmation

Pressing "↑" key re-enters reset menu.

Pressing "↓" resets the selected parameter and enters to Screen Auto scrolling or fixed. Selection menu (section 3.2.6).

### 3.2.6 Selection of Auto Scrolling or fixed Screen

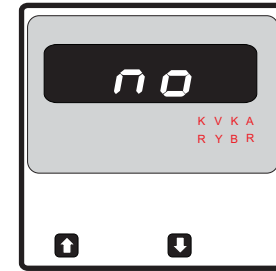

This Screen will display after PT/CT secondary value Confirmation followed by "AUtO" Display.

Pressing the "↑" key will scroll between "Yes" and "No".

Select "Yes" for Auto scrolling of parameter display and Select "No" for fixed display screen.

Pressing the "↓" key will enter into Screen selection Confirmation screen.

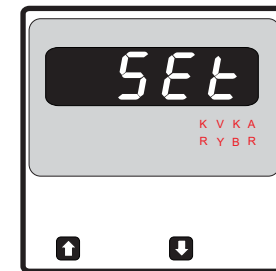

#### Auto / Fixed Screen Confirmation

Pressing the "↓" key set the selected option and Exit set up with entering into measurement mode.

Pressing the "↑" key re-enter Screen selection menu.

## 4. Installation

Mounting of PGDV/A is featured with easy "Clip-in" mounting. Push the meter in panel slot (size 92 x92 mm), it will click fit into panel with the four integral retention clips on two sides of meter.

If required Additional support is provided with swivel screws (optional) as shown in figure.

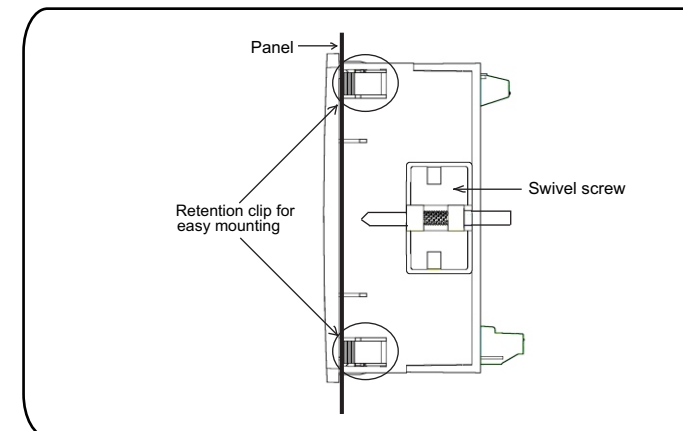

As the front of the enclosure conforms to IP50 it is protected from water spray from all directions, additional protection to the panel may be obtained by the use of an optional panel gasket. The terminals at the rear of the product should be protected from liquids.

The PGDV/A should be mounted in a reasonably stable ambient temperature and where the operating temperature is within the range 0 to 50 °C. Vibration should be kept to a minimum and the product should not be mounted where it will be subjected to excessive direct sunlight.

## Caution

1. In the interest of safety and functionality this product must be installed by a qualified engineer, abiding by any local regulations.
2. Voltages dangerous to human life are present at some of the terminal connections of this unit. Ensure that all supplies are de-energised before attempting any connection or disconnection.
3. These products do not have internal fuses therefore external fuses must be used to ensure safety under fault conditions.

## 4.1 EMC Installation Requirements

This product has been designed to meet the certification of the EU directives when installed to a good code of practice for EMC in industrial environments, e.g.

1. Screened output and low signal input leads or have provision for fitting RF suppression components, such as ferrite absorbers, line filters etc., in the event that RF fields cause problems.

**Note:** It is good practice to install sensitive electronic instruments that are performing critical functions, in EMC enclosures that protect against electrical interference which could cause a disturbance in function.

2. Avoid routing leads alongside cables and products that are, or could be, a source of interference.
3. To protect the product against permanent damage, surge transients must be limited to 2kV pk. It is good EMC practice to suppress differential surges to 2kV at the source. The unit has been designed to automatically recover in the event of a high level of transients. In extreme circumstances it may be necessary to temporarily disconnect the auxiliary supply for a period of greater than 5 seconds to restore correct operation.
4. ESD precautions must be taken at all times when handling this product.

## 4.2 Case Dimensions and Panel Cut Out

### 4.2.1 for 96X96 models

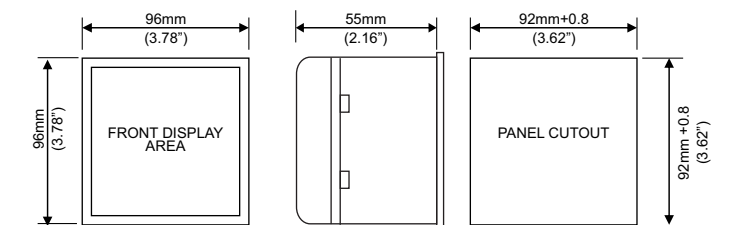

MAX PANEL THICKNESS 0.18",5mm

### 4.2.1 for 48X96 models

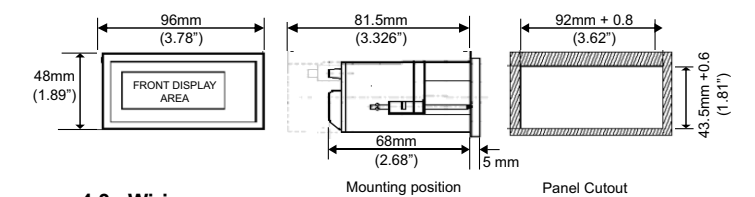

## 4.3 Wiring

Input connections are made directly to screw-type terminals with indirect wire pressure. Numbering is clearly marked on the connector. Choice of cable should meet local regulations. Terminal for inputs will accept up to 4mm<sup>2</sup> (12 AWG) or 2.5mm<sup>2</sup> (12AWG) Standard

- Note :**
- 1) It is recommended to use wire with lug for connection with meter.
  - 2) For disconnecting the device a switch or circuit-breaker shall be included at the site and it shall be within easy reach of the operator.

## 4.4 Auxiliary Supply

PGDV/A should ideally be powered from a dedicated supply, however it may be powered from the signal source, provided the source remains within the limits of the chosen auxiliary voltage.

## 4.5 Fusing

It is recommended that all voltage lines are fitted with 1 amp HRC fuse.

## 4.6 Earth/Ground Connections

For safety reasons, panels and accessories should be grounded in accordance with local regulations.