

POWER DPM 96 X96

Three Phase (3W/4W) / Single Phase (1 PH)

Power Indicator

Installation & Operating Instructions

Section	Contents
1.	Introduction
2.	Programming
3.	Phaser Diagram
4.	Case Dimensions and Panel Cut-out
5.	Installation <ul style="list-style-type: none"> 5.1 Wiring 5.2 Auxiliary 5.3 Fusing 5.4 Earth/Ground Connections
6.	Connection Diagrams
7.	EMC Installation Requirements
8.	Specification

DMAN-00IM-0055_ Rev. B 07/2020

1. Introduction

The Power DPM 96 x 96 is a panel mounted 96 x 96mm DIN Quadratic Digital Meter for the measurement of total system Power.

The instrument integrates accurate measurement technology (All Voltage & Current measurements are True RMS upto 15th Harmonic) with 1 line 4 digits Ultra high brightness LED display.

It does accurate measurement of Power which is derived from voltage & current measurement by using micro controller & solid state devices.

It also shows "-" polarity in export mode (refer phaser diagram).

Power DPM can be configured/programmed on site for PT Primary, CT Primary, CT Secondary (5A or 1A) and 3 phase 3W or 4W.

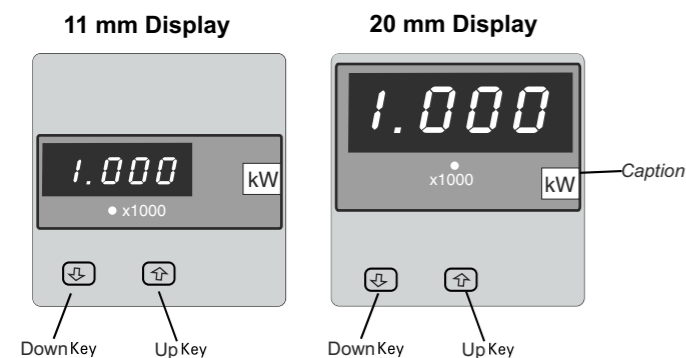

Front View of Power indicator

The front panel has two push buttons through the which user can configure the meter for user can configure the meter for PT Primary, CT Primary, CT Secondary & network.

User can also set the meter to required power measurement from configuration setup to one of the Power Active Power (kW), Reactive Power (kVar), Apparent Power (kVA) but relevant caption changes needs to be done.

Note : Message screen's of 11 mm & 20 mm are same only display aesthetic is changed

2. Programming

The following sections comprise step by step procedures for configuring the POWER DPM 96x96 for individual user requirements.

To access the set-up screens press and hold the "Down" and "Up" Key simultaneously for 5 seconds. This will take the User into the Password Protection Entry Stage (Section 2.1).

2.1. Password Protection

Password protection can be enabled to prevent unauthorised access to set-up screens, by default password protection is not enabled.

Password protection is enabled by selecting a four digit number other than 0000, setting a password of 0000 disables the password protection.

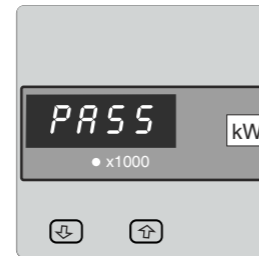

Enter Password, flashes PASS.

Enter Password, prompt for first digit. (* Denotes that decimal point will be flashing).

Press the "Down" key to scroll the value of the first digit from 0 through to 9, the value will wrap from 9 round to 0.

Press the "Up" key to advance to Up digit.

In the special case where the Password is "0000" pressing the "Up" key when prompted for the first digit will advance to the "Password Confirmed" screen.

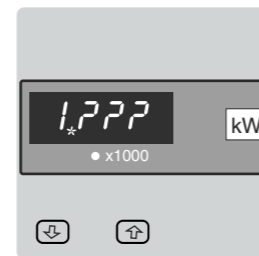

Enter Password, first digit entered, prompt for second digit. (* Denotes that decimal point will be flashing).

Use the "Down" key to scroll the value of the second digit from 0 through to 9, the value will wrap from 9 round to 0.

Press the "Up" key to advance to Up digit.

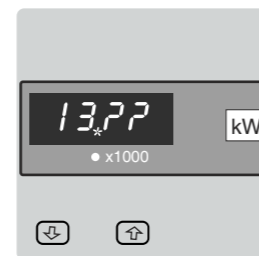

Enter Password, second digit entered, prompt for third digit. (* Denotes that decimal point will be flashing).

Use the "Down" key to scroll the value of the third digit from 0 through to 9, the value will wrap from 9 round to 0.

Press the "Up" key to advance to Up digit.

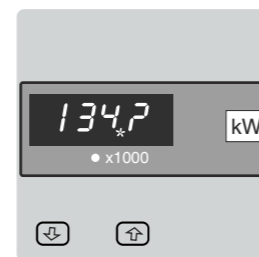

Enter Password, third digit entered, prompt for fourth digit. (* Denotes that decimal point will be flashing).

Use the "Down" key to scroll the value of the fourth digit from 0 through to 9, the value will wrap from 9 round to 0.

Press the "Up" key to advance to verification of the password.

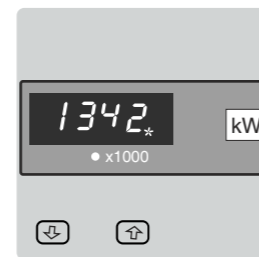

Enter Password, fourth digit entered, awaiting verification of the password.

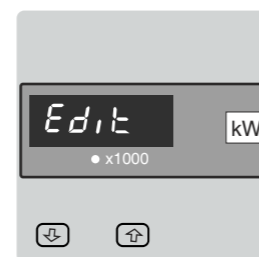

Password confirmed.

Pressing "Down" key will advance to the "New / change Password" entry stage.

Pressing the "Up" key will advance to the Set up screen. (See section 2.2).

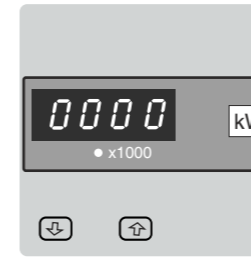

Password Incorrect.

The unit has not accepted the Password entered.

It will take you out of the setup parameter to the measurement reading mode.

Press the "Up" key & "Down" key simultaneously for 5 sec. to enter in set up again.



New / Change Password

If user wants to set password,

enter "0000" as password if user has not set any password before

Or enter valid password which is already set, to go in edit menu.

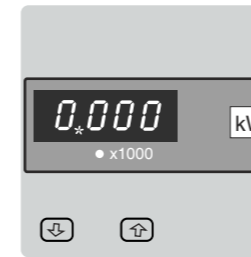

(* Denotes that decimal point is flashin be flashing). Pressing the "Down" key will scroll the value of the first digit from 0 through to 9, the value will wrap from 9 round to 0.

Pressing the "Up" key to advances the operation to the Up digit and sets the first digit, in this case to "2"

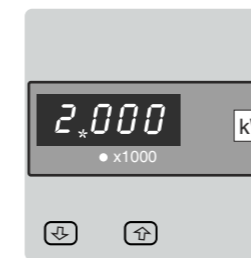

New / Change Password, first digit entered, prompting for second digit. (* Denotes that decimal point is flashin be flashing).

Pressing the "Down" key will scroll the value of the second digit from 0 through to 9, the value will wrap from 9 round to 0.

Pressing the "Up" key advances the operation to the Up digit and sets the second digit, in this case to "1"



New / Change Password, second digit entered, prompting for third digit. (*decimal point indicates that this will be flashing).

Pressing the "Down" key will scroll the value of the third digit from 0 through to 9, the value will wrap from 9 round to 0.

Pressing the "Up" key advances the operation to the Up digit and sets the third digit, in this case to "5"



New / Change Password, third digit entered, prompting for fourth digit. (* denotes that decimal point will be flashing).

Pressing the "Down" key will scroll the value of the fourth digit from 0 through to 9, the value will wrap from 9 round to 0.

Pressing the "Up" key advances the operation to the "New Password Confirmed" and sets the fourth digit, in this case to "3".



New Password confirmed.

Pressing the "Down" key will return to the "New/Change Password".

Pressing the "Up" key will advances to the Set up screen. (see section 2.2).

2.2 Set Up Screens

2.2.1. System Type

This screen is not applicable for 1 PH. meter.

This screen flashes "555" for system type.

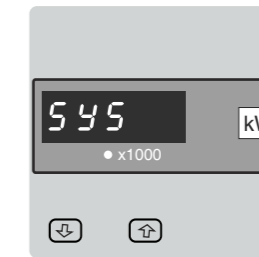

This menu is used to set the system type. System type "3" for 3 phase 3 wire & "4" for 3 phase 4 wire system.

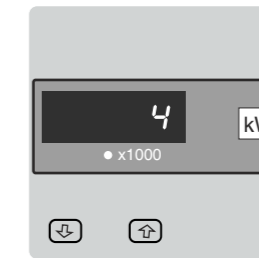

Pressing the "Up" key accepts the present value and advances to the "Potential transformer primary value Edit" menu (see section 2.2.2)

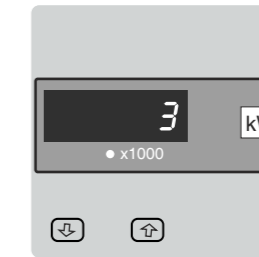

Pressing the "Down" key will enter the system type edit mode and scroll the values through values available(3 or 4).

System Type Confirmation

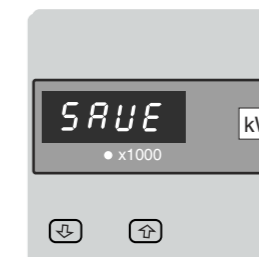

pressing the "Up" key sets the displayed value and will advance to system type "save" screen.

This screen will only appear following the edit of system type. If system type is to be changed again, pressing the "Down" key will return to the system type edit stage.

pressing the "Up" key sets the displayed value and will advance to "Potential Transformer Primary Value Edit" menu. (See section 2.2.2)

2.2.2. Potential Transformer Primary Value

The nominal full scale voltage which will be displayed as the L1-N, L2-N and L3-N for a four wire (Ln) system or as L1-2, L2-3 and L3-1 in a three wire(LL) system. This screen enables the user to set the line to neutral and line to line voltages inclusive of any transformer ratios, the values displayed represent the voltage in kilovolts (note the x1000 annunciator).

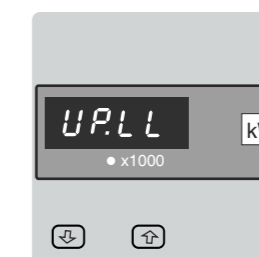

This screen flashes following message

It indicates "U.P.L.L" for line to line (L-L) voltage for 3phase.

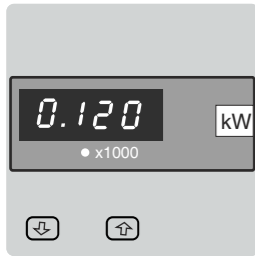

Pressing the "Up" key accepts the present value and advances to the "Current Transformer Primary Value edit" menu. (See Section 2.2.3)

Pressing the "Down" key will enter the "Potential Transformer Primary Value Edit" mode.

Initially the multiplier must be selected, pressing the "Down" key will move the decimal point position to the right until it reaches ### after which it will return to ###.

Pressing the "Up" key accepts the present multiplier (decimal point position) and advances to the "Potential Transformer Digit Edit" mode.

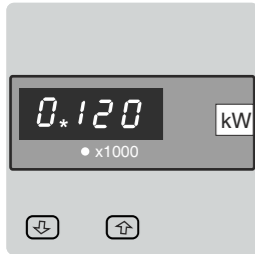

Potential Transformer Digit Edit

Pressing the "Down" key will scroll the value of the most significant digit from 0 through to 9 unless the presently displayed Potential Transformer Primary Value together with the Current Transformer Primary Value, previously set, would result in a maximum power of greater than 1000 MVA in which case the digit range will be restricted.

Pressing the "Up" key accepts the present value at the cursor position and advances the cursor to the Up least significant digit. (* Denotes that decimal point will be flashing).

Note : 0.120 kV i.e. 120 V_{L-L} for 3PH3W and 3PH4W
Note : 0.120 kV i.e. 120 V_{L-N} for 1PH2W

The "Maximum Power" restriction of 1000 MVA refers to 120% of nominal current and 120% of nominal voltage, i.e., 694.4 MVA nominal system power.

Note : the flashing decimal point indicates the cursor position, a steady decimal point will be present to identify the scaling of the number until the cursor position coincides with the steady decimal point position. At this stage the decimal point will flash.

When the least significant digit has been set pressing the "Up" key will advance to the "Potential Transformer Primary Value Confirmation" stage.

Screen showing display of 0.120 kV i.e. 120 Volts indicating steady decimal point and cursor flashing at the "hundreds of volts" position.

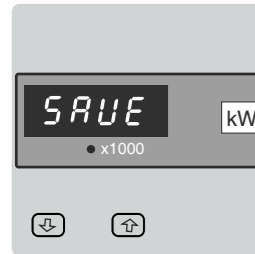

Potential Transformer Primary Value Confirmation

This screen will only appear following an edit of the Potential Transformer Primary Value.

If the scaling is not correct, pressing the "Down" key will return to the "Potential Transformer Primary Value Edit" stage with the digits flashing indicating that the multiplier (decimal point position) should be selected.

Pressing the "Up" key sets the displayed value and will advance to the Current Transformer Primary Value (See section 2.2.3.)

2.2.3. Current Transformer Primary Value

The nominal Full Scale Current that will be displayed as the Line currents. This screen enables the user to display the Line currents inclusive of any transformer ratios, the values displayed represent the Current in Amps.

Pressing the "Up" key accepts the present value and advances to the Current Transformer Secondary Value (See section 2.2.4)

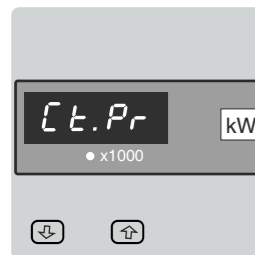

This screen flashes for "CT Primary" menu & preset "CT Primary" value is displayed.

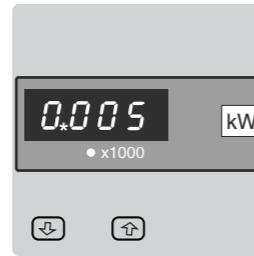

Pressing the "Down" key will enter the "Current Transformer Primary Value Edit" mode. This will scroll the value of the most significant digit from 0 through to 9, unless the presently displayed Current Transformer Primary Value together with the Potential Transformer Primary Value results in a maximum power of greater than 1000 MVA in which case the digit range will be restricted, the value will wrap. Example: If primary value of PT is set as 692.8kV_{L-L} (400kV_{L-N} max value) then primary value of Current is restricted to 0578A.

Pressing the "Up" key will advance to the least significant digit. (* Denotes that decimal point will be flashing).

The "Maximum Power" restriction of 1000 MVA refers to 120% of nominal current and 120% of nominal voltage, i.e., 694.4 MVA nominal system power.

When the least significant digit had been set, pressing the "Up" key will advance to the "Current Transformer Primary Value Confirmation" stage.

The minimum value allowed is 1, the value will be forced to 1 if the display contains zero when the "Up" key is pressed.

Current Transformer Primary Value Confirmation.

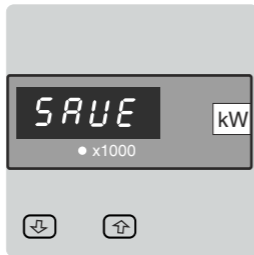

This screen will only appear following an edit of the Current Transformer Primary Value.

If the scaling is not correct, Pressing the "Down" key will return to the "Current Transformer Primary Value Edit" stage with the most significant digit highlighted (associated decimal point flashing)

Pressing the "Up" key sets the displayed value and will advance to the "Current Transformer Secondary Value Edit" menu. (See section 2.2.4).

2.2.4. Current Transformer Secondary Value

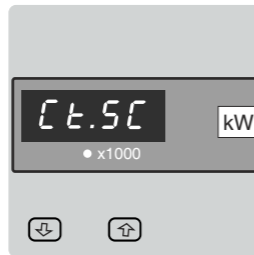

This screen is used to set the secondary value for Current Transformer. Secondary value "5" for 5A or "1" for 1A can be selected.

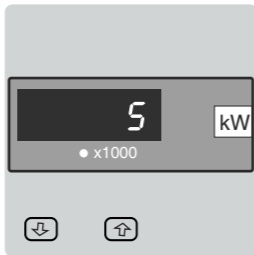

Pressing "Up" key accepts the present value and advances to the Pulse Rate edit menu (See section 3.2.5).

Pressing the "Down" key will enter the CT Secondary value edit mode and scroll the value through "1" or "5".

Pressing the "Up" key will advance to the CT Secondary value confirmation.

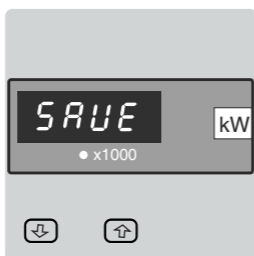

CT Secondary value confirmation

This screen will only appears following an edit of CT secondary value .

If secondary value shown is not correct, pressing the Down key will return to CT secondary edit stage.

Pressing "Up" key sets the displayed value and will advance to Power selection menu. (See section 2.2.5)

2.2.5. Power selection

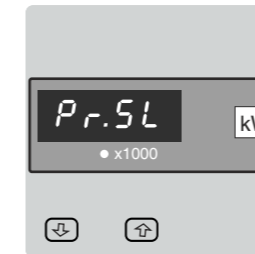

This screen allows user to set required power measurement . User can set one of the following power for measurements
1) Active Power (kW)
2) Reactive Power (kVA)
3) Apparent Power (kVA)

← Caption

Note : When user changes the power to be measured relevant Power measurement unit should be modified (I.e. Caption to be modified)

Spare Caption are provided with instrument supplied.
CT Primary X PT Primary < 1200 then unit is W /VA /VA
CT Primary X PT Primary > 1200 then unit is Kelo
CT Primary X PT Primary > 1200000 then unit is Mega

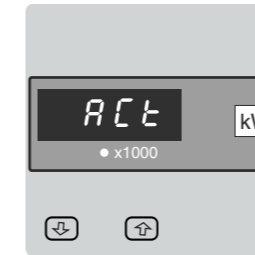

Pressing the "Down" key will enter the edit mode

Act =====> Active Power (kW)

Pressing the "Down" key will scroll through

Act -> rER -> APP

Pressing the "Up" key will set the Active power & go to measurement.

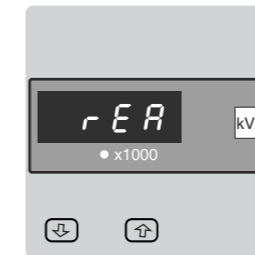

Pressing the "Down" key will enter the edit mode

rER =====> Reactive Power (kVA)

Pressing the "Up" key will set the reactive power & go to measurement.

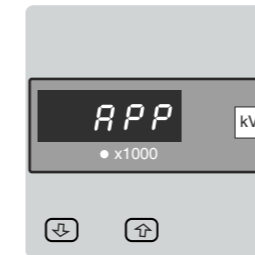

Pressing the "Down" key will enter the edit mode

APP =====> Apparent Power (kVA)

Pressing the "Up" key will set the apparent power & go to measurement.

3. Phasor Diagram : Refer the diagram for explanation

Quadrant 1: 0° to 90°
Quadrant 2: 90° to 180°
Quadrant 3: 180° to 270°
Quadrant 4: 270° to 360°

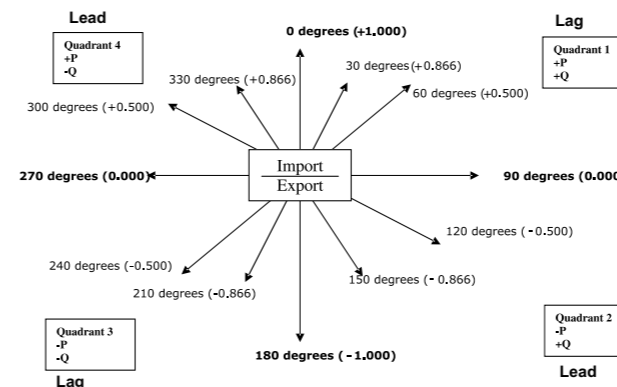

Connections	Quadrant	Sign of Active Power (P)	Sign of Reactive Power (Q)	Sign of Power Factor (PF)	Lag /Lead
Import	1	+ P	+ Q	+	Lag
Import	4	+ P	- Q	+	Lead
Export	2	- P	+ Q	-	Lead
Export	3	- P	- Q	-	Lag

Lag (Inductive) means Current lags Voltage
Lead (Capacitive) means Current leads Voltage

When Power DPM displays Active power (P)with " + " (positive sign) , the connection is " **Import** " .

When Power DPM displays Active power (P)with " - " (negative sign) , the connection is " **Export** " .

4. Case Dimension and Panel Cut Out

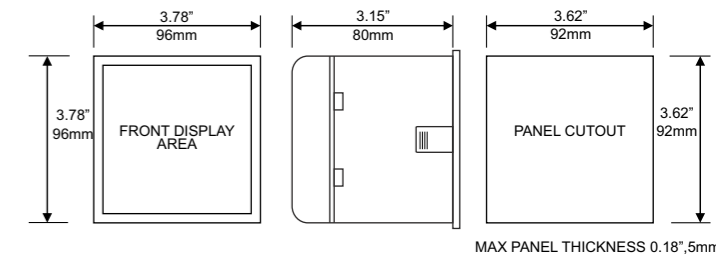

5. Installation

Mounting is by four side clamps, slide the side clamps through side slot till side clamp gets firmly locked in a groove (Refer fig.) Consideration should be given to the space required behind the instrument to allow for bends in the connection cables.

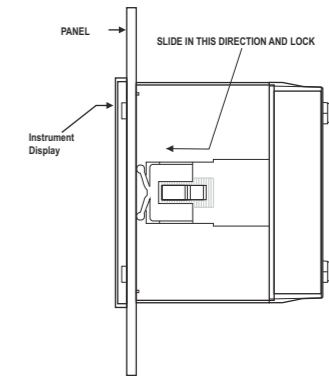

As the front of the enclosure conforms to IP54 it is protected from water spray from all directions, additional protection to the panel may be obtained by the use of an optional panel gasket. The terminals at the rear of the product should be protected from liquids.

The meter should be mounted in a reasonably stable ambient temperature and where the operating temperature is within the range -10 to 55°C . Vibration should be kept to a minimum and the product should not be mounted where it will be subjected to excessive direct sunlight.

Caution

- In the interest of safety and functionality this product must be installed by a qualified engineer, abiding by any local regulations.
- Voltages dangerous to human life are present at some of the terminal connections of this unit. Ensure that all supplies are de-energised before attempting any connection or disconnection.
- These products do not have internal fuses therefore external fuses must be used to ensure safety under fault conditions.

5.1 Wiring

Input connections are made directly to screw-type terminals with indirect wire pressure. Numbering is clearly marked in the plastic moulding. Choice of cable should meet local regulations. Terminal for both Current and Voltage inputs will accept upto 3mm x 2 diameter cables.

Note : It is recommended to use wire with lug for connection with meter.

5.2 Auxiliary Supply

The meter should ideally be powered from a dedicated supply, however it may be powered from the signal source, provided the source remains within the limits of the chosen auxiliary voltage.

5.3 Fusing

It is recommended that all voltage lines are fitted with 1 amp HRC fuses.

5.4 Earth/Ground Connections

For safety reasons, CT secondary connections should be grounded in accordance with local regulations.

6. Connection Diagrams

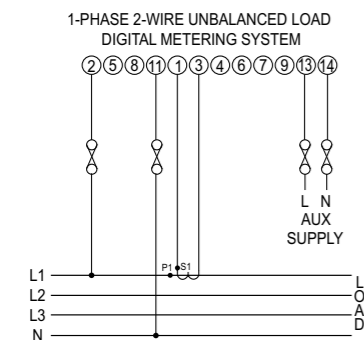
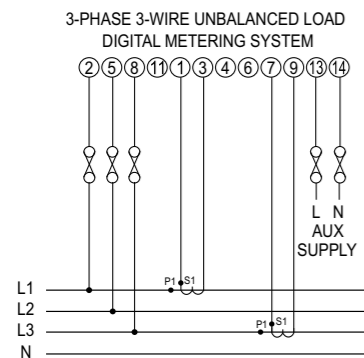
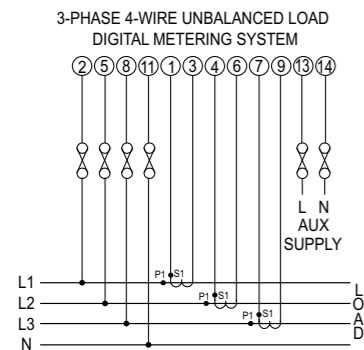

7. EMC Installation Requirements

This product has been designed to meet the certification of the EU directives when installed to a good code of practice for EMC in industrial environments, e.g.

1. Screened output and low signal input leads or have provision for fitting RF suppression components, such as ferrite absorbers, line filters etc., in the event that RF fields cause problems.

Note: It is good practice to install sensitive electronic instruments that are performing critical functions, in EMC enclosures that protect against electrical interference which could cause a disturbance in function.

2. Avoid routing leads alongside cables and products that are, or could be, a source of interference.
3. To protect the product against permanent damage, surge transients must be limited to 2kV pk. It is good EMC practice to suppress differential surges to 2kV at the source. The unit has been designed to automatically recover in the event of a high level of transients. In extreme circumstances it may be necessary to temporarily disconnect the auxiliary supply for a period of greater than 5 seconds to restore correct operation.
The Current inputs of these products are designed for connection in to systems via Current Transformers only, where one side is grounded.
4. ESD precautions must be taken at all times when handling this product.

8. Specification

Inputs

Nominal input voltage	57.7 V _{L-N} to 277V _{L-N} (100V _{L-L} to 480 V _{L-L})
Max continuous input voltage	120% of Rated Value
Max short duration input voltage	2 x Rated Value (1s application repeated 10 times at 10s intervals)
Nominal input voltage burden	0.2VA approx. per phase
Nominal input current	1A or 5A AC rms (Programmable)
Max continuous input current	120% of Rated Value
Nominal input current burden	0.6VA approx. per phase
Max short duration current input	20 x Rated Value (1s application repeated 5 times at 5 min. intervals)

Auxiliary

Standard nominal a.c. supply voltages	110V , 230V ,380V AC, 100 - 250V AC-DC 12 - 48V DC
a.c. supply voltage tolerance	+20 % / -15 % of Rated Value
a.c. supply frequency range	45 to 66 Hz
a.c. supply burden	4.0VA
d.c. supply burden	3W

Operating Ranges

Voltage	5 .. 120 % of Rated Value
Current	5 .. 120 % of Rated Value
Frequency	40 .. 70 Hz
Power Factor	0.5 Lag ... 1 ... 0.5 Lead

Accuracy

Active Power, Apparent Power	± 0.5% of range (50.....100% of rated value)
Reactive Power	± 1.0% of range (50.....100% of rated value)

Reference conditions for Accuracy :

Reference temperature	23°C ± 2°C
Input frequency	50 or 60Hz ± 2%
Input waveform	Sinusoidal (distortion factor 0.005)
Auxiliary supply voltage	Rated Value ± 1 %
Auxiliary supply frequency	Rated Value ± 1 %
Power Factor	0.5 lag 1 0.5 lead

Nominal range of use of influence quantities for measurands

Voltage	50 .. 120 % of Rated Value
Current	10 .. 120 % of Rated Value
Input frequency	Rated Value ± 10 %
Temperature	0 to 50°C
Auxiliary supply voltage	Rated Value ± 10 %
Auxiliary supply frequency	Rated Value ± 10 %
Temperature Coefficient (For Rated value range of use 0... 50°C)	0.075% /°C
Error change due to variation of an influence quantity	2 * Error allowed for the reference condition applied in the test.

Display

LED	Single line 4 digits Digit height 11mm / 20mm
Resolution	0.001

Isolation

Dielectric voltage withstand test between circuits and accessible surfaces	2.2 kV RMS 50 Hz for 1 minute between all electrical circuits
--	---

Standards

EMC Immunity	IEC 61326 10V/m min-Level 3 industrial low level electromagnetic radiation environment IEC 61000-4-3.
Safety	IEC 61010-1 , Year 2001
IP for water & dust	IEC 60529

Environmental

Operating temperature	-10 to 55 °C
Storage temperature	-20 to +65°C
Relative humidity	0 .. 90 % RH
Warm up time	3 minute (minimum)
Shock	15g in 3 planes
Vibration	10 .. 55 Hz, 0.15mm amplitude
Enclosure (front only)	IP 54 as per IEC 60529

Enclosure

Style	96mm x 96mm DIN Quadratic
Material	Polycarbonate Housing , Self extinguish & non dripping as per UL 94 V-0
Terminals	Screw-type terminals
Depth	< 80 mm
Weight	0.620 kg Approx.

Notes :