

RISH EM 3490

RISH EM 3490

Single Phase Energy Meter - Counter Type Installation & Operating Instructions

Section	Contents
1.	Introduction
2.	LED Indications
3.	CT Ratio setting using Thumbwheel 3.1 Programming and Lock mode
4.	Pulse Output (Relay)
5.	Installation 5.1 Case Dimensions and Panel Cut-out 5.2 Wiring 5.3 Fusing 5.4 Earth / Ground Connections
6.	Connection Diagrams
7.	Specification
8.	Connection for Pulse Output.



15000224 / Rev. A - 09/2008

1. Introduction

Rish EM 3490 is a 96mm x 96mm panel mounted kilowatt hour meter it measures active energy to class 1.0 accuracy with 7 digit auto-resetting electro-mechanical counter. The unit provides LED indication for healthy phase & load reverse current . The RISH EM 3490 is available in three version 3 phase 3 wire, 3 phase 4 wire & 1 Phase 2 wire unbalanced Load and is ideal for secondary metering in industrial applications.

Front View of Meter :

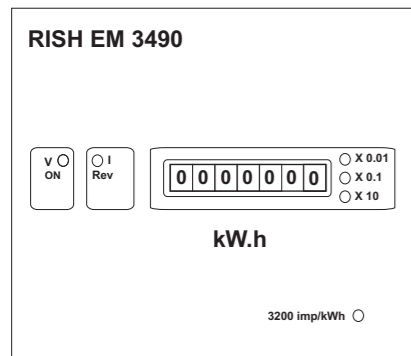

Features :

- Available in 3P4W, 3P3W & 1P2W configuration.
- LED Indication : Phase Voltage, Phase sequence & Reverse current indication.
- True RMS Measurement.
- 7 Digit auto resettable electro-mechanical counter
- Fully programmable CT Ratios by Thumb wheel switch at rear of meter
- Fully isolated current input.
- Build in transient protection.
- Pulse Output : One potential free relay contact.

2. LED Indications

A) Voltage status (VON)

LED	STATUS	CONDITION
V ON	Green LED ON (Steady)	Phase Present
	Green LED OFF	Phase Absent

B) Reverse connected Current Transformers (I Rev) (Import / Export Connection)

LED	STATUS	CONDITION
IRev	Red LED ON	CT Connection reversed for the Phase For measurement of Export Energy.
	Red LED OFF	CT Connection correct for the Phase For measurement of Import Energy.

Note : Meter will correctly record Energy in both the direction Import as well as Export connection.

C) Impulse LED

LED	STATUS	CONDITION
3200 imp/kWh	Flashing RED LED	RED LED Flashes at a rate proportional to the measured power (flashing rate = 3200 imp/kWh)

Note : Impulse LED Flashing rate has been fixed at 3200 imp/kWh with different CT ratio setting, impulse rate will remain same.

D) Scaling LED

LED	STATUS	CONDITION
0.01	Red LED ON	With " X 0.01" RED LED ON, user has a resolution of 0.01 kWh (Display reading X 0.01)
0.1	Red LED ON	With " X 0.1" RED LED ON, user has a resolution of 0.1 kWh (Display reading X 0.1)
10	Red LED ON	With " X 10" RED LED ON, user has a resolution of 10 kWh (Display reading X 10)

3. CT Ratio setting using Thumbwheel :

3.1 Programming and Lock mode :

The RISH EM 3490 comes with standard CT ratio setting , if not Specified by the customer .

Front View of RISH EM 3490 after removal of Black frame & Front Glass.

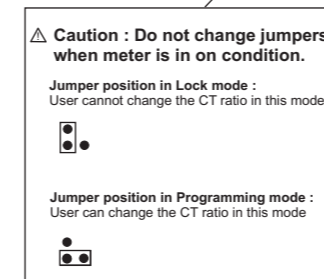
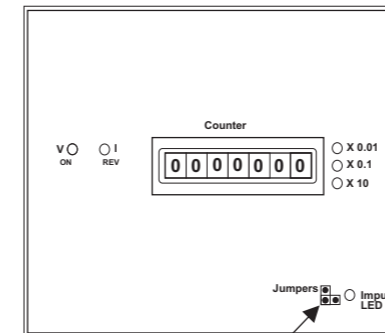

User can set the CT ratio using the Thumbwheel (4 digit) provided on rear side of Meter .

Thumbwheel



Each digit of thumbwheel having two switches (+) & (-) . User can increment the number from 0 to 9 using (+) switch or decrement the number from 9 to 0 using (-) switch .

The CT ratio can be set to any value between 0005 to 9999 for 5A or 0001 to 9999 for 1A.

If user wants to change CT ratio , then please follow the procedure given below
1) First switch OFF the input voltage of the meter .Open the front glass of meter by removing Black frame, then check the Jumper position. Initially the Jumper position is in Lock mode (Factory setting).

2) Put the Jumper in Programming mode (Unlock mode) : Then set the required CT ratio xxxx / 5A or xxxx / 1A using the Thumbwheel provided on rear side of meter & Switch ON the input voltage of meter.

3) Then Switch OFF the meter put the Jumper in Normal mode (Lock mode) and again switch ON the meter. Now the meter is ready to use with set CT ratio.

Note : Once user sets CT ratio & puts jumper in Normal mode (Lock mode), Meter will not accept any change in thumbwheel setting. If user changes the thumbwheel setting in lock mode, last set CT ratio when jumper position was in programming mode (unlock mode) will be valid. If user wants to change CT ratio ensure that procedure given above 1, 2 & 3 is followed

Table 1 : Standard CT Ratios examples for 5A

CT Ratio	Thumbwheel	Multiplier	Impulse / kWh for Pulse Output (Relay)
1 / 5A	0 0 0 1	0.01	100
2 / 5A	0 0 0 2	0.01	100
3 / 5A	0 0 0 3	0.01	100
4 / 5A	0 0 0 4	0.01	100
5 / 5A	0 0 0 5	0.01	100
10 / 5A	0 0 1 0	0.1	10
20 / 5A	0 0 2 0	0.1	10
30 / 5A	0 0 3 0	0.1	10
40 / 5A	0 0 4 0	0.1	10
50 / 5A	0 0 5 0	0.1	10
60 / 5A	0 0 6 0	0.1	10
75 / 5A	0 0 7 5	0.1	10
100 / 5A	0 1 0 0	1	1
150 / 5A	0 1 5 0	1	1
200 / 5A	0 2 0 0	1	1
250 / 5A	0 2 5 0	1	1
300 / 5A	0 3 0 0	1	1
400 / 5A	0 4 0 0	1	1
500 / 5A	0 5 0 0	1	1
600 / 5A	0 6 0 0	1	1
800 / 5A	0 8 0 0	1	1
1000 / 5A	1 0 0 0	10	0.1
1200 / 5A	1 2 0 0	10	0.1
1250 / 5A	1 2 5 0	10	0.1
1500 / 5A	1 5 0 0	10	0.1
1600 / 5A	1 6 0 0	10	0.1
2000 / 5A	2 0 0 0	10	0.1
3200 / 5A	3 2 0 0	10	0.1
5000 / 5A	5 0 0 0	10	0.1

Note : If set CT ratio is less than 0005, the meter automatically set at the default ratio 0005.

Table 2 : Standard CT Ratios examples for 1A

CT Ratio	Thumbwheel	Multiplier	Impulse / kWh for Pulse Output (Relay)
1 / 1A	0 0 0 1	0.01	100
2 / 1A	0 0 0 2	0.01	100
3 / 1A	0 0 0 3	0.01	100
4 / 1A	0 0 0 4	0.01	100
5 / 1A	0 0 0 5	0.01	100
10 / 1A	0 0 1 0	0.1	10
20 / 1A	0 0 2 0	0.1	10
30 / 1A	0 0 3 0	0.1	10
40 / 1A	0 0 4 0	0.1	10
50 / 1A	0 0 5 0	0.1	10
60 / 1A	0 0 6 0	0.1	10
75 / 1A	0 0 7 5	0.1	10
100 / 1A	0 1 0 0	1	1
150 / 1A	0 1 5 0	1	1
200 / 1A	0 2 0 0	1	1
250 / 1A	0 2 5 0	1	1
300 / 1A	0 3 0 0	1	1
400 / 1A	0 4 0 0	1	1
500 / 1A	0 5 0 0	1	1
600 / 1A	0 6 0 0	1	1
800 / 1A	0 8 0 0	1	1
1000 / 1A	1 0 0 0	10	0.1
1200 / 1A	1 2 0 0	10	0.1
1250 / 1A	1 2 5 0	10	0.1
1500 / 1A	1 5 0 0	10	0.1
1600 / 1A	1 6 0 0	10	0.1
2000 / 1A	2 0 0 0	10	0.1
3200 / 1A	3 2 0 0	10	0.1
5000 / 1A	5 0 0 0	10	0.1

Note : The CT ratio can be set to any value between 0001 to 9999 for 1A meter .

4. Pulse Output (Relay):

RISH EM 3490 has a Pulse output. The pulse output gives pulses at the rate proportional to the measured energy & is potential free NO contact. The Pulse Output (Relay) is configured to measure Active energy. Impulses/kWh of pulse output will be same as the Mechanical counter output refer "Table 1 : Standard CT Ratios" for impulses / kWh on pulse output. Impulses / kWh will be scaled according to CT ratio.

Rear View of RISH EM 3490

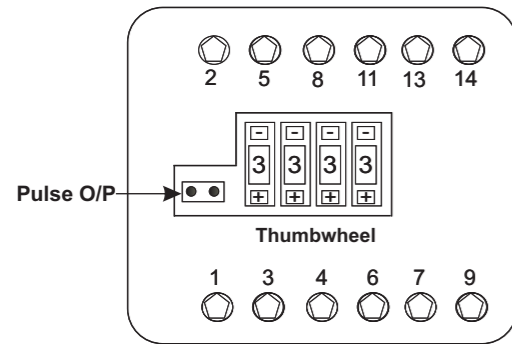

5. Installation

Mounting is by four side clamps, slide the side clamps through side slot till side clamp gets firmly locked in a groove (Refer fig.) Consideration should be given to the space required behind the instrument to allow for bends in the connection cables.

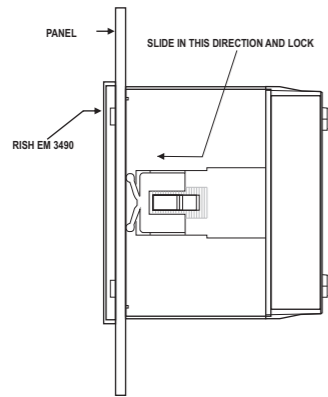

The **Rish EM 3490** should be mounted in a reasonably stable ambient temperature and where the operating temperature is within the range 0 to 55°C . Vibration should be kept to a minimum and the product should not be mounted where it will be subjected to excessive direct sunlight.

Caution

- In the interest of safety and functionality this product must be installed by a qualified engineer, abiding by any local regulations.
- Voltages dangerous to human life are present at some of the terminal connections of this unit. Ensure that all supplies are de-energised before attempting any connection or disconnection.
- These products do not have internal fuses therefore external fuses must be used to ensure safety under fault conditions.

5.1 Case Dimension and Panel Cut Out

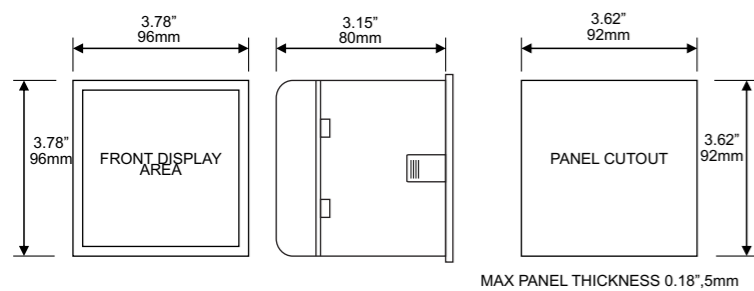

5.2 Wiring

Input connections are made directly to screw-type terminals with indirect wire pressure. Numbering is clearly marked in the plastic moulding. Choice of cable should meet local regulations. Terminal for both Current and Voltage inputs will accept upto 3mm² x 2 diameter cables.

Note : It is recommended to use wire with lug for connection with meter.

5.3 Fusing

It is recommended that all voltage lines are fitted with 1 amp HRC fuses.

5.4 Earth/Ground Connections

For safety reasons, CT secondary connections should be grounded in accordance with local regulations.

6. Connection Diagrams

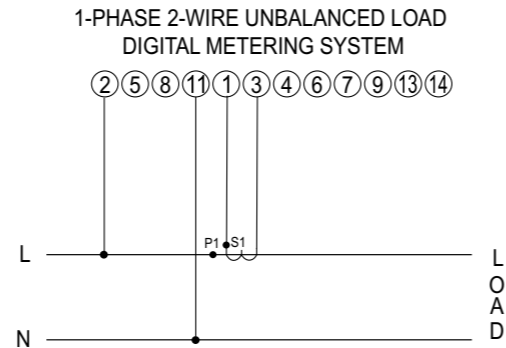

Note : Never interchange Neutral connection with Phase it can damage the meter.

7. Specification

System	1 Phase 2 Wire
Input	
Nominal input Voltage	Single Phase 110 V _{r.m.s} (99 V _{r.m.s} to 121V _{r.m.s}) 240 V _{r.m.s} (216 V _{r.m.s} to 264V _{r.m.s})
Max continuous input voltage	110% of Rated Value
Input Frequency	45 to 55 Hz
Nominal input voltage burden	< 15 VA per phase
Nominal input current Burden	< 0.2 VA per phase
Nominal input current	5A or 1A AC rms
Max continuous input current	120 % Rated Value
Start up current	0.2% of the rated current
Max short duration current input	20 x Rated Value (for 0.5 seconds)
System CT Primary Ratios	From 5...9999 for 5A or From 1...9999 for 1A (Programmable by thumbwheel switches at rear of meter)

Auxiliary Supply

AC Auxiliary Supply	Self powered
---------------------	--------------

Operating Measuring Ranges

Voltage	Single Phase 110 V _{r.m.s} (99 V _{r.m.s} to 121V _{r.m.s}) 240 V _{r.m.s} (216 V _{r.m.s} to 264V _{r.m.s})
Current	5A (0.25A to 6A) 1A (0.05A to 1.2A)
Frequency	45 .. 55 Hz
Power Factor	0.5 inductive 1.... 0.8 capacitive

Accuracy

Active energy (kWh)	Class 1.0
---------------------	-----------

Reference Conditions for Accuracy

Reference temperature	23°C ± 2°C
Input Voltage	± 1 % of Rated Value
Input frequency	50 Hz ± 0.3 %
Input waveform	Sinusoidal (distortion factor less than 2%)

Display

Counter	7 digit auto-resetting electro-mechanical counter
---------	---

LED Indication

VON	Green LED's for Phase Voltage present
I REV	RED LED's for indicating reverse connected Current Transformer (Import or Export connection)
Impulse LED	Red LED flashing at a rate proportional to measured power. Impulse rate = 3200 imp/kWh
Scaling LED (x0.01, x0.1, x10)	Depending on Thumb wheel setting respective RED LED (Multiplier) will glow.

Pulse Output Relay :

Relay	1NO
Switching Voltage & Current	240V AC/DC , 5Amp.
Relay Constant (pulses/ kWh))	Refer Table1 & Table2

Environmental

Operating temperature	0 to 55 °C
Storage temperature	-20 to +65 °C
Relative humidity	0 90 % RH
Shock	40g in 3 planes
Vibration	10 .. 55 Hz, 0.15mm amplitude
Enclosure (front only)	IP 54 as per IEC 60529

Enclosure

Style	96 x 96 (DIN Quadratic)
Material	Polycarbonate Housing , Self extinguish & non dripping as per UL 94 V-0
Terminals	Screw type terminal
Fixing	4 side clamps

Dimension

Panel Cutout	92mm x 92mm
Weight	Approx. 0.45 kg

Applicable Standards

Standard	IS 13779, IEC62053-21
----------	-----------------------

8. Connection for Pulse Output :

Rear View of RISH EM 3490

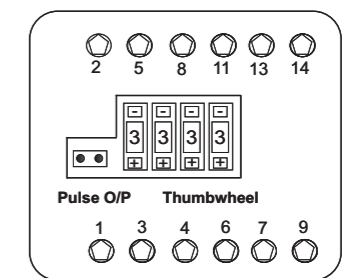

The information contained in these installation instructions is for use only by installers trained to make electrical power installations and is intended to describe the correct method of installation for this product. However, Rishabh Instruments has no control over the field conditions which influence product installation. It is the user's responsibility to determine the suitability of the installation method in the user's field conditions. Rishabh Instruments' only obligations are those in Rishabh Instruments' standard Conditions of Sale for this product and in no case will Rishabh Instruments be liable for any other incidental, indirect or consequential damages arising from the use or misuse of the products.