

Operating Manual

RISH LM 1360+



DIGITAL MULTIFUNCTION INSTRUMENT

Installation & Operating Instructions

Section	Contents
1.	Introduction
2.	Measurement and Energy/Counter Screens
	2.1 Current Reversal Screen
	2.2 Phase Rotation Error Screen
	2.3 Phase Absent Screen
	2.4 %Voltage unbalanced & % Current unbalanced screen
	2.5 Individual Harmonics
	2.6 Load Health Monitor Screen
	2.6.1 Load Health Monitor Fault Screens
	2.7 Quadrant wise Reactive Energy Measurement Screens
	2.7.1 First menu of quadrant wise reactive energy measurement screens
	2.7.2 Second menu of quadrant wise reactive energy measurement screens
	2.8 System Net Active Total Energy
	2.9 Apparent Energy while active import/export
	2.9.1 Apparent Energy while active import
	2.9.2 Apparent Energy while active export
	2.10 Pre-Paid Energy Menu
	2.11 Timer 1 & Timer 2 Screens
	2.12 Run Hour
	2.13 On Hour
	2.14 Number of Interruption
3.	Programming
	3.1 Password Protection
	3.2 Menu Selection
	3.2.1 System Parameter Selection
	3.2.1.1 System Type
	3.2.1.2 Potential Transformer Primary Value
	3.2.1.3 Potential Transformer Secondary Value
	3.2.1.4 Current Transformer Primary Value
	3.2.1.5 Current Transformer Secondary Value
	3.2.1.6 System Frequency
	3.2.1.7 Demand Integration Time
	3.2.1.8 Auto Scrolling
	3.2.1.9 Low Current Noise Cutoff
	3.2.1.10 No. of Poles
	3.2.1.11 Energy Output

- 3.2.1.12 Energy Digit Reset Count
- 3.2.1.13 Energy Rate
- 3.2.1.14 Impulse Rate
- 3.2.1.15 Max Current demand for TDD
- 3.2.1.16 Net Active Total Energy Setting
- 3.2.1.17 Version Information
- 3.2.1.18 Quit System Parameters
- 3.2.2 Communication Parameter Selection
 - 3.2.2.1 Address Setting
 - 3.2.2.2 RS 485 Baud Rate
 - 3.2.2.3 RS 485 Parity
 - 3.2.2.4 Addon Card Baud Rate
 - 3.2.2.5 Quit Communication Parameters
- 3.2.3 IP Parameter Selection
 - 3.2.3.1 IP Address Setting
 - 3.2.3.2 Subnet mask Setting
 - 3.2.3.3 Default gateway Setting
 - 3.2.3.4 Server Port Setting
 - 3.2.3.5 Quit IP Parameters
- 3.2.4 Reset Parameter Selection
 - 3.2.4.1 Resetting Parameter
- 3.2.5 Output Option Selection
 - 3.2.5.1 Relay Selection
 - 3.2.5.1.1 Relay 1 or 2 Output Selection Menu
 - 3.2.5.1.1.0 None Output
 - 3.2.5.1.1.1 Pulse Output
 - 3.2.5.1.1.1.1 Parameter Selection
 - 3.2.5.1.1.1.2 Pulse Duration
 - 3.2.5.1.1.1.3 Pulse Rate
 - 3.2.5.1.1.1.4 Quit Pulse Output
 - 3.2.5.1.1.2 Limit Output
 - 3.2.5.1.1.2.1 Limit Output Parameters
 - 3.2.5.1.1.2.2 Alarm Configuration
 - 3.2.5.1.1.2.3 Trip Point
 - 3.2.5.1.1.2.4 Hysterisis
 - 3.2.5.1.1.2.5 Energy Trip Point
 - 3.2.5.1.1.2.6 Logic Operation Selection
 - 3.2.5.1.1.2.7 Relay Configuration
 - 3.2.5.1.1.2.8 Limit Output ON Delay

- 3.2.5.1.1.2.9 Limit Output OFF Delay
- 3.2.5.1.1.2.10 Quit Limit Output
- 3.2.5.1.1.3 Timer
 - 3.2.5.1.1.3.1 Number of Cycles
 - 3.2.5.1.1.3.2 Timer Configuration
 - 3.2.5.1.1.3.3 On Delay
 - 3.2.5.1.1.3.4 Off Delay
 - 3.2.5.1.1.3.5 Quit Timer Output
- 3.2.5.1.1.4 Health Monitor Output
 - 3.2.5.1.1.4.1 Health Monitor Configuration
- 3.2.5.1.1.5 Pre Paid Energy Output
 - 3.2.5.1.1.5.1 Parameter Selection
 - 3.2.5.1.1.5.2 Unit Cost
 - 3.2.5.1.1.5.3 Topup Recharge
 - 3.2.5.1.1.5.4 New Recharge
 - 3.2.5.1.1.5.5 Quit Pre Paid Energy Output
- 3.2.5.1.1.6 RTC Relay
 - 3.2.5.1.1.6.1 Weekdays Selection
 - 3.2.5.1.1.6.2 Relay Configuration
 - 3.2.5.1.1.6.3 On time
 - 3.2.5.1.1.6.4 Off time
 - 3.2.5.1.1.6.5 Quit RTC Output
- 3.2.6 Health Monitor Parameters Selection
 - 3.2.6.1 Unbalance Voltage Limit
 - 3.2.6.2 Unbalance Current Limit
 - 3.2.6.3 Under Frequency Limit
 - 3.2.6.4 Under Voltage Limit
 - 3.2.6.5 Over Voltage Limit
 - 3.2.6.6 Over Current Limit
 - 3.2.6.7 Quit Health Monitor
- 3.2.7 Digital Input Parameter
 - 3.2.7.1 De-Bounce Time
 - 3.2.7.2 Digital Input 1 Mode Selection
 - 3.2.7.3 Digital Input 1 Pulse Multiplier
 - 3.2.7.4 Digital Input 2 Mode Selection
 - 3.2.7.5 Digital Input 2 Pulse Multiplier
 - 3.2.7.6 Quit Digital input

- 3.2.8 Tariff Parameter
 - 3.2.8.1 Number of Tariff Selection
 - 3.2.8.2 Tariff Mode Selection
 - 3.2.8.3 Tariff Energies Selection
 - 3.2.8.4 Tariff RTC Start Time
 - 3.2.8.5 Quit Tariff
- 3.2.9 Datalog Option Selection
 - 3.2.9.1 Event Based Datalog Selection
 - 3.2.9.1.1 Event based Datalog Selection
 - 3.2.9.1.2 Quit Event Datalog
 - 3.2.9.2 Time Based Datalog Setup
 - 3.2.9.2.1 Time Based Datalog Selection
 - 3.2.9.2.2 Time Interval Selection
 - 3.2.9.2.3 Parameter Count
 - 3.2.9.2.4 Parameter Selection
 - 3.2.9.2.5 Quit Time Based Datalog
 - 3.2.9.3 Load Profile Datalog Setup
 - 3.2.9.3.1 Load Profile Datalog Selection
 - 3.2.9.3.2 Quit Load Profile Datalog Selection
 - 3.2.9.4 Quit Datalog Menu
- 3.2.10 Display Parameters
 - 3.2.10.1 Feature Selection Menu
 - 3.2.10.1.1 Backlit
 - 3.2.10.1.2 User Assignable Screens
 - 3.2.10.1.2.1 Screen Number Selection
 - 3.2.10.1.2.2 User Screens Selection
 - 3.2.10.1.2.3 Quit User Screens
 - 3.2.10.1.3 Contrast
 - 3.2.10.1.4 Display Test Screen
 - 3.2.10.1.5 Quit Display Parameters
- 3.2.11 RTC Setting Screens
 - 3.2.11.1 Date Settings
 - 3.2.11.2 Time Settings
 - 3.2.11.3 Quit RTC
- 3.2.12 Factory Reset
 - 3.2.12.1 Factory Reset Selection
- 3.2.13 Setup Quit

4. Programmable unit format for power and voltage
5. Energy Auto-Ranging On Display
 - 5.1 Calculating Display energy (Auto-ranging)
 - 5.2 Entering Energy start count
6. Relay Output
 - 6.1 Pulse Output
 - 6.2 Limit Switch
 - 6.3 Timer Output
 - 6.4 Health Monitor Output
 - 6.5 Pre-Paid Energy Output
 - 6.6 RTC Relay
7. Phasor Diagram
8. Installation
 - 8.1 EMC Installation Requirements
 - 8.2 Case Dimensions and Panel Cut-out
 - 8.3 Wiring
 - 8.4 Auxiliary Supply
 - 8.5 Fusing
 - 8.6 Earth / Ground Connections
9. Connection Diagrams
10. Optional Pluggable Module
11. Specification
12. Connection for Optional Pulse Output / Digital Input / RS 485 / Ethernet Module

1. INTRODUCTION

The Multifunction Instrument is a panel mounted 96 x 96mm DIN Quadratic Digital Panel Meter, which measures important electrical parameters in 3 ph 4 wire / 3 ph 3 wire / 2 ph 2wire / 1 ph 3 wire / 1 ph 2 wire Network and replaces the multiple analog panel meters. It measures electrical parameters like AC voltage, Current, Frequency, Power, Energy (Active / Reactive / Apparent / Quadrant Wise Reactive energies), phase angle, power factor, individual harmonics & many more. The instrument integrates accurate measurement technology (All Voltages & current measurements are True RMS upto 31st Harmonic) with LCD display with backlight.

It can be configured & Programmed at site for the following : PT Primary, PT Secondary, CT Primary, CT Secondary 3 ph 4 wire / 3 ph 3 wire / 2 ph 2wire / 1 ph 3 wire / 1 ph 2 wire.

The front panel has four push buttons using which the user can scroll through different screens & configure the product. The front panel also has Impulse red led, flashing at rate proportional to measured power.

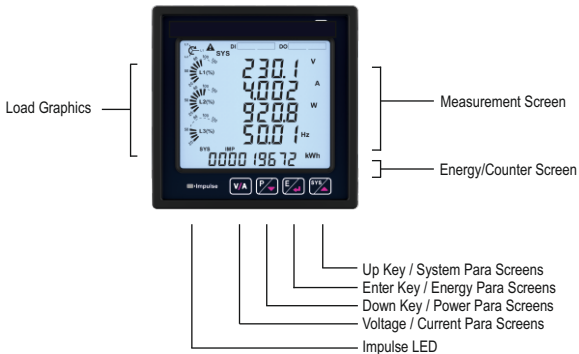

2. MEASUREMENT AND ENERGY/COUNTER SCREENS

In normal operation, the user is presented with two simultaneous screens:

1. One of the **Measurement screens** out of the screens of Table 1.1/1.3/1.4.

These screens may be scrolled through one at a time in an incremental order by pressing the respective key. Few important screens are explained in Section 2.1 to 2.6, 2.10.

2. One of the **Energy/Counter screens** out of the screens of Table 1.2.

These screens may be scrolled through one at a time in an incremental order only by pressing the "Enter key" to roll over again in the same order. Few important screens are explained in Section 2.7 to 2.9, 2.11 to 2.14

Load Graphics

Load Graphics indicates the input current as the percentage of the CT Primary value. This indication is available for all measurement screens. For example, consider CT Primary to be set at 5A, then the input current of 2.5 A indicates 50% as shown below.

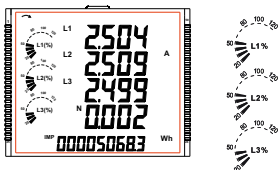

The absence of lines indicating the percentage implies that the input current is less than 20% of the CT Primary value.

Phase Sequence Indication

It indicates the rotation of input phasor vectors :
clockwise/ counter-clockwise.

In case the input is absent or the phase sequence is neither L123 nor L321, the phase sequence indication is not shown.

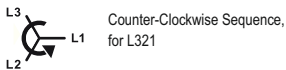
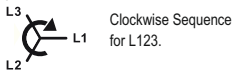

RS485 Connection Indication



It indicates that the serial communication between the instrument and the computer / control / automation system is activated through the RS485 output of the instrument by glowing continuously. In case the communication is not active, the indication is not shown.

Digital Input Indication

The Digital Input (DI) symbols indicate the following :

1. Status of external contacts when DI is configured in Status Mode.

DI 1

DI1 is configured in Status Mode and is present.

DI

DI1 is configured in Status Mode and is absent.

2. DI is configured for Pulse Mode.

DI J2L

DI2 is configured for measurement of external pulses.

Digital Output Indication

These symbols indicate the following :

1. Status of the output contacts (Relay).

DO 1

DO1 is energized.

DO

DO1 is de-energized.

2. Relay is selected in Pulse Mode.

DO J1L

DO1 is configured for Pulse Output.

Tariff Energies Indication

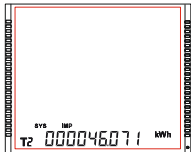

This Instrument comes with 2 tariff based on Digital Input 1 (DI1) for 6 selectable energies each. In the image given here, it indicates that the instrument is currently displaying the selected energy parameter (System Import Active Energy) of Tariff 2. Refer TABLE 1.2 for navigation of Tariff Energies. These energies are available in Energy Parameter Screens on display.

TABLE 1 : Measurement & Energy/Counter Screens
TABLE 1.1 System Parameters Screens :

Para-meter No.	Parameter	On Display					On Modbus				
		3P4W	3P3W	1P2W	1P3W	2P2W	3P4W	3P3W	1P2W	1P3W	2P2W
1	System Voltage/Current/Active-Power/Frequency	✓	✓	✓	✓	✓	✓	✓	✓	✓	✓
2	System VA/VAR/Watt/Power-Factor	✓	✓	✓	✓	✓	✓	✓	✓	✓	✓
3	System VA/VAR/Degree/Power-Factor	✓	✓	✓	✓	✓	✓	✓	✓	✓	✓
4	System RPM/Frequency	✓	✓	✓	✓	✓	✓	✓	✓	✓	✓
5	System % THD Voltage/Current	✓	✓	✓	✓	✓	✓	✓	✓	✓	✓
6	System TDD%	✓	✓	✓	✓	✓	✓	✓	✓	✓	✓
7	System VA/A Demand	✓	✓	✓	✓	✓	✓	✓	✓	✓	✓
8	System Capacitive/Inductive VAR Demand	✓	✓	✓	✓	✓	✓	✓	✓	✓	✓
9	System Import Watt Demand	✓	✓	✓	✓	✓	✓	✓	✓	✓	✓
10	System Export Watt Demand	✓	✓	✓	✓	✓	✓	✓	✓	✓	✓
11	System Max VA/A Demand	✓	✓	✓	✓	✓	✓	✓	✓	✓	✓
12	System Max Capacitive/Inductive VAR Demand	✓	✓	✓	✓	✓	✓	✓	✓	✓	✓
13	System Max Import Watt Demand	✓	✓	✓	✓	✓	✓	✓	✓	✓	✓
14	System Max Export Watt Demand	✓	✓	✓	✓	✓	✓	✓	✓	✓	✓
15	System Max Voltage/Current/Watt/Frequency	✓	✓	✓	✓	✓	✓	✓	✓	✓	✓
16	System Min Voltage/Current/Watt/Frequency	✓	✓	✓	✓	✓	✓	✓	✓	✓	✓
17	System Max VA/VAR/Watt-Power/Power-Factor	✓	✓	✓	✓	✓	✓	✓	✓	✓	✓
18	System Min VA/VAR/Watt-Power/Power-Factor	✓	✓	✓	✓	✓	✓	✓	✓	✓	✓
19	System Max VA/VAR/Power-Degree/Power-Factor	✓	✓	✓	✓	✓	✓	✓	✓	✓	✓
20	System Min VA/VAR/Power-Degree/Power-Factor	✓	✓	✓	✓	✓	✓	✓	✓	✓	✓
21	Date/Time	✓	✓	✓	✓	✓	✓	✓	✓	✓	✓
22	Timer 1 NO. of Cycle/ON Delay/OFF Delay	✓	✓	✓	✓	✓	✓	✓	✓	✓	✓
23	Timer 2 No. of Cycle/ON Delay/OFF Delay	✓	✓	✓	✓	✓	✓	✓	✓	✓	✓
24	Health Monitor Menu	✓	✓	✗	✗	✗	✓	✓	✗	✗	✗
25	Pre-paid Energy Menu	✓	✓	✓	✓	✓	✓	✓	✓	✓	✓
26	System Displacement Power Factor	✗	✗	✗	✗	✗	✓	✓	✓	✓	✓
27	System Reactive Power Factor	✗	✗	✗	✗	✗	✓	✓	✓	✓	✓
28	System LF Factor SgnQ(1-(P/S))	✗	✗	✗	✗	✗	✓	✓	✓	✓	✓
29	Old Sys Max Import/Export Watt Demand	✗	✗	✗	✗	✗	✓	✓	✓	✓	✓
30	Old Sys Max Capacitive/Inductive VAR Demand	✗	✗	✗	✗	✗	✓	✓	✓	✓	✓
31	Old Sys Max VA/A Demand	✗	✗	✗	✗	✗	✓	✓	✓	✓	✓

TABLE 1.1 System Parameters Screens Continued...

Parameter No.	Parameter	On Display					On Modbus				
		3P4W	3P3W	1P2W	1P3W	2P2W	3P4W	3P3W	1P2W	1P3W	2P2W
32	System Distortion VAR	X	X	X	X	X	✓	✓	✓	✓	✓
33	System Fundamental VAR	X	X	X	X	X	✓	✓	✓	✓	✓
34	System Max Reactive PF	X	X	X	X	X	✓	✓	✓	✓	✓
35	System Min Reactive PF	X	X	X	X	X	✓	✓	✓	✓	✓
36	System Max LF Factor SgnQ(1-(p/s))	X	X	X	X	X	✓	✓	✓	✓	✓
37	System Min LF Factor SgnQ(1-(p/s))	X	X	X	X	X	✓	✓	✓	✓	✓

NOTE : The Display screens of TABLE 1.1 can be scrolled through **Up Key**.

TABLE 1.2 Energy Parameters Screens :

Parameter No.	Parameters	On Display					On Modbus				
		3P 4W	3P 3W	1P 2W	1P 3W	2P 2W	3P 4W	3P 3W	1P 2W	1P 3W	2P 2W
1	System Active Energy Import(Overflow)	X	X	X	X	X	✓	✓	✓	✓	✓
2	System Active Energy Import	✓	✓	✓	✓	✓	✓	✓	✓	✓	✓
3	System Active Energy Export(Overflow)	X	X	X	X	X	✓	✓	✓	✓	✓
4	System Active Energy Export	✓	✓	✓	✓	✓	✓	✓	✓	✓	✓
5	System Reactive Capacitive energy (Overflow)	X	X	X	X	X	✓	✓	✓	✓	✓
6	System Reactive Capacitive energy	✓	✓	✓	✓	✓	✓	✓	✓	✓	✓
7	System Reactive Inductive energy (Overflow)	X	X	X	X	X	✓	✓	✓	✓	✓
8	System Reactive Inductive energy	✓	✓	✓	✓	✓	✓	✓	✓	✓	✓
9	System Apparent energy(Overflow)	X	X	X	X	X	✓	✓	✓	✓	✓
10	System Apparent energy	✓	✓	✓	✓	✓	✓	✓	✓	✓	✓
11	L1 Active Energy Import(Overflow)	X	X	X	X	X	✓	X	X	✓	X
12	L1 Active Energy Import	✓	X	X	✓	X	✓	X	X	✓	X
13	L1 Active Energy Export(Overflow)	X	X	X	X	X	✓	X	X	✓	X
14	L1 Active Energy Export	✓	X	X	✓	X	✓	X	X	✓	X
15	L1 Reactive Capacitive energy (Overflow)	X	X	X	X	X	✓	X	X	✓	X
16	L1 Reactive Capacitive energy	✓	X	X	✓	X	✓	X	X	✓	X
17	L1 Reactive Inductive energy (Overflow)	X	X	X	X	X	✓	X	X	✓	X
18	L1 Reactive Inductive energy	✓	X	X	✓	X	✓	X	X	✓	X
19	L1 Apparent energy(Overflow)	X	X	X	X	X	✓	X	X	✓	X
20	L1 Apparent energy	✓	X	X	✓	X	✓	X	X	✓	X

Table 1.2 Energy Parameters Screens Continued...

Parameter No.	Parameters	On Display					On Modbus				
		3P 4W	3P 3W	1P 2W	1P 3W	2P 2W	3P 4W	3P 3W	1P 2W	1P 3W	2P 2W
21	L2 Active Energy Import(Overflow)	✗	✗	✗	✗	✗	✓	✗	✗	✓	✗
22	L2 Active Energy Import	✓	✗	✗	✓	✗	✓	✗	✗	✓	✗
23	L2 Active Energy Export(Overflow)	✗	✗	✗	✗	✗	✓	✗	✗	✓	✗
24	L2 Active Energy Export	✓	✗	✗	✓	✗	✓	✗	✗	✓	✗
25	L2 Reactive Capacitive energy (Overflow)	✗	✗	✗	✗	✗	✓	✗	✗	✓	✗
26	L2 Reactive Capacitive energy	✓	✗	✗	✓	✗	✓	✗	✗	✓	✗
27	L2 Reactive Inductive energy (Overflow)	✗	✗	✗	✗	✗	✓	✗	✗	✓	✗
28	L2 Reactive Inductive energy	✓	✗	✗	✓	✗	✓	✗	✗	✓	✗
29	L2 Apparent energy(Overflow)	✗	✗	✗	✗	✗	✓	✗	✗	✓	✗
30	L2 Apparent energy	✓	✗	✗	✓	✗	✓	✗	✗	✓	✗
31	L3 Active Energy Import(Overflow)	✗	✗	✗	✗	✗	✓	✗	✗	✗	✗
32	L3 Active Energy Import	✓	✗	✗	✗	✗	✓	✗	✗	✗	✗
33	L3 Active Energy Export(Overflow)	✗	✗	✗	✗	✗	✓	✗	✗	✗	✗
34	L3 Active Energy Export	✓	✗	✗	✗	✗	✓	✗	✗	✗	✗
35	L3 Reactive Capacitive energy (Overflow)	✗	✗	✗	✗	✗	✓	✗	✗	✗	✗
36	L3 Reactive Capacitive energy	✓	✗	✗	✗	✗	✓	✗	✗	✗	✗
37	L3 Reactive Inductive energy (Overflow)	✗	✗	✗	✗	✗	✓	✗	✗	✗	✗
38	L3 Reactive Inductive energy	✓	✗	✗	✗	✗	✓	✗	✗	✗	✗
39	L3 Apparent energy(Overflow)	✗	✗	✗	✗	✗	✓	✗	✗	✗	✗
40	L3 Apparent energy	✓	✗	✗	✗	✗	✓	✗	✗	✗	✗
41	L1 Total Active Energy Overflow Count	✗	✗	✗	✗	✗	✓	✗	✗	✗	✗
42	L1 Total Active Energy	✓	✗	✗	✓	✗	✓	✗	✗	✓	✗
43	L1 Total Reactive Energy Overflow Count	✗	✗	✗	✗	✗	✓	✗	✗	✗	✗
44	L1 Total Reactive Energy	✓	✗	✗	✓	✗	✓	✗	✗	✓	✗
45	L2 Total Active Energy Overflow Count	✗	✗	✗	✗	✗	✓	✗	✗	✗	✗
46	L2 Total Active Energy	✓	✗	✗	✓	✗	✓	✗	✗	✓	✗
47	L2 Total Reactive Energy Overflow Count	✗	✗	✗	✗	✗	✓	✗	✗	✗	✗
48	L2 Total Reactive Energy	✓	✗	✗	✓	✗	✓	✗	✗	✓	✗
49	L3 Total Active Energy Overflow Count	✗	✗	✗	✗	✗	✓	✗	✗	✗	✗
50	L3 Total Active Energy	✓	✗	✗	✗	✗	✓	✗	✗	✗	✗
51	L3 Total Reactive Energy Overflow Count	✗	✗	✗	✗	✗	✓	✗	✗	✗	✗
52	L3 Total Reactive Energy	✓	✗	✗	✗	✗	✓	✗	✗	✗	✗
53	Sys Total Active Energy Overflow Count	✗	✗	✗	✗	✗	✓	✓	✓	✓	✓
54	Sys Total Active Energy	✓	✓	✓	✓	✓	✓	✓	✓	✓	✓

Table 1.2 Energy Parameters Screens Continued...

Parameter No.	Parameters	On Display					On Modbus				
		3P 4W	3P 3W	1P 2W	1P 3W	2P 2W	3P 4W	3P 3W	1P 2W	1P 3W	2P 2W
55	Sys Total Reactive Energy Overflow Count	✗	✗	✗	✗	✗	✓	✓	✓	✓	✓
56	Sys Total Reactive Energy	✓	✓	✓	✓	✓	✓	✓	✓	✓	✓
57	System Import Inductive (Q1) VAh Overflow Count	✗	✗	✗	✗	✗	✓	✓	✓	✓	✓
58	System Import Inductive (Q1) VAh	✓	✓	✓	✓	✓	✓	✓	✓	✓	✓
59	System Export Inductive (Q3) VAh Overflow Count	✗	✗	✗	✗	✗	✓	✓	✓	✓	✓
60	System Export Inductive (Q3) VAh	✓	✓	✓	✓	✓	✓	✓	✓	✓	✓
61	System Import Capacitive (Q2) VAh Overflow Count	✗	✗	✗	✗	✗	✓	✓	✓	✓	✓
62	System Import Capacitive (Q2) VAh	✓	✓	✓	✓	✓	✓	✓	✓	✓	✓
63	System Export Capacitive (Q4) VAh Overflow Count	✗	✗	✗	✗	✗	✓	✓	✓	✓	✓
64	System Export Capacitive (Q4) VAh	✓	✓	✓	✓	✓	✓	✓	✓	✓	✓
65	L1 Import Inductive (Q1) VAh Overflow Count	✗	✗	✗	✗	✗	✓	✗	✗	✓	✗
66	L1 Import Inductive (Q1) VAh	✓	✗	✗	✓	✗	✓	✗	✗	✓	✗
67	L1 Export Inductive (Q3) VAh Overflow Count	✗	✗	✗	✗	✗	✓	✗	✗	✓	✗
68	L1 Export Inductive (Q3) VAh	✓	✗	✗	✓	✗	✓	✗	✗	✓	✗
69	L1 Import Capacitive (Q2) VAh Overflow Count	✗	✗	✗	✗	✗	✓	✗	✗	✓	✗
70	L1 Import Capacitive (Q2) VAh	✓	✗	✗	✓	✗	✓	✗	✗	✓	✗
71	L1 Export Capacitive (Q4) VAh Overflow Count	✗	✗	✗	✗	✗	✓	✗	✗	✓	✗
72	L1 Export Capacitive (Q4) VAh	✓	✗	✗	✓	✗	✓	✗	✗	✓	✗
73	L2 Import Inductive (Q1) VAh Overflow Count	✗	✗	✗	✗	✗	✓	✗	✗	✓	✗
74	L2 Import Inductive (Q1) VAh	✓	✗	✗	✓	✗	✓	✗	✗	✓	✗
75	L2 Export Inductive (Q3) VAh Overflow Count	✗	✗	✗	✗	✗	✓	✗	✗	✓	✗
76	L2 Export Inductive (Q3) VAh	✓	✗	✗	✓	✗	✓	✗	✗	✓	✗
77	L2 Import Capacitive (Q2) VAh Overflow Count	✗	✗	✗	✗	✗	✓	✗	✗	✓	✗
78	L2 Import Capacitive (Q2) VAh	✓	✗	✗	✓	✗	✓	✗	✗	✓	✗
79	L2 Export Capacitive (Q4) VAh Overflow Count	✗	✗	✗	✗	✗	✓	✗	✗	✓	✗
80	L2 Export Capacitive (Q4) VAh	✓	✗	✗	✓	✗	✓	✗	✗	✓	✗
81	L3 Import Inductive (Q1) VAh Overflow Count	✗	✗	✗	✗	✗	✓	✗	✗	✓	✗
82	L3 Import Inductive (Q1) VAh	✓	✗	✗	✗	✗	✓	✗	✗	✓	✗
83	L3 Export Inductive (Q3) VAh Overflow Count	✗	✗	✗	✗	✗	✓	✗	✗	✓	✗
84	L3 Export Inductive (Q3) VAh	✓	✗	✗	✗	✗	✓	✗	✗	✓	✗
85	L3 Import Capacitive (Q2) VAh Overflow Count	✗	✗	✗	✗	✗	✓	✗	✗	✓	✗
86	L3 Import Capacitive (Q2) VAh	✓	✗	✗	✗	✗	✓	✗	✗	✓	✗
87	L3 Export Capacitive (Q4) VAh Overflow Count	✗	✗	✗	✗	✗	✓	✗	✗	✓	✗
88	L3 Export Capacitive (Q4) VAh	✓	✗	✗	✗	✗	✓	✗	✗	✓	✗

Table 1.2 Energy Parameters Screens Continued...

Parameter No.	Parameters	On Display					On Modbus				
		3P 4W	3P 3W	1P 2W	1P 3W	2P 2W	3P 4W	3P 3W	1P 2W	1P 3W	2P 2W
89	System Total Import (Q1 + Q2) Varh Overflow Count	✗	✗	✗	✗	✗	✓	✓	✓	✓	✓
90	System Total Import (Q1 + Q2) VAh	✓	✓	✓	✓	✓	✓	✓	✓	✓	✓
91	System Total Export (Q3 + Q4) Varh Overflow Count	✗	✗	✗	✗	✗	✓	✓	✓	✓	✓
92	System Total Export (Q3 + Q4) VAh	✓	✓	✓	✓	✓	✓	✓	✓	✓	✓
93	System Total Inductive (Q1 + Q3) Varh Overflow Count	✗	✗	✗	✗	✗	✓	✓	✓	✓	✓
94	System Total Inductive (Q1 + Q3) VAh	✓	✓	✓	✓	✓	✓	✓	✓	✓	✓
95	System Total Capacitive (Q2 + Q4) Varh Overflow Count	✗	✗	✗	✗	✗	✓	✓	✓	✓	✓
96	System Total Capacitive (Q2 + Q4) VAh	✓	✓	✓	✓	✓	✓	✓	✓	✓	✓
97	L1 Total Import (Q1 + Q2) Varh Overflow Count	✗	✗	✗	✗	✗	✓	✗	✗	✓	✗
98	L1 Total Import (Q1 + Q2) VAh	✓	✗	✗	✓	✗	✓	✗	✗	✓	✗
99	L1 Total Export (Q3 + Q4) Varh Overflow Count	✗	✗	✗	✗	✗	✓	✗	✗	✓	✗
100	L1 Total Export (Q3 + Q4) VAh	✓	✗	✗	✓	✗	✓	✗	✗	✓	✗
101	L1 Total Inductive (Q1 + Q3) Varh Overflow Count	✗	✗	✗	✗	✗	✓	✗	✗	✓	✗
102	L1 Total Inductive (Q1 + Q3) VAh	✓	✗	✗	✓	✗	✓	✗	✗	✓	✗
103	L1 Total Capacitive (Q2 + Q4) Varh Overflow Count	✗	✗	✗	✗	✗	✓	✗	✗	✓	✗
104	L1 Total Capacitive (Q2 + Q4) VAh	✓	✗	✗	✓	✗	✓	✗	✗	✓	✗
105	L2 Total Import (Q1 + Q2) Varh Overflow Count	✗	✗	✗	✗	✗	✓	✗	✗	✓	✗
106	L2 Total Import (Q1 + Q2) VAh	✓	✗	✗	✓	✗	✓	✗	✗	✓	✗
107	L2 Total Export (Q3 + Q4) Varh Overflow Count	✗	✗	✗	✗	✗	✓	✗	✗	✓	✗
108	L2 Total Export (Q3 + Q4) VAh	✓	✗	✗	✓	✗	✓	✗	✗	✓	✗
109	L2 Total Inductive (Q1 + Q3) Varh Overflow Count	✗	✗	✗	✗	✗	✓	✗	✗	✓	✗
110	L2 Total Inductive (Q1 + Q3) VAh	✓	✗	✗	✓	✗	✓	✗	✗	✓	✗
111	L2 Total Capacitive (Q2 + Q4) Varh Overflow Count	✗	✗	✗	✗	✗	✓	✗	✗	✓	✗
112	L2 Total Capacitive (Q2 + Q4) VAh	✓	✗	✗	✓	✗	✓	✗	✗	✓	✗
113	L3 Total Import (Q1 + Q2) Varh Overflow Count	✗	✗	✗	✗	✗	✓	✗	✗	✗	✗
114	L3 Total Import (Q1 + Q2) VAh	✓	✗	✗	✗	✗	✓	✗	✗	✗	✗
115	L3 Total Export (Q3 + Q4) Varh Overflow Count	✗	✗	✗	✗	✗	✓	✗	✗	✗	✗
116	L3 Total Export (Q3 + Q4) VAh	✓	✗	✗	✗	✗	✓	✗	✗	✗	✗
117	L3 Total Inductive (Q1 + Q3) Varh Overflow Count	✗	✗	✗	✗	✗	✓	✗	✗	✗	✗
118	L3 Total Inductive (Q1 + Q3) VAh	✓	✗	✗	✗	✗	✓	✗	✗	✗	✗
119	L3 Total Capacitive (Q2 + Q4) Varh Overflow Count	✗	✗	✗	✗	✗	✓	✗	✗	✗	✗
120	L3 Total Capacitive (Q2 + Q4) VAh	✓	✗	✗	✗	✗	✓	✗	✗	✗	✗
121	System Net Total Wh Overflow Count	✗	✗	✗	✗	✗	✓	✓	✓	✓	✓
122	System Net Total Wh	✓	✓	✓	✓	✓	✓	✓	✓	✓	✓

Table 1.2 Energy Parameters Screens Continued...

Parameter No.	Parameters	On Display					On Modbus				
		3P 4W	3P 3W	1P 2W	1P 3W	2P 2W	3P 4W	3P 3W	1P 2W	1P 3W	2P 2W
123	System Apparent while Active Import Vah Overflow Count	✗	✗	✗	✗	✗	✓	✓	✓	✓	✓
124	System Apparent while Active Import Vah	✓	✓	✓	✓	✓	✓	✓	✓	✓	
125	System Apparent while Active Export Vah Overflow Count	✗	✗	✗	✗	✗	✓	✓	✓	✓	
126	System Apparent while Active Export Vah	✓	✓	✓	✓	✓	✓	✓	✓	✓	
127	Run hour	✓	✓	✓	✓	✓	✓	✓	✓	✓	
128	On hour	✓	✓	✓	✓	✓	✓	✓	✓	✓	
129	No. of interrupts	✓	✓	✓	✓	✓	✓	✓	✓	✓	
130	Tariff 1 Energy 1	✓	✓	✓	✓	✓	✓	✓	✓	✓	
131	Tariff 1 Energy 2	✓	✓	✓	✓	✓	✓	✓	✓	✓	
132	Tariff 1 Energy 3	✓	✓	✓	✓	✓	✓	✓	✓	✓	
133	Tariff 1 Energy 4	✓	✓	✓	✓	✓	✓	✓	✓	✓	
134	Tariff 1 Energy 5	✓	✓	✓	✓	✓	✓	✓	✓	✓	
135	Tariff 1 Energy 6	✓	✓	✓	✓	✓	✓	✓	✓	✓	
136	Tariff 2 Energy 1	✓	✓	✓	✓	✓	✓	✓	✓	✓	
137	Tariff 2 Energy 2	✓	✓	✓	✓	✓	✓	✓	✓	✓	
138	Tariff 2 Energy 3	✓	✓	✓	✓	✓	✓	✓	✓	✓	
139	Tariff 2 Energy 4	✓	✓	✓	✓	✓	✓	✓	✓	✓	
140	Tariff 2 Energy 5	✓	✓	✓	✓	✓	✓	✓	✓	✓	
151	Tariff 2 Energy 6	✓	✓	✓	✓	✓	✓	✓	✓	✓	
152	Old Energy Unit	✓	✓	✓	✓	✓	✓	✓	✓	✓	
153	Old System Active Energy Import(Overflow)	✗	✗	✗	✗	✗	✓	✓	✓	✓	
154	Old System Active Energy Import	✗	✗	✗	✗	✗	✓	✓	✓	✓	
155	Old System Active Energy Export(Overflow)	✗	✗	✗	✗	✗	✓	✓	✓	✓	
156	Old System Active Energy Export	✗	✗	✗	✗	✗	✓	✓	✓	✓	
157	Old System Reactive Capacitive energy (Overflow)	✗	✗	✗	✗	✗	✓	✓	✓	✓	
158	Old System Reactive Capacitive energy	✗	✗	✗	✗	✗	✓	✓	✓	✓	
159	Old System Reactive Inductive energy (Overflow)	✗	✗	✗	✗	✗	✓	✓	✓	✓	
160	Old System Reactive Inductive energy	✗	✗	✗	✗	✗	✓	✓	✓	✓	
161	Old System Apparent energy(Overflow)	✗	✗	✗	✗	✗	✓	✓	✓	✓	
162	Old System Apparent energy	✗	✗	✗	✗	✗	✓	✓	✓	✓	
163	Old L1 Active Energy Import(Overflow)	✗	✗	✗	✗	✗	✓	✗	✗	✗	
164	Old L1 Active Energy Import	✗	✗	✗	✗	✗	✓	✗	✗	✗	
165	Old L1 Active Energy Export(Overflow)	✗	✗	✗	✗	✗	✓	✗	✗	✗	
166	Old L1 Active Energy Export	✗	✗	✗	✗	✗	✓	✗	✗	✗	

Table 1.2 Energy Parameters Screens Continued...

Parameter No.	Parameters	On Display					On Modbus				
		3P 4W	3P 3W	1P 2W	1P 3W	2P 2W	3P 4W	3P 3W	1P 2W	1P 3W	2P 2W
167	Old L1 Reactive Capacitive energy (Overflow)	x	x	x	x	x	✓	x	x	x	x
168	Old L1 Reactive Capacitive energy	x	x	x	x	x	✓	x	x	x	x
169	Old L1 Reactive Inductive energy (Overflow)	x	x	x	x	x	✓	x	x	x	x
170	Old L1 Reactive Inductive energy	x	x	x	x	x	✓	x	x	x	x
171	Old L1 Apparent energy(Overflow)	x	x	x	x	x	✓	x	x	x	x
172	Old L1 Apparent energy	x	x	x	x	x	✓	x	x	x	x
173	Old L2 Active Energy Import(Overflow)	x	x	x	x	x	✓	x	x	x	x
174	Old L2 Active Energy Import	x	x	x	x	x	✓	x	x	x	x
175	Old L2 Active Energy Export(Overflow)	x	x	x	x	x	✓	x	x	x	x
176	Old L2 Active Energy Export	x	x	x	x	x	✓	x	x	x	x
177	Old L2 Reactive Capacitive energy (Overflow)	x	x	x	x	x	✓	x	x	x	x
178	Old L2 Reactive Capacitive energy	x	x	x	x	x	✓	x	x	x	x
179	Old L2 Reactive Inductive energy (Overflow)	x	x	x	x	x	✓	x	x	x	x
180	Old L2 Reactive Inductive energy	x	x	x	x	x	✓	x	x	x	x
181	Old L2 Apparent energy(Overflow)	x	x	x	x	x	✓	x	x	x	x
182	Old L2 Apparent energy	x	x	x	x	x	✓	x	x	x	x
183	Old L3 Active Energy Import(Overflow)	x	x	x	x	x	✓	x	x	x	x
184	Old L3 Active Energy Import	x	x	x	x	x	✓	x	x	x	x
185	Old L3 Active Energy Export(Overflow)	x	x	x	x	x	✓	x	x	x	x
186	Old L3 Active Energy Export	x	x	x	x	x	✓	x	x	x	x
187	Old L3 Reactive Capacitive energy (Overflow)	x	x	x	x	x	✓	x	x	x	x
188	Old L3 Reactive Capacitive energy	x	x	x	x	x	✓	x	x	x	x
189	Old L3 Reactive Inductive energy (Overflow)	x	x	x	x	x	✓	x	x	x	x
190	Old L3 Reactive Inductive energy	x	x	x	x	x	✓	x	x	x	x
191	Old L3 Apparent energy(Overflow)	x	x	x	x	x	✓	x	x	x	x
192	Old L3 Apparent energy	x	x	x	x	x	✓	x	x	x	x
193	Old Sys Total Active Energy Overflow Count	x	x	x	x	x	✓	✓	✓	✓	✓
194	Old Sys Total Active Energy	x	x	x	x	x	✓	✓	✓	✓	✓
195	Old Sys Total Reactive Energy Overflow Count	x	x	x	x	x	✓	✓	✓	✓	✓
196	Old Sys Total Reactive Energy	x	x	x	x	x	✓	✓	✓	✓	✓
197	Old L1 Total Active Energy Overflow Count	x	x	x	x	x	✓	x	x	x	x
198	Old L1 Total Active Energy	x	x	x	x	x	✓	x	x	x	x
199	Old L1 Total Reactive Energy Overflow Count	x	x	x	x	x	✓	x	x	x	x
200	Old L1 Total Reactive Energy	x	x	x	x	x	✓	x	x	x	x

Table 1.2 Energy Parameters Screens Continued...

Parameter No.	Parameters	On Display					On Modbus				
		3P 4W	3P 3W	1P 2W	1P 3W	2P 2W	3P 4W	3P 3W	1P 2W	1P 3W	2P 2W
201	Old L2 Total Active Energy Overflow Count	✗	✗	✗	✗	✗	✓	✗	✗	✗	✗
202	Old L2 Total Active Energy	✗	✗	✗	✗	✗	✓	✗	✗	✗	✗
203	Old L2 Total Reactive Energy Overflow Count	✗	✗	✗	✗	✗	✓	✗	✗	✗	✗
204	Old L2 Total Reactive Energy	✗	✗	✗	✗	✗	✓	✗	✗	✗	✗
205	Old L3 Total Active Energy Overflow Count	✗	✗	✗	✗	✗	✓	✗	✗	✗	✗
206	Old L3 Total Active Energy	✗	✗	✗	✗	✗	✓	✗	✗	✗	✗
207	Old L3 Total Reactive Energy Overflow Count	✗	✗	✗	✗	✗	✓	✗	✗	✗	✗
208	Old L3 Total Reactive Energy	✗	✗	✗	✗	✗	✓	✗	✗	✗	✗
209	Old Run Hour	✗	✗	✗	✗	✗	✓	✓	✓	✓	✓
210	Old On Hour	✗	✗	✗	✗	✗	✓	✓	✓	✓	✓
211	Old no. of interrupts	✗	✗	✗	✗	✗	✓	✓	✓	✓	✓
212	Digital Input 1 Pulse Counter	✗	✗	✗	✗	✗	✓	✓	✓	✓	✓
213	Digital Input 2 Pulse Counter	✗	✗	✗	✗	✗	✓	✓	✓	✓	✓
214	Digital Input 1 Pulse Counter Overflow Count	✗	✗	✗	✗	✗	✓	✓	✓	✓	✓
215	Digital Input 2 Pulse Counter Overflow Count	✗	✗	✗	✗	✗	✓	✓	✓	✓	✓

NOTE : 1) The Display screens of Table 1.2 can be scrolled through **Enter Key**.

2) Energy on Display is Auto-Ranging For details refer Section 4.1.

TABLE 1.3 Power Parameters Screens :

Parameter No.	Parameters	On Display					On Modbus				
		3P4W	3P3W	1P2W	1P3W	2P2W	3P4W	3P3W	1P2W	1P3W	2P2W
1	L1 VA-VAr-Watt-Power Factor	✓	✗	✗	✓	✗	✓	✗	✗	✓	✗
2	L2 VA-VAr-Watt-Power Factor	✓	✗	✗	✓	✗	✓	✗	✗	✓	✗
3	L3 VA-VAr-Watt-Power Factor	✓	✗	✗	✗	✗	✓	✗	✗	✗	✗
4	L1-L2-L3 Degree	✓	✗	✗	✓	✗	✓	✗	✗	✓	✗
5	System VA-VAr-Watt-Power Factor	✓	✓	✓	✓	✓	✓	✓	✓	✓	✓
6	L1 Max VA-VAr-Watt-Power Factor	✓	✗	✗	✓	✗	✓	✗	✗	✓	✗
7	L1 Min VA-VAr-Watt-Power Factor	✓	✗	✗	✓	✗	✓	✗	✗	✓	✗
8	L2 Max VA-VAr-Watt-Power Factor	✓	✗	✗	✓	✗	✓	✗	✗	✓	✗
9	L2 Min VA-VAr-Watt-Power Factor	✓	✗	✗	✓	✗	✓	✗	✗	✓	✗
10	L3 Max VA-VAr-Watt-Power Factor	✓	✗	✗	✗	✗	✓	✗	✗	✗	✗
11	L3 Min VA-VAr-Watt-Power Factor	✓	✗	✗	✗	✗	✓	✗	✗	✗	✗
12	L1-L2-L3 Max Degree	✓	✗	✗	✓	✗	✓	✗	✗	✓	✗
13	L1-L2-L3 Min Degree	✓	✗	✗	✓	✗	✓	✗	✗	✓	✗
14	L1-L2-L3 Displacement Power Factor*	✓	✗	✗	✓	✗	✓	✗	✗	✓	✗
15	System Displacement PF	✓	✓	✓	✓	✓	✓	✓	✓	✓	✓
16	L1-L2-L3 Max Reactive Power Factor*	✗	✗	✗	✗	✗	✓	✗	✗	✓	✗
17	L1-L2-L3 Min Reactive Power Factor*	✗	✗	✗	✗	✗	✓	✗	✗	✓	✗
18	L1-L2-L3 Max LF Factor SgnQ(1-(P/S))*	✗	✗	✗	✗	✗	✓	✗	✗	✓	✗
19	L1-L2-L3 Min LF Factor SgnQ(1-(P/S))*	✗	✗	✗	✗	✗	✓	✗	✗	✓	✗

NOTE : The Display screens of TABLE 1.3 can be scrolled through P/Down Key.

NOTE* : Parameter marked with **: In 1P3W, L3 is not valid.

TABLE 1.4 Voltage/Current Parameters Screens :

Para-meter No.	Parameter	On Display					On Modbus				
		3P4W	3P3W	1P2W	1P3W	2P2W	3P4W	3P3W	1P2W	1P3W	2P2W
1	L1-L2-L3- Avg System Voltage*	✓	✗	✗	✓	✗	✓	✗	✗	✓	✗
2	L12-L23-L31 Voltage**	✓	✓	✗	✓	✗	✓	✓	✗	✓	✗
3	L1-L2-L3 Current*	✓	✓	✗	✓	✗	✓	✓	✗	✓	✗
3	Neutral Current	✓	✗	✗	✓	✗	✓	✗	✗	✓	✗
4	L1-L2-L3 Voltage % THD*	✓	✓	✗	✓	✗	✓	✓	✗	✓	✗
5	L1-L2-L3 Current % THD*	✓	✓	✗	✓	✗	✓	✓	✗	✓	✗
6	Current Reversal	✓	✗	✗	✓	✗	✗	✗	✗	✗	✗
7	Phase Rotation Error	✓	✓	✗	✗	✗	✓	✓	✗	✗	✗
8	Phase Absent Indication	✓	✓	✗	✗	✗	✗	✗	✗	✗	✗
9	System Voltage-Current-Active Power-Frequency	✓	✓	✓	✓	✓	✓	✓	✓	✓	✓
10	L1-L2-L3 Average Max Voltage*	✓	✗	✗	✓	✗	✓	✗	✗	✓	✗
11	L1-L2-L3 Average Min Voltage*	✓	✗	✗	✓	✗	✓	✗	✗	✓	✗
12	L12-L23-L31 Max Voltage**	✓	✓	✗	✓	✗	✓	✓	✗	✓	✗
13	L12-L23-L31 Min Voltage**	✓	✓	✗	✓	✗	✓	✓	✗	✓	✗
14	L1-L2-L3 Max Current*	✓	✓	✗	✓	✗	✓	✓	✗	✓	✗
15	L1-L2-L3 Min Current*	✓	✓	✗	✓	✗	✓	✓	✗	✓	✗
16	%Voltage(L-N) unbalance, %Current unbalance	✓	✓	✗	✗	✗	✓	✓	✗	✗	✗
17	Individual Harmonics V(upto 31st)	✓	✓	✓	✓	✓	✓	✓	✓	✓	✓
18	Individual Harmonics A(upto 31st)	✓	✓	✓	✓	✓	✓	✓	✓	✓	✓

NOTE : The Display screens of TABLE 1.4 can be scrolled through V/A Key.

NOTE* : Parameter with ** marked: In 1P3W, L3 is not valid.

NOTE :** Parameter with *** marked: In 1P3W, L23 & L31 is not valid.

2.1 Current Reversal Screen

This screen is one of the Voltage / Current Parameter Screens and is useful to indicate if current in any phase is reversed or not. If current in any phase gets reversed, then corresponding phase will be indicated on this screen.

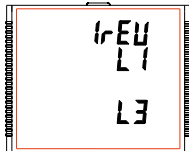

This screen shows that currents in L1 and L3 are reversed.

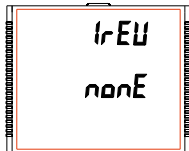

This screen shows that currents in all three phase are correct.

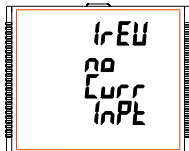

This screen shows that the meter has no current input.

2.2 Phase Rotation Error Screen

This screen is one of the Voltage / Current Parameter Screens and shows phase rotation information for the phase sequence R-Y-B (L1-L2-L3).

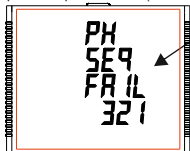

This screen indicates that Phase Sequence is incorrect.

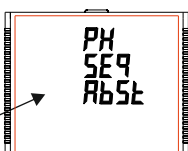

This screen indicates that all three phases (voltages) are absent.

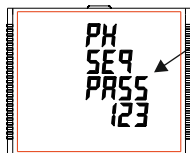

This screen indicates that Phase Sequence is correct.

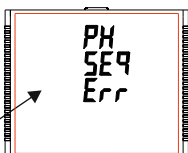

This screen indicates that either one or two of the three phases (voltages) are absent.

User must check this screen in order to get correct readings when meter is connected.

2.3 Phase Absent Screen

This screen is one of the Voltage / Current Parameter Screens and is useful to indicate if voltage or current in any phase is absent. Hence, user will know which voltage or current is missing and take corrective action.

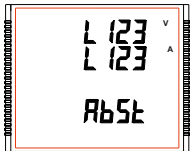

This screen indicates that all three phases (V & I) are absent.

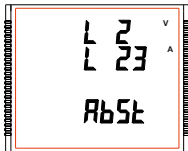

This screen indicates that V2, I2 and I3 are absent.



This screen indicates that all three phases are present i.e. all inputs are present.

2.4 % Voltage Unbalanced and % Current Unbalanced Screen

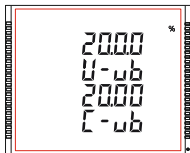

This screen is one of the Voltage / Current Parameter screens and is useful to display the percentage unbalanced in both voltage and current across three phase system.

Here, %Voltage unbalanced (V-ub) indicates the deviation in phase voltages from their average value. and %Current unbalanced(C-ub) indicates the deviation in phases currents from their average value.

2.5 Individual Harmonics



This screen is one of the Voltage/Current parameter screen. The **Individual Harmonics** can be accessed by pressing the Enter key followed by the Up and Down keys taking through the 63 harmonics.



Similarly, pressing the Enter(E) key at the quit screen takes the user out of the Individual Harmonics Screen.

2.6 Load Health Monitor Screen



The **Load Health Monitor Menu** is one of the System Parameter Screens and shows the health status of the three phase load. The faults can be monitored by pressing the Enter Key followed by the Up and Down keys taking through all the different errors (if any) of the Three Phase load. Types of Error shown :

- 1) Phase Fail
- 2) Unbalanced Voltage
- 3) Unbalanced Current
- 4) Phase Reversal
- 5) Under Frequency
- 6) Under Voltage
- 7) Over Current
- 8) Over Voltage

2.6.1. Health Monitor Fault Screens

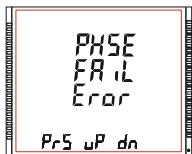

This screen indicates that phase fail fault is present.



This screen indicates that voltage unbalanced fault is present.



This screen indicates that current unbalanced fault is present.

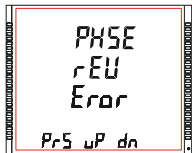

This screen indicates that phase reverse fault is present.

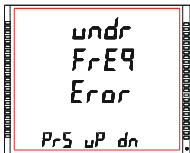

This screen indicates that under frequency fault is present.

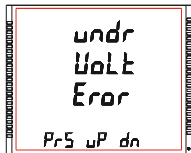

This screen indicates that under voltage fault is present.

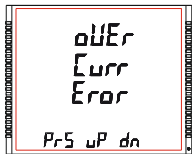

This screen indicates that over current fault is present.



This screen indicates that over voltage fault is present.

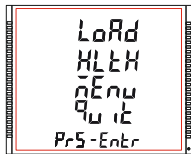

By pressing the  key at the **quit screen** takes the user out of the Load Health Monitor Menu Screen.

2.7 Quadrant wise Reactive Energy Measurement Screens

This screen is one of the Energy Parameter Screen. This screen shows energies quadrant wise i.e, Q1, Q2, Q3 & Q4 for system and per phase.

Quadrant wise reactive energy measurement has two menus :-

1. Individual quadrant wise reactive energy measurement (Q1, Q2, Q3 and Q4)
2. Sum quadrant wise reactive energy measurement (Q1+Q2, Q3+Q4, Q1+Q3 and Q2+Q4)

2.7.1 First menu of quadrant wise reactive energy measurement screens

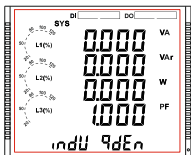

This screen is the first screen of the Individual quadrant wise reactive energy measurement of first menu. This screen will toggle in 3 different screens "Individual Quadrant Energy", "Long Press" and "To Enter" screens.

For entering in quadrant wise reactive energy menu, long press " ← " key.

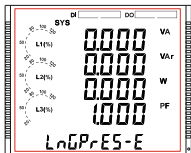

This screen is the second screen of the Individual quadrant wise reactive energy measurement menu.

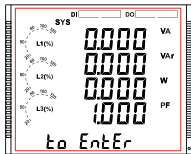

This screen is the third screen of the Individual quadrant wise reactive energy measurement menu.

Reading Screen

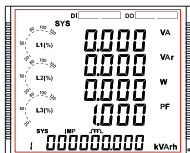

This screen is the first screen of the Individual quadrant wise reactive energy measurement. This screen shows "System Import Inductive reactive energy" and "1" shows first quadrant (Q1) energy displayed on the screen.

Press " \leftarrow " key advanced to the next quadrant screen.

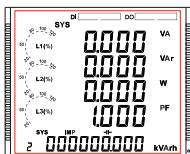

This screen shows "System Import Capacitive reactive energy" and "2" shows second quadrant (Q2) energy displayed on the screen.

Press " \leftarrow " key advanced to the next quadrant screen.

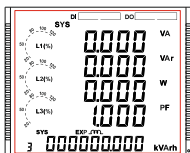

This screen shows "System Export Inductive reactive energy" and "3" shows third quadrant (Q3) energy displayed on the screen.

Press " \leftarrow " key advanced to the next quadrant screen.

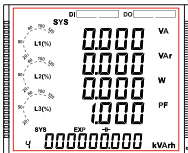

This screen shows "System Export Capacitive reactive energy" and "4" shows fourth quadrant (Q4) energy displayed on the screen.

Press "←" key advanced to the next quadrant screen.

2.7.2 Second menu of Quadrant wise reactive energy measurement screen

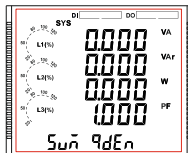

This screen is the first screen of the Sum quadrant wise reactive energy measurement of second menu. This screen will also toggle in 3 different screens "Sum Quadrant Energy", "Long Press" and "To Enter" screens.

For entering in quadrant wise reactive energy screens, long press "←" key.

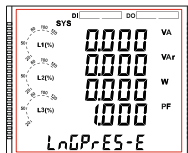

This screen is the second screen of the Sum quadrant wise reactive energy measurement menu.

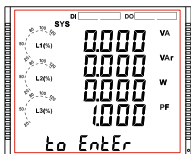

This screen is the third screen of the Sum quadrant wise reactive energy measurement menu.

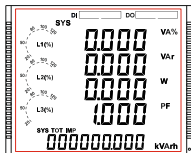

This screen is the first screen of the Sum quadrant wise reactive energy measurement. This screen shows "System Total Import reactive energy" (Q1+Q2).

Press "←" key advanced to the next quadrant screen.

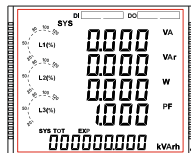

This screen shows "System Total Export reactive Energy" (Q3+Q4).

Press "←" key advanced to the next quadrant screen.

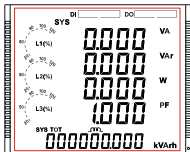

This screen shows "System Total Inductive reactive energy" (Q1+Q3).

Press "←" key advanced to the next quadrant screen.

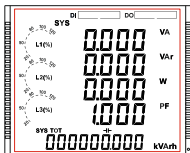

This screen shows "System Total Capacitive reactive energy" (Q2+Q4).

Press "←" key advanced to the next quadrant screen.

2.8 System Net Active Total Energy

This screen is one of the Energy Parameter Screen. This screen shows system active total energy.

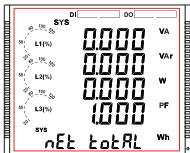

This screen toggles between "nEt totAL" and value reading screen.

1. Net active total energy = Import active energy - Export active energy or
 2. Net active total energy = Export active energy - Import active energy
- According to the definition refer section (3.2.1.16)

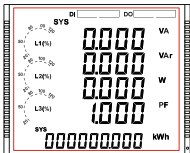

This screen shows System net active total energy measurement.

According to the definition refer section (3.2.1.16), if net active total energy is set to " 0 " then first formula (refer section 2.8) will applicable and if import is greater then export then this screen appear.

Also, if net active total energy is set to " 1 " then second formula (refer section 2.8) will applicable and if export is greater then import then this screen appear.

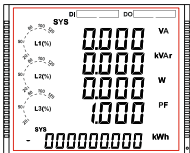

This screen shows System net total active energy measurement with " - " sign.

According to the definition refer section (3.2.1.16), if net active total energy is set to " 0 " then first formula (refer section 2.8) will applicable and if export is greater then import then this screen appear.

Also, if net active total energy is set to " 1 " then second formula (refer section 2.8) will applicable and if import is greater then export then this screen appear.

2.9 Apparent Energy while active Import / Export

2.9.1 Apparent Energy while active Import

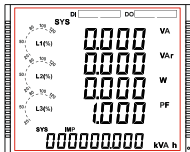

This screen displays only apparent energy while active import. If system active import kWh is increasing only then this screen counters will increase.

Pressing " ← " key advances user to next screen which is system Export reactive screen.

2.9.2 Apparent Energy while active Export

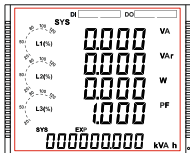

This screen displays only apparent energy while active export. If system active export kWh is increasing only then this screen counters will increase.

Pressing " ← " key advances user to system Import reactive Screen.

2.10 Pre Paid Energy Menu

This screen is one of the System Parameter Screens.



Pre Paid Menu shows Balance energy & Balance cost for the energy selected and can be accessed by pressing the Enter Key.

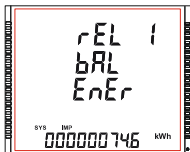

This Screen shows Balance energy of the parameter selected in the relay 1 output pre-paid Energy mode.



This Screen shows the Balance cost of the parameter selected in the relay 1 output pre-paid Energy mode.

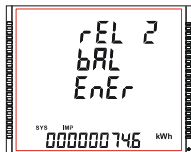

This Screen shows Balance energy of the parameter selected in the relay 2 output pre-paid Energy mode.



This Screen shows the Balance cost of the parameter selected in the relay 2 output pre-paid Energy mode.

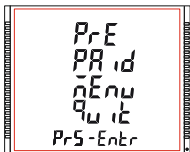

Pressing the " ← " key at the quit screen takes the user out of the Pre Paid Menu Screen.

2.11 Timer 1 & Timer 2 Screens

This screen is one of the System Parameter Screens.

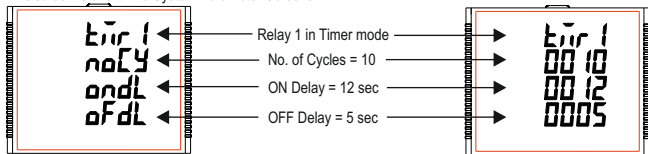

The screen shows the No. of Cycles, on delay, off delay of the corresponding relay in its timer mode. If the relay is configured in timer mode, then the timer can be turned ON by long press (about 3sec) of Up key while present in any of the measurement screens.

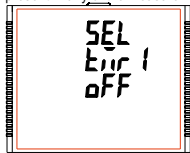

Relay 1 is not selected in Timer Configuration.

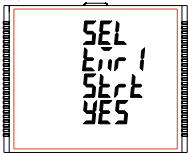

This screen is shown when relay is configured as timer by selecting yes option timer1 can be started.



Timer showing Running when it is started.

Similarly, the Relay can be turned OFF by long press (about 3sec) of Down key while present in any of the measurement screens.



Relay 1 is not selected in Timer Configuration.

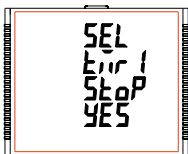

This screen is shown when timer is started by selecting yes option timer1 can be stopped.



Timer showing Stopped when not running.

Similarly, for Timer Configuration, Relay 2 parameters and status can also be set and accessed (respectively) in a way similar to that of Relay 1.

2.12 Run Hour



This Screen is one of the Energy Parameter Screens and shows the total no. of hours the load is connected. Even if the Auxiliary supply is interrupted, count of Run hour will be maintained in internal memory & displayed in the format "hours. min".

For example if Displayed count is 105000.10 it indicates 105000 hours & 10 minutes. After 999999.59 run hours display will restart from zero. To reset run hour manually see section Resetting Parameter 3.2.4.1.

2.13 On Hour

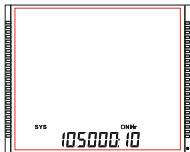

This Screen is one of the Energy Parameter Screens and shows the total no. of hours the Auxiliary Supply is ON. Even if the Auxiliary supply is interrupted count of On hour will be maintained in internal memory & displayed in the format "hours. min".

For example if Displayed count is 105000.10 it indicates 105000 hours and 10 minutes. After 999999.59 On hours display will restart from zero. To reset On hour manually see section Resetting Parameter 3.2.4.1.

2.14 Number of Interruption

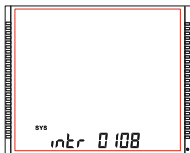

This Screen is one of the Energy Parameter Screens and Displays the total no. of times the Auxiliary Supply was Interrupted. Even if the Auxiliary supply is interrupted count will be maintained in internal memory. After 99999 counts, the number of interruptions will restart from zero. To reset No of Interruption manually see section Resetting Parameter 3.2.4.1

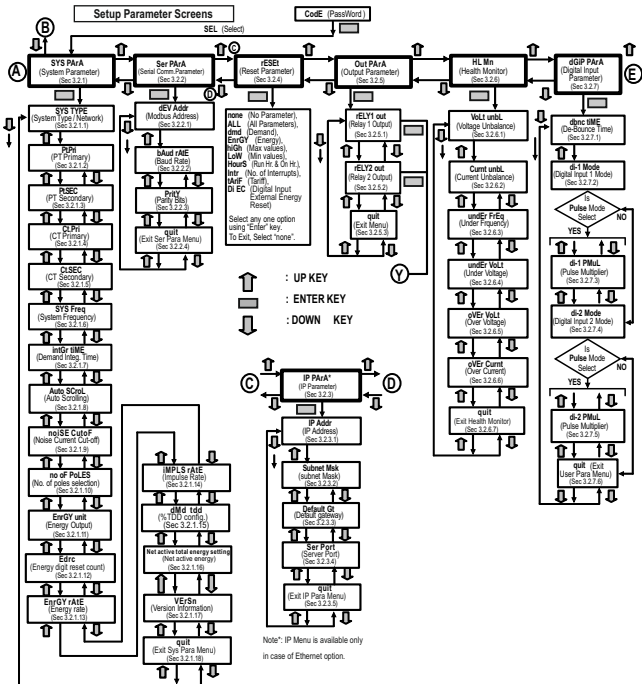

Setup Parameter Screens

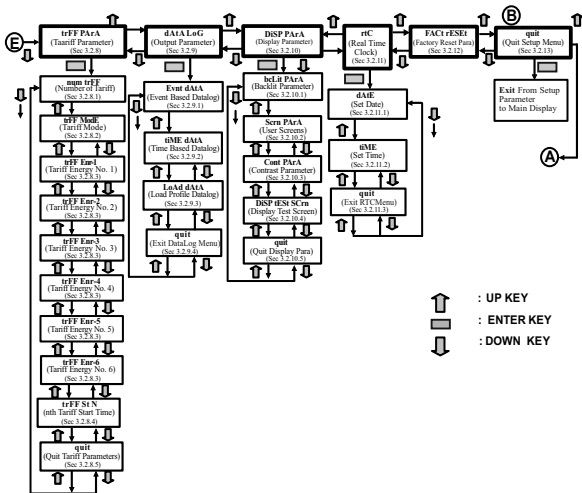

Output Options Parameters

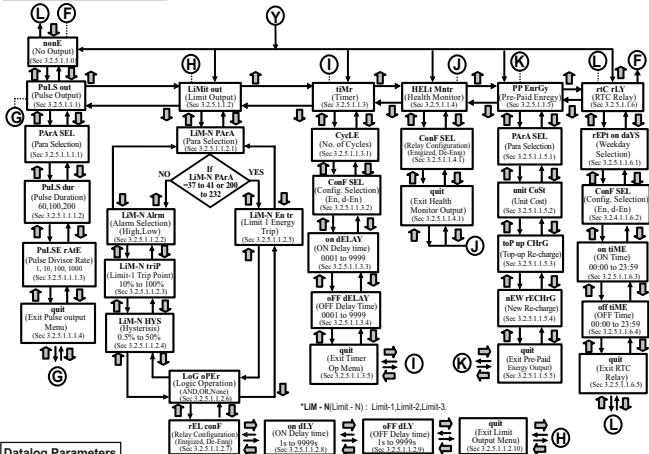

Datalog Parameters

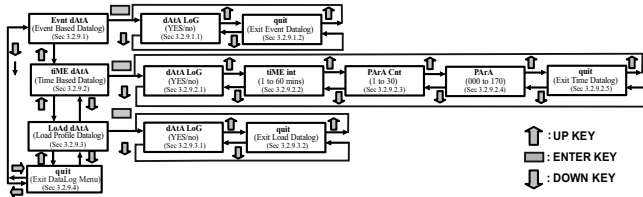

3. PROGRAMMING

The following sections comprise step by step procedures for configuring the Multifunction Meter according to individual user requirements. To access the set-up screens press and hold "▲ UP" and "▼ DOWN" keys simultaneously for 5 seconds. This will take the User into the Password Protection Entry Stage (Section 3.1).

3.1. Password Protection

Password protection can be enabled to prevent unauthorised access to set-up screens, when default password protection is not enabled. Password protection is enabled by selecting a four digit number other than 0000, setting a password of 0000 disables the password protection.

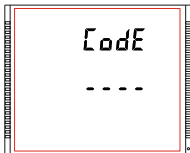

Enter Password, prompt for first digit. Press the "▲" key to scroll the value of first digit from 0 through to 9, the value rolls back from 9 round to 0 and "▼" key to scroll the value of first digit from 9 through to 0, the value rolls back from 0 round to 9.

Press the "←" key to advance to next digit.

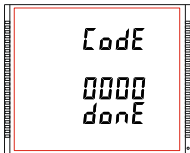

In special case where the Password is "0000" pressing the "←" key when prompted for the first digit advances to the password accepted screen and then pressing the "←" key again makes the set-up screens accessible to the user.

But instead of pressing the "←" key, if "▲" or "▼" key is pressed, the user is taken to the "New/change Password" entry stage.

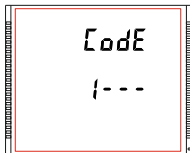

Enter Password, first digit entered, prompt for second digit..

Press the "▲" key to scroll the value of first digit from 0 through to 9, the value rolls back from 9 round to 0 and "▼" key to scroll the value of first digit from 9 through to 0, the value rolls back from 0 round to 9.

Press the "←" key to advance to next digit.

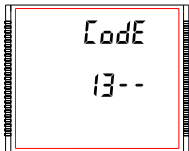

Enter Password, second digit entered, prompt for third digit.

Press the "▲" key to scroll the value of first digit from 0 through to 9, the value rolls back from 9 round to 0 and "▼" key to scroll the value of first digit from 9 through to 0, the value rolls back from 0 round to 9.

Press the "←" key to advance to next digit.

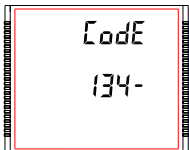

Enter Password, third digit entered, prompt for fourth digit .

Press the "▲" key to scroll the value of first digit from 0 through to 9, the value rolls back from 9 round to 0 and "▼" key to scroll the value of first digit from 9 through to 0, the value rolls back from 0 round to 9.

Press the "←" key to advance to verification of the password.

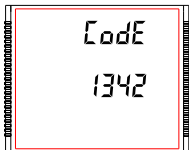

Enter Password, fourth digit entered, awaiting verification of the password.

Password confirmed.

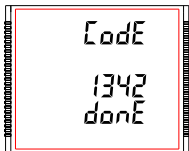

Pressing "▲" or "▼" key advances to the "New / change Password" entry stage.

Pressing the "←" key advances to the Menu selection (setup menu) screen (see Section 3.2).

Password Incorrect.

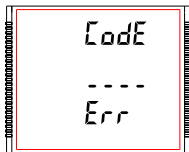

The unit has not accepted the Password entered.

Pressing the "▲" or "▼" key advances to the Enter Password stage.

Pressing the "←" key exits the Password menu & returns operation to the measurement reading mode.

New / Change Password

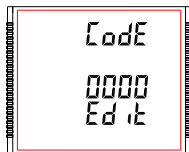

Prompting for first digit.

Press the "▲" and "▼" keys to scroll the value of first digit from 0 through to 9 and from 9 through to 0, respectively with digit roll around feature.

Pressing the "←" key advances the operation to the next digit and sets the first digit, in this case to "2".



New/ Change Password, first digit entered, prompting for second digit.

Press the "▲" and "▼" keys to scroll the value of second digit from 0 through to 9 and from 9 through to 0, respectively with digit roll around feature.

Pressing the "←" key advances the operation to the next digit and sets the second digit, in this case to "1".

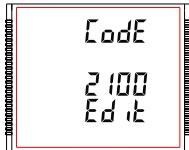

New/ Change Password, second digit entered, prompting for third digit.

Press the "▲" and "▼" keys to scroll the value of second digit from 0 through to 9 and from 9 through to 0, respectively with digit roll around feature.

Pressing the "←" key advance the operation to the next digit and sets the third digit, in this case to "5".

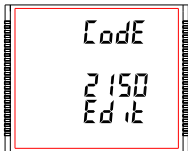

New/ Change Password, third digit entered, prompting for fourth digit .

Press the "▲" and "▼" keys to scroll the value of second digit from 0 through to 9 and from 9 through to 0, respectively with digit roll around feature.

Pressing the "←" key to advance the "New Password Confirmed" and sets the fourth digit, in this case to "3".

New Password confirmed

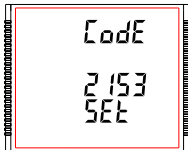

Pressing the "▲" or "▼" key returns to the "New/Change Password" stage.

Pressing the "←" key advances to the Menu selection screen (see Section 3.2).

3.2 Menu selection.

3.2.1 System Parameter Selection



This screen is used to select different system Parameters like "system type", "CT Primary", "PT Primary", etc. Pressing the "←" key allows the user to set Different system parameters (see Section 3.2.1.1 to 3.2.1.15).

Pressing the "▲" key advances to the "Communication Parameter Selection" screen (see section 3.2.2) and pressing "▼" key advances to the "Quit Setup" Screen (see section 3.2.11).

3.2.2 Communication Parameter Selection



This screen is used to select the different communication parameters like "Address selection", "RS485 Parity selection", "RS485 baud rate", etc. Pressing the "←" key allows the user to set different Communication parameters (see Section 3.2.2.1 to 3.2.2.3). Pressing the "▲" key advances to the "Reset Parameter Selection" screen (if ethernet module is present then it will advance to IP parameter selection see section 3.2.3) (see section 3.2.4) and pressing "▼" key advances to the "System Parameter Selection" screen (see Section 3.2.1).

3.2.3 IP Parameter Selection



This screen is used to select the different communication parameters like "IP Address selection", "Subnet mask selection", "default gateway selection", "server port selection etc. Pressing the "←" key allows the user to set different Ethernet parameters (see Section 3.2.3.1 to 3.2.3.4).

Pressing the "▲" key advances to the "Reset Parameter Selection" screen (see section 3.2.4) and pressing "▼" key advances to the "Communication Parameter Selection" screen (see Section 3.2.2).

3.2.4 Reset Parameter Selection



This screen is used to reset different parameters.

Pressing the "←" key allows the user to reset different parameters (see Section 3.2.4.1).

Pressing the "▲" key advances to the "Output Option Selection" screen (see Section 3.2.5) and pressing "▼" key advances to "Communication Parameter Selection" screen (see Section 3.2.2) (If ethernet module is present then it advances to IP parameter selection (see Section 3.2.3) else it goes to serial communication parameter selection).

3.2.5 Output Option Selection



This screen will allow the user to select Output Options like "Relay Output".

Pressing the "◀" key allows the user to select and configure the output options (see Section 3.2.5.1).

Pressing "▲" key advances to the "Health Monitor Parameters Selection" screen (see section 3.2.6) and pressing "▼" key advances to "Reset Parameter Selection" screen (see Section 3.2.4).

3.2.6 Health Monitor Parameters Selection



This screen will allow the user to configure Load health monitor parameters like "Unbalance voltage", "Unbalance current", "Under voltage", etc.

Pressing the "◀" key allows the user to select and configure the Load health parameters (see Section 3.2.6.1 to 3.2.6.6).

Pressing "▲" key advances to the "Digital Input parameter selection" screen (see section 3.2.7) and pressing "▼" key advances to "output option selection" screen (see Section 3.2.5)

3.2.7 Digital Input Parameter Selection



This screen will allow the user to configure "Digital Input" in different Modes.

Pressing the "◀" key allows the user to select and configure the feature (see Section 3.2.7.1 to Section 3.2.7.5).

Pressing the "▲" key advances to "Tariff Parameters" screen (see Section 3.2.8) and pressing "▼" key advances to "Health Monitor Parameters Selection" screen (see Section 3.2.6).

3.2.8 Tariff Parameter Selection



This screen will allow the user to select Tariff Parameter options like configuring the 6 tariff energies, No. of tariff, Tariff Mode.

Pressing the "◀" key allows the user to select and configure the parameter options.(see Section 3.2.8.1 to Section 3.2.8.3)

Pressing the "▲" key advances to Datalog option selection" screen (see Section 3.2.9) and pressing "▼" key advances to "Digital Input Parameter" screen (see Section 3.2.7).

3.2.9 Datalog Option Selection



This screen will allow the user to select Datalog Options like "Event Based", "Time Based" and "Load Profile".

Pressing the "◀" key allows the user to select and configure the datalog options (see section 3.2.9.1).

Pressing the "▲" key advances to "Display Parameters" screen (see section 3.2.10) and pressing "▼" key advances to "Tariff Parameter Selection" screen (see Section 3.2.8).

3.2.10 Display Parameter Selection



This screen will allow the user to access different features like "Backlit", "User Assignable Screens", "Contrast" and "Display Test Screen".

Pressing the "◀" key allows the user to select and configure the features (see Section 3.2.10.1).

Pressing the "▲" key advances to "RTC Setting" screen (see Section 3.2.11) and pressing "▼" key advances to "Datalog Option" screen (see Section 3.2.9).

3.2.11 RTC Setting

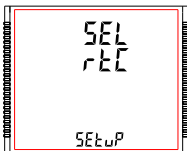

This screen will allow the user to access features like "Set Date" and "Set Time".

Pressing the "←" key allows the user to select date and time (see Section 3.2.11.1).

Pressing the "▲" key advances to "Factory Reset" screen (see Section 3.2.12) and pressing "▼" key advances to "Display Parameters" screen (see Section 3.2.10).

3.2.12 Factory Reset Selection



This screen allows the user to set the meter to its Factory Default settings. Pressing "←" key allows the user to configure the feature (see Section 3.2.12.1).

Pressing the "▲" key advances to "Quit Setup" screen (see Section 3.2.13) and pressing "▼" key advances to "RTC Setting" screen (see Section 3.2.11).

3.2.13 Quit Setup



This screen will allow the user to quit the setup menu (see Section 3.2.10.1)

Pressing the "←" key allows the user to Quit from setup menu & return to measurement screen.

Pressing the "▲" key advances to "System Parameter Selection" screen (see Section 3.2.1) and pressing "▼" key advances to "Factory Reset" screen (see Section 3.2.12).

3.2.1 System Parameter Selection

3.2.1.1 System Type



This screen is used to set the system type.

Pressing the "◀" key advances into the system type edit mode and pressing the "▲" and "▼" key scrolls through the options available:

System type "3P3W" for 3 phase 3 wire, "3P4W" for 3 phase 4 wire system & "1P2W" for 1 phase 2 wire, "1P3W" for 1 phase 3 wire & "2P2W" for 2 phase 2 wire system.

Pressing the "◀" key advances to "Pls Wait" screen, accepting the present value and returns to the "System Type" menu (see Section 3.2.1.1).



Once the System type is set and "System Type" menu appears (see Section 3.2.1.1), pressing "▲" key advances to the "Potential Transformer Primary Value" screen (see Section 3.2.1.2) and pressing the "▼" key advances to "Quit System Parameters" screen (see Section 3.2.1.6).

NOTE : Default value is set to 3P4W.

3.2.1.2 Potential Transformer Primary Value

The nominal full scale voltage is displayed as the **Line to Line** voltages for all system types. The values displayed represent the voltage in **kilovolts** (note "k" symbol).

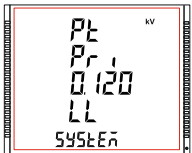

Pressing the "▲" key accepts the present value and advances to the "Potential Transformer Secondary Value" screen (see Section 3.2.1.3).

Similarly, pressing the "▼" key accepts the present value and advances to the "System Type" screen (see Section 3.2.1.1).

Pressing the "◀" key advances to the "Potential Transformer Primary Decimal Point Edit" mode.

Potential Transformer Primary Decimal Point Edit

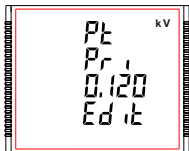

(Flashing decimal point indicates the cursor position). Initially the "decimal point must be selected, pressing the "▲" or "▼" key moves the decimal point position to the right until it disappears, which means that it has reached ####. after which it returns to #.###.

Note: The absence of decimal point in edit mode implies ####. decimal point position.

Pressing the "←" key accepts the present decimal point position and advances to the "Potential Transformer Primary Digit Edit" mode.

Potential Transformer Primary Digit Edit

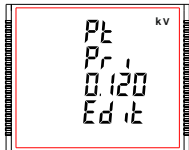

Pressing the "▲" or "▼" key scrolls the value of the most significant digit from 0 through 9 or 9 through 0, respectively unless the present displayed Potential Transformer Primary Value together with the Current Transformer Primary Value, previously set, results in a maximum system power of greater than 9000 MVA (3000 MVA per phase) in which case the digit range gets restricted.

Pressing the "←" key accepts the present value at the cursor position and advances the cursor to the next less significant digit.

The PT Primary value can be set from 100 VL- L to 1200 kVL-L. The value will be forced to previously set VL-L if set less than 100.

Note: The flashing digit indicates the cursor position, a steady decimal point is present to identify the scaling of the number until the cursor position coincides with the steady decimal point position. At this stage the digit will flash.

When the least significant digit has been set, pressing the "←" key shows "Pls Wait" screen which is followed by the "Potential Transformer Primary Value" screen (see Section 3.2.1.2).

Note : PT Values must be set as Line to Line Voltage for Primary as Well as Secondary for all system types (3P3W/3P4W/1P2W).

NOTE : The default value is '0.415 kVLL'.

3.2.1.3 Potential Transformer Secondary Value

The value must be set to the nominal full scale secondary voltage which will be obtained from the Transformer when the potential transformer (PT) primary is supplied with the voltage defined in 3.2.1.2 Potential Transformer Primary voltage. The ratio of full scale primary to full scale secondary is defined as the transformer ratio. The PT Secondary value can be set from 100VL-L to 600VL-L (according to input voltage range).

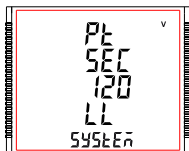

Pressing the "▲" key accepts the present value and advances to the "Current Transformer Primary Value" screen (see Section 3.2.1.4).

Similarly, pressing the "▼" key accepts the present value and advances to the "Potential Transformer Primary Value" screen (see Section 3.2.1.2). Pressing the "←" key advances to the "Potential Transformer Secondary Digit Edit" mode.

Potential Transformer Secondary Digit Edit

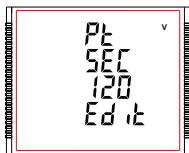

Pressing the "▲" or "▼" key scrolls the value of the most significant digit from 0 through 9 or 9 through 0, respectively.

Pressing the "←" key accepts the present value at the cursor position and advances the cursor to the next less significant digit.

After entering the least significant digit, pressing the "←" key sets the value and advances to the "Pls Wait" screen followed by the "Potential Transformer Secondary Value" screen (see Section 3.2.1.3).

NOTE : The default value is 415 VLL.

3.2.1.4 Current Transformer Primary Value

The nominal Full Scale Current that will be displayed as the Line currents. This screen enables the user to display the Line currents inclusive of any transformer ratios, the values displayed represent the Current in Amps.

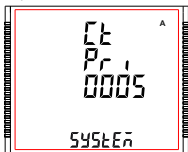

Pressing the "▲" key accepts the present value and advances to the "Current Transformer Secondary Value" screen (see Section 3.2.1.5).

Similarly, pressing the "▼" key accepts the present value and advances to the "Potential Transformer Secondary Value" menu (see Section 3.2.1.3).

Pressing the "◀" key advances to the "Current Transformer Primary Digit Edit" mode.

Current Transformer Primary Digit Edit

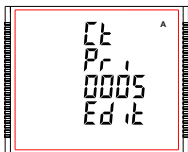

Pressing the "▲" or "▼" key scrolls the value of the most significant digit from 0 through 9 or 9 through 0, respectively (with digit roll over feature) unless the present displayed Current Transformer Primary Value together with the Potential Transformer Primary Value results in a maximum system power of greater than 9000 MVA (3000 MVA per phase) in which case the digit range gets restricted, the value will wrap.

Example: If primary value of PT is set as 1200 kVL-L (max value) then primary value of Current is restricted to 1804 A.

Pressing the " " key accepts the present value at the cursor position and advances the cursor to the next less significant digit.

The "Maximum Power" restriction of 9000 MVA refers to 120% of nominal current and 120% of nominal voltage, i.e. 3000 MVA nominal power per phase.

After entering the least significant digit, pressing the "◀" key sets the value and advances to the "Pls Wait" screen followed by "Current Transformer Primary Value" screen (see Section 3.2.1.4).

NOTE: Default value is set to '5' i.e. 5A.

3.2.1.5 Current Transformer Secondary Value

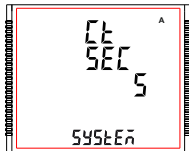

This screen is used to set the secondary value for Current Transformer. Secondary value "5" for **5A** or "1" for **1A** can be selected.

Pressing the "▲" key accepts the present value and advances to the "System Frequency" menu (see Section 3.2.1.6).

Similarly, pressing the "▼" key accepts the present value and advances to the "Current Transformer Primary Value" screen (see Section 3.2.1.4).

Pressing the "◀" key advances to the "CT Secondary Value Edit" mode and keys "▲" and "▼" scroll the value through the options available.

Pressing the "↵" key sets the option selected and advances to "Pls Wait" screen followed by "Current Transformer Secondary Value" screen (see Section 3.2.1.5).

NOTE: Default value is set to '5' i.e. 5A.

3.2.1.6 System Frequency

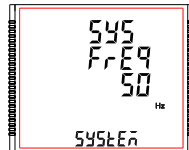

This screen is used to set the frequency of the input. The Unit of displayed values is Hz.

Pressing the "◀" key enables editing and pressing the "▲" or "▼" key scrolls through the following Options: **50,60** Hz.

Once the desired option has been selected, pressing "◀" key confirms the selection and advances to the "System Frequency" menu (see Section 3.2.1.6).

Pressing the "▲" key advances to "Demand Integration Time" screen (see Section 3.2.1.7) and pressing the "↵" key advances to "Current Transformer Secondary Value" screen (see Section 3.2.1.5).

**NOTE : (1) The applied frequency and the entered frequency value should be same.
(2) Default value is set to '50' Hz.**

3.2.1.7 Demand Integration Time

This screen is used to set the period over which current and power readings are to be integrated. The Unit of displayed value is **minutes**.

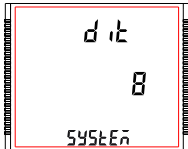

Pressing the "◀" key enables editing and pressing keys "▲" and "▼" allows scrolling to select desired value. The user can select value upto 60 min.

Once the desired value is selected, pressing "◀" key confirms the selection and advances to "Pls Wait" screen followed by "Demand Integration Time" screen (see Section 3.2.1.7).

Pressing the "▲" key advances to "Auto Scrolling" screen (see Section 3.2.1.8) and pressing the "▼" key advances to "System Frequency" screen (see Section 3.2.1.6). **NOTE: Default value is set to '8' i.e. 8 min.**

3.2.1.8 Auto Scrolling

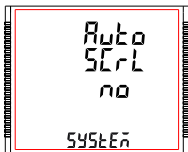

This screen allows user to enable auto screen scrolling.

Pressing "▲" key accepts the present status and advance to the "Low Current Noise Cutoff" screen (see Section 3.2.1.9). Similarly, pressing "▼" key accepts the present status and advances to the "Demand Integration Time" screen (see Section 3.2.1.7).

Pressing the "◀" key allows editing and keys "▲" and "▼" allows the user to select either 'Yes' to enable autoscroll and 'No' to disable autoscroll.

Pressing "◀" key selects the status displayed and advances to "Auto Scrolling" screen (see Section 3.2.1.8).

NOTE: (1) Default value is set to 'NO'.

(2) With Autoscrolling mode ON, Menu screens(e.g. health monitor, prepaid energy, individual harmonics) can be scrolled automatically by pressing "◀" key on that particular menu.

3.2.1.9 Low Current Noise Cutoff

This screen allows the user to set Low noise current cutoff in **mA**.

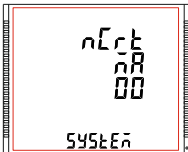

Pressing "▲" key accepts the present value and advance to "No. of Poles" screen (see Section 3.2.1.10). Similarly, pressing "▼" key accepts the present value and advance to "Auto Scrolling" screen (see Section 3.2.1.8).

Pressing the "◀" key allows editing and the user can select value upto 30 mA using "▲" and "▼" keys.

Setting 30 displays measured currents as 0 if it is below 30 mA.

Pressing the "←" key confirms the selection and advances to "Low Current Noise Cutoff" screen (see Section 3.2.1.9).

NOTE: Default value is set as '0' mA.

3.2.1.10 No. of Poles

This screen enables to set No. of poles of a Generator of which RPM is to be measured and to which the instrument is connected to monitor its parameters.

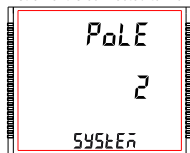

Pressing "▲" key accepts the present selection and advances to "Energy Unit" menu (see Section 3.2.1.11). Similarly, pressing "▼" key accepts the present selection and advances to "Low Current Noise Cutoff" screen (See section 3.2.1.9).

Pressing the "←" key advances to editing mode for no. of poles and pressing "▲" and "▼" keys scrolls the number from 2 to 40 and 40 to 2, respectively in steps of 2.

Pressing the "←" key selects the status displayed and enter the "No. of Poles" menu (see Section 3.2.1.10).

NOTE: Default value is set to '2'.

3.2.1.11. Energy Output

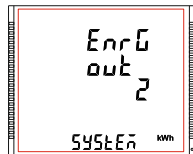

This screen enables user to set energy on modbus in terms of Wh / kWh / MWh as per the requirement. Same is applicable to all types of energy.

Pressing "▲" key accepts the present value and advances to the "Energy Digit Reset Count" screen (see Section 3.2.1.12).

Similarly, pressing "▼" key accepts the present value and advances to the "No. of Poles" menu (see Section 3.2.1.10).

Pressing the "←" key will enter the editing mode for energy unit and "▲" and "▼" keys scrolls through the values 1,2 & 3 and in the reverse order, respectively, with roll over feature:

1 : Energy In Wh

2 : Energy in kWh

3 : Energy in MWh

Pressing the "←" key sets the value selected and advances to "Pls Wait" screen followed by "Energy Output" menu (see Section 3.2.1.11).

- NOTE: 1. Default value is set to '2' i.e. Energy will be in terms of kWh/kVAh/kVAh respectively.
 2. If $(PT \text{ primary(VLL)} * CT \text{ primary} * \text{Root3}) > 30000 \text{ kW}$, then Energy Output can be set only as kWh and MWh.
 3. Energy on display is auto-ranging & so this setting is only applicable for modbus energy counters.
 (For Energy auto-ranging refer Section 4.1.)

3.2.1.12 Energy Digit Reset Count

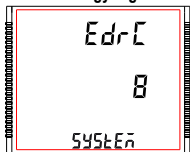

This screen enables user for setting maximum energy count after which energy on modbus will roll over to zero. User can select one of: **7,8,9**.

Pressing the "▲" key accepts the present value and will advance to the "Energy Rate" screen (see Section 3.2.1.13). Similarly, pressing the "▼" key accepts the present value and will advance to the "Energy Unit" menu (see Section 3.2.1.11).

Pressing the "◀" key advances to the Energy Digit Reset Count edit mode. Pressing the "▲" and "▼" key will scroll the value of reset count from 7 to 9 and 9 to 7, respectively with rollover feature.

Ex. If Energy Digit count is set to 9 then energy on modbus will reset after "999,999,999" & rollback to zero and simultaneously the corresponding **Overflow count** value increases by 1.

Pressing "◀" key sets the value selected and advances to "Pls Wait" screen followed by "Energy Digit Reset Count" screen (see Section 3.2.1.12).

- NOTE :** (1) Default value is set to '8' i.e. if energy count crosses 8 digits, then it will reset to zero.
 (2) Energy on Display is Auto-Ranging (for details see Section 4.1)

3.2.1.13 Energy Rate

This screen allows user to enter energy update rate in minutes. After entering particular value in minutes, the energy will be updated on modbus location of 3X register and 4X register as per value that user has entered.

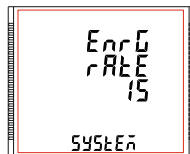

The user can select any integral value between **1 and 60** minutes.

Pressing the "▲" key accepts the present value and advances to "Impulse rate" screen (see Section 3.2.1.14).

Similarly, pressing the "▼" key accepts the present value and advances to "Energy Digit Reset Count" screen (see Section 3.2.1.12).

Pressing the "←" key advances to the Energy Rate edit mode. Pressing "▲" and "▼" scrolls the count in minutes from 1 to 60 and from 60 to 1, respectively. **Ex.** If Energy Rate is set to 2 then energy will get stored after 2 minutes on the modbus.

Pressing "←" key sets the value selected and advances to the "Energy Rate" menu (see Section 3.2.1.13).

NOTE: Default value is set to '15' i.e. 15 min.

3.2.1.14 Impulse Rate

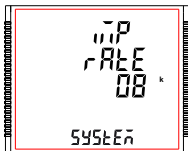

This screen shows user to Impulse rate depending upon the PT secondary and CT Secondary set by user.

'k' indicates value is multiplied by 1000.

Pressing the "▲" key advances to "Version Information" screen (see Section 3.2.1.15). Similarly, pressing the "▼" key advances to "Energy Rate" screen (see Section 3.2.1.13).

System nominal power	Impulse constant
<=100	64000
<=200	32000
<=400	16000
<=800	8000
<=1600	4000
<=3200	2000
>3200	1000

11. For per phase / 1P2W / 2P2W System Energy,

$$\text{Nominal Power} = \text{PT Sec (LL)} * \text{CT Sec} / 1.732$$

2. For 1P3W System Energy,

$$\text{Nominal Power} = 2 * \text{PT Sec (LL)} * \text{CT Sec} / 1.732$$

3. For Three Phase System Energy,

$$\text{Nominal Power} = 3 * \text{PT Sec (LL)} * \text{CT Sec} / 1.732.$$

3.2.1.15 Max Current Demand for TDD

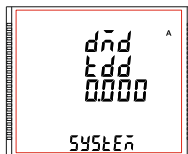

This Screen allows user to configure maximum current demand value manually for %TDD current calculation.

According to IEEE std 519, %TDD current is calculated using formula:-

$$I_{TDD} = \frac{\sqrt{I_2^2 + I_3^2 + I_4^2 + I_5^2 + \dots + I_{31}^2}}{I_L} \times 100\%$$

where, I_2^2, I_3^2, I_4^2 upto I_{31}^2 are Harmonic Current values

I_L = Maximum Current Demand

configured maximum current demand value on this screen is less than measured maximum current demand value, then the value which is greater is taken into consideration for %TDD current calculation. If configured maximum current demand value is set to zero then, the measured maximum current demand will be used for calculating %TDD value.

Pressing the "▲" key accepts the present value and will advance to the "Net active total energy setting" screen (see Section 3.2.1.16). Similarly, pressing the "▼" key accepts the present value and will advance to the "Impulse Rate" screen (see Section 3.2.1.14).

Pressing the "←" key advances to edit mode.

Edit mode

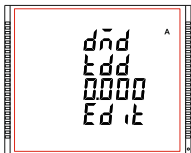

(Flashing decimal point indicates the cursor position). Initially the "decimal point must be selected, pressing the "▲" or "▼" key moves the decimal point position to the right & left respectively until it disappears, which means that it has reached ###.#. after which it returns to #.### or ##.#.

Pressing the "←" key accepts the present decimal point position and advances to first digit. Press the "▲" and "▼" keys to scroll the values of the first digit.

Press the "→" key to advance to next digit. Similarly, enter second, third and fourth digits also. **Value ranges from 0 to 9999 A**

Note: Default value is set to 0.

3.2.1.16 Net Active Total Energy

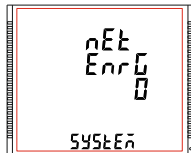

This screen shows user the current net active total energy setting, currently it shows 0 means net active total energy will be calculated according to **import - export** and if user select 1, it means net active total energy will be calculated according to **export - import**.

Pressing the "▲" key advances to "Version Info" screen (see Section 3.2.1.17). Similarly, pressing the "▼" key advances to "Max current TDD" screen (see Section 3.2.1.15).

Note: Default value is set to "0"

3.2.1.17 Version Number

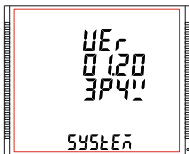

This screen shows user the current firmware version implemented in the instrument and the selected system type.

e.g.The image here displays that the firmware version is 01.20 and the instrument is currently in three phase four wire.

Pressing the "▲" key advances to "quit" screen (see Section 3.2.1.18). Similarly, pressing the "▼" key advances to "Max current TDD" screen (see Section 3.2.1.15).

3.2.1.18 Quit System Parameters

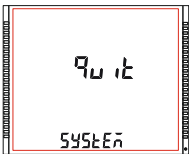

This screen allows user to Exit from System Parameter selection setup.

Pressing the "▲" key advances to "System Type" screen (see Section 3.2.1.1). Similarly, pressing the "▼" key advances to "Version Information" screen (see Section 3.2.1.15). Pressing the "◀" key advances to "Communication Parameter Selection" screen (see Section 3.2.1).

3.2.2 Communication Parameter Selection

3.2.2.1 Address Setting



This screen applies to the RS 485 output only. This screen allows the user to set RS 485 address for the meter.

The allowable range of addresses is 1 to 247.

Press "▲" key to advance to "RS 485 Baud Rate" screen (see Section 3.2.2.2) or press the "▼" key to advance to the "Quit Communication Parameters" screen (see Section 3.2.2.4).



Press "←" to enter into edit mode, prompt for first digit.

Press the "▲" and "▼" keys to scroll the value of the first digit. Press the "←" key to advance to next digit.

Similarly, enter second and third digits of address. After entering third digit, pressing "←" key confirms the selection and shows "Address Setting" screen (see Section 3.2.2.1).

NOTE : The default setting is '1'.

3.2.2.2 RS 485 Baud Rate

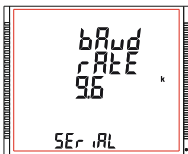

This screen allows the user to set Baud Rate of RS 485 port. The values displayed on screen are in kbaud.

Pressing "▲" key accepts the present value and advance to the "RS 485 Parity Selection" screen (see Section 3.2.2.3) and pressing the "▼" key accepts the present value and advance to the "Address Setting" screen (see Section 3.2.2.1).

Pressing the "←" key advances to the "Baud Rate Edit" mode and "▲" & "▼" keys scrolls the value through **4.8, 9.6, 19.2, 38.4 and 57.6** kbaud.

Pressing the "←" key sets the value and shows the "RS 485 Baud Rate" screen (see Section 3.2.2.2).

NOTE: Default value is set as '9.6'.

3.2.2.3 RS 485 Parity

This screen allows the user to set Parity & number of stop bits of RS 485 port.

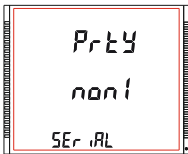

Pressing "▲" key accepts the present value and advances to "Quit Communication Parameters" screen (see section 3.2.2.4). Similarly, pressing "▼" key accepts the present value and advances to "RS 485 Baud Rate" screen (see section 3.2.2.2).

Pressing the "←" key advances to the "Parity & Stop bit Edit" mode & keys "▲" and "▼" scrolls the value through:
nonE1 : no parity with one stop bit **nonE2** : no parity with two stop bit
EVEN : even parity with one stop bit **odd** : odd parity with one stop bit

Pressing "←" key sets the value and advances to "RS 485 Parity Selection" screen (see Section 3.2.2.3).

NOTE: Default value is set as 'nonE1'.

3.2.2.4 Add-on card Baud Rate



This screen allows the user to set Add-on Card Baud Rate. The values displayed on screen are in kbaud.

Pressing "▲" key accepts the present value and advance to the "Quit Communication Parameters" screen (see Section 3.2.2.5) and pressing the "▼" key accepts the present value and advance to the "RS 485 Parity Selection" screen (see Section 3.2.2.3).

Pressing the "←" key advances to the "Add-on Card Baud Rate Edit" mode and "▲" & "▼" keys scrolls the value through 19.2 and 38.4 kbaud.



After configuring the add-on card baud rate, the display shows "PLS rStrt", indicating that the user must power OFF and then power ON the meter.

NOTE: Default value is set as '19.2'.

***NOTE:-** An add-on card identification sticker is provided for reference. If "BACnet Version:" indicated on the sticker is 1.1 or above, the user must set the add-on card baud rate to 38.4 kbaud for successful communication. If there is no version present on sticker, the baud rate must be set to 19.2 kbaud.



3.2.2.5 Quit Communication Parameters

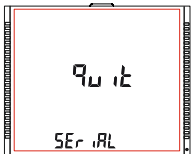

This screen allows user to exit from system "Communication Parameter Selection" setup.

Pressing the "▲" key advances to "Address Setting" screen (see Section 3.2.2.1). Similarly, pressing the "▼" key advances to "Addon Card Baud rate" screen (see Section 3.2.2.4).

Pressing the "←" key advances to "Communication Parameter Selection" screen (see Section 3.2.2).

3.2.3 IP Parameter Selection

3.2.3.1 IP Address Setting

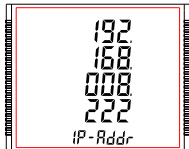

This screen allows the user to set Ip address.

Pressing "▼" key accepts the present value and advance to the "Quit Ip parameters" screen (see Section 3.2.3.5) and pressing the "▲" key accepts the present value and advance to the "Subnet Mask Setting" screen (see Section 3.2.3.2).

Pressing the "←" key advances to the "IP address Edit" mode

Pressing the "←" key sets the value and shows the "IP address Edit Screen" (see Section 3.2.3.1).

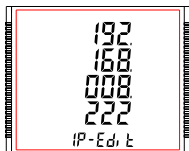

Pressing the "▲" or "▼" key scrolls the value of the most significant digit from 0 through 9 or 9 through 0, respectively

Pressing the "←" key accepts the present value at the cursor position and advances the cursor to the next less significant digit.

user can set value from 000.000.000.000 to 255.255.255.255.

After entering the least significant digit, pressing the "←" key sets the value

3.2.3.2 Subnet Mask Setting

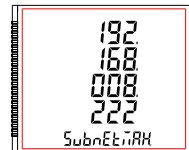

This screen allows the user to set Subnet Mask.

Pressing "▼" key accepts the present value and advance to the "IP address setting" screen (see Section 3.2.3.1) and pressing the "▲" key accepts the present value and advance to the "Default gateway Setting" screen (see Section 3.2.3.3).

Pressing the "←" key advances to the "Subnet Mask Edit" mode

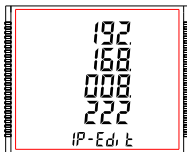

Pressing the "▲" or "▼" key scrolls the value of the most significant digit from 0 through 9 or 9 through 0, respectively
Pressing the "←" key accepts the present value at the cursor position and advances the cursor to the next less significant digit.
user can set value from 000.000.000.000 to 255.255.255.255.
After entering the least significant digit, pressing the "←" key sets the value

3.2.3.3 Default Gateway Setting

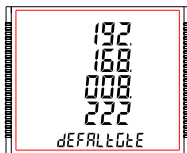

This screen allows the user to set Default Gateway.
Pressing "▼" key accepts the present value and advance to the "Subnet Mask setting" screen (see Section 3.2.3.2) and pressing the "▲" key accepts the present value and advance to the "Server port Setting" screen (see Section 3.2.3.4).

Pressing the "←" key advances to the "Default Gateway Edit" mode

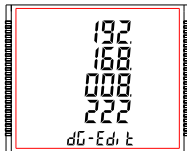

Pressing the "▲" or "▼" key scrolls the value of the most significant digit from 0 through 9 or 9 through 0, respectively
Pressing the "←" key accepts the present value at the cursor position and advances the cursor to the next less significant digit.
user can set value from 000.000.000.000 to 255.255.255.255.
After entering the least significant digit, pressing the "←" key sets the value

3.2.3.4 Server Port Settings

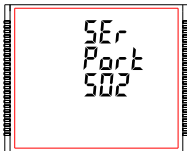

This screen allows the user to set Server Port for the meter. The allowable range of addresses is 001 to 999.

Press "▼" key to advance to "Default Gateway" screen (see Section 3.2.3.3) or press the "▲" key to advance to the "Quit IP Parameters" screen (see Section 3.2.3.5).

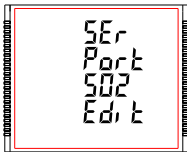

Press "←" to enter into edit mode, prompt for first digit.

Press the "▲" and "▼" keys to scroll the value of the first digit. Press the "←" key to advance to next digit.

Similarly, enter second and third digits of address. After entering third digit, pressing "←" key confirms the selection and shows "Server Port Setting" screen (see Section 3.2.3.4).

The default setting is '502'.

3.2.3.5 Quit IP Parameters

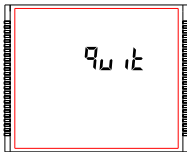

This screen allows user to exit from "IP Communication Parameter Selection" setup.

Pressing the "▼" key advances to "Server Port Selection" screen (see Section 3.2.3.4). Similarly, pressing the "▲" key advances to "IP address Selection" screen (see Section 3.2.3.1).

Pressing the "←" key advances to "IP Parameter Selection" screen (see Section 3.2.3).

3.2.4 Reset Parameter Selection

3.2.4.1 Resetting Parameter

This screen allows the users to reset Energy, Low(Min), high(Max), Demand, Run hour, On hour, No. of Interrupts, Tariff, Digital Input External Energy.

Reset Parameters

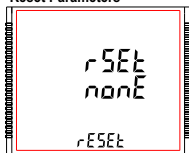

Reset (None)

Pressing "←" key advances to "Reset Parameters" screen. Pressing the "▲" or "▼" key advances to "Reset Parameter Selection" screen (see section 3.2.4).

Pressing the "↵" key advances to edit mode.

Edit mode

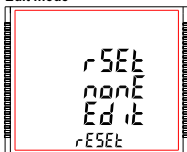

Pressing "▲" & "▼" keys scroll through the parameters given below:

ALL : reset all resettable parameters

dmd : reset all demand parameters

EnrGy : reset all energies

HIGH : reset maximum values of voltage & current

LoW : reset minimum values of voltage & current

hours : reset run hour & on hour

intr : reset no. of auxiliary supply interruption count

trFF : reset the tariff based energies.

Cntr : reset the digital input external energy count.

time LoG : reset the time based datalog buffer to store no values

LoAd LoG : reset the load profile datalog buffer to store no values

Pressing the "←" key advances to "Pls Wait" screen and resets the parameter selected followed by "Reset Parameters" screen.

Pressing the "↵" key advances to "Reset option" mode and pressing "▲" and "▼" keys advances to "Reset Parameter Selection" screen (see Section 3.2.4).

3.2.5. Output Option Selection

This screen applies to the relay output option selection. Pressing "◀" key advances to "Relay Selection" menu (see Section 3.2.5.1).

3.2.5.1 Relay Selection

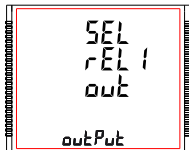

Pressing "▲" and "▼" keys scrolls through the following screens:

rEL1 : To select options for relay 1 (See section 3.2.5.1.1).

rEL2 : To select options for relay 2 (See section 3.2.5.1.1).

quit : To exit the Output Options menu and give the "Output Option Selection" screen (see Section 3.2.5).

Pressing "◀" key advances to Relay1 or 2 Output Selection menu (see Section 3.2.5.1.1).

3.2.5.1.1 Relay 1 or 2 Output Selection Menu

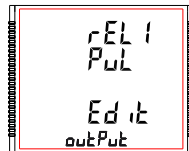

Pressing "◀" key makes the following options available for relay1 and relay2:

0. None : No Parameter selected for Relay output (see Section 3.2.5.1.1.0)

1. Pulse : Relay in Pulse output mode (see Section 3.2.5.1.1.1)

2. Limit : Relay in Limit output mode (see Section 3.2.5.1.1.2)

3. Timer : Relay in Timer output mode (see Section 3.2.5.1.1.3)

4. Load Health : Relay in Load Health mode (see Section 3.2.5.1.1.4)

5. Pre Paid Energy : Relay in Pre Paid Energy mode
(see Section 3.2.5.1.1.5)

6. RTC Relay: Relay in RTC Output Mode(3.2.5.1.1.6)

Press "▲" and "▼" keys to navigate between the above options and press "◀" key to confirm the selection.

NOTE : The default option is set as 'None'.

3.2.5.1.1.0 None Output

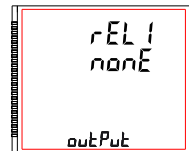

This screen is used to set the none output parameter.

Pressing "▲" key advances to "Relay Selection" screen (see Section 3.2.5.1) whereas pressing "▼" key advances to "Relay Selection" menu.

3.2.5.1.1.1 Pulse Output

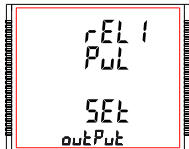

This screen is used to set the pulse output parameter.

Pressing "▲" key advances to "Parameter Selection" screen (see Section 3.2.5.1.1.1.1) whereas pressing "▼" key advances to "Quit Pulse Output" menu (see Section 3.2.5.1.1.1.4).

3.2.5.1.1.2 Limit Output

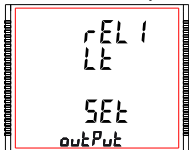

This screen is used to assign Relay in Limit output mode.

Pressing "▲" key shows "Parameter Selection" screen (see Section 3.2.5.1.1.2.1) whereas pressing "▼" key shows the "Quit Limit Output" screen (see Section 3.2.5.1.1.2.10).

3.2.5.1.1.3 Timer

3.2.5.1.1.3 Timer Output

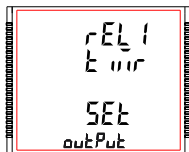

This screen is used to assign Relay in Timer output mode.

Pressing "▲" key will give the Number of Cycles menu (see Section 3.2.5.1.1.3.1) whereas pressing "▼" key gives the Quit Timer output menu (see Section 3.2.5.1.1.3.5).

3.2.5.1.1.4 Load Health Monitor Output



This screen is used to assign Relay in Load Health Monitor output mode.

Pressing "▲" key advances to "Load Health Monitor Configuration" menu (see Section 3.2.5.1.1.4.1) whereas pressing "▼" key advances to "Quit Load Health Output" menu.

3.2.5.1.1.5 Pre Paid Energy Output



This screen is used to assign Relay in Pre Paid Energy output mode.

Pressing "▲" key advances to "Parameter Selection" menu (see Section 3.2.5.1.1.5.1) whereas pressing "▼" key advances to "Quit Pre Paid Energy Output" menu (see Section 3.2.5.1.1.5.5).

3.2.5.1.1.6 RTC Relay



This screen is used to assign Relay in RTC output mode.

Pressing "▲" key advances to "Weekdays Selection" menu (see Section 3.2.5.1.1.6.1) whereas pressing "▼" key advances to "Quit RTC Output" menu (see Section 3.2.5.1.1.6.5).

3.2.5.1.1.1 Parameter Selection

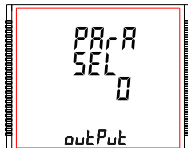

This screen allows the user to assign energy for pulse output. Pressing "▲" key accepts the present setting and advance to "Pulse duration selection" (see section 3.2.5.1.1.1.2) and pressing "▼" key accepts the present setting and advance to "Quit Relay Output" selection (see section 3.2.5.1.1.1.4).

Pressing the "◀" key advances to edit mode and "▲" and "▼" keys scrolls through the values, as per TABLE 2.1, "parameters for pulse output".

Edit mode

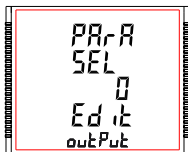

Pressing the "◀" key sets the value & gives the "Parameter Selection" menu (see section 3.2.5.1.1.1.1).

NOTE: Default configuration is set as '0', i.e., System Wh Import.

3.2.5.1.1.2 Pulse Duration

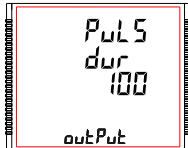

This screen applies only to the Pulse output mode of relay. This screen allows the user to set Relay energization time in milliseconds.

Pressing "▲" key accepts the present value and advance to "Pulse Rate" screen (see section 3.2.5.1.1.1.3). Similarly, pressing "▼" key accepts the present value and advance to "Parameter Selection" screen (see section 3.2.5.1.1.1.1).

Pressing the "◀" key advances to "Pulse Duration Edit" mode and "▲" and "▼" keys scroll the value through **60, 100 and 200** ms.

Pressing the "◀" key selects the value and advances to "Pulse Duration " menu (see Section 3.2.5.1.1.1.2).

NOTE: Default value is set to '100' ms.

3.2.5.1.1.3 Pulse Rate



This screen applies to the Pulse Output option only. The screen allows user to set the Energy Pulse Rate divisor. Divisor values can be selected through **1,10,100,1000** as per Energy Unit (refer Section 3.2.1.11) set. Refer **TABLE 2.2** "Energy Pulse Rate Divisor" for details.

Pressing "▲" key accepts the present selection and takes to the "Quit Pulse Output" menu (See section 3.2.5.1.1.4) and pressing "▼" key accepts the present selection and takes to the "Pulse Duration" screen (see Section 3.2.5.1.1.2).

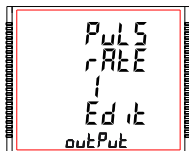

Pressing the "←" key advances to "Pulse Rate Divisor Edit" mode & keys "▲" and "▼" scrolls the value through the values 1,10,100 and 1000.

Pressing the "↩" key gives the "Pulse Rate" screen (see Section 3.2.5.1.1.3).

The default setting is '1'.

Note: If energy unit/resolution is in kWh or MWh then value is default 1.

3.2.5.1.1.4 Quit Pulse Output

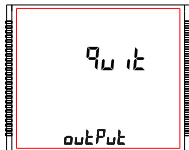

The screen allows user to exit the Pulse Output selection menu.

Pressing "▲" key advances to the "Pulse Output" menu (see Section 3.2.5.1.1.1) and pressing "▼" key advances to the "Pulse Rate" menu (See section 3.2.5.1.1.3).

Pressing "↩" key advances to the "Relay Selection" menu (see Section 3.2.5.1).

3.2.5.1.1.2.1 Limit Output Parameters

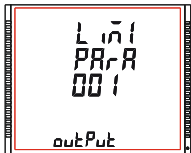

This screen is for **Limit output mode selection**. It allows the user to set Limit output corresponding measured value. Refer **TABLE 3** "Parameter for Limit output" for assignment.

Pressing "▲" key accepts the present parameter and for energy parameters 37 to 41 and 200 to 232 as present value, advances to the "Energy Trip Point" screen (see section 3.2.5.1.1.2.5) whereas for other values, advances to the "Alarm Configuration" screen (see Section 3.2.5.1.1.2.2).

Whereas pressing "▼" key accepts the present parameter and advances to the selected "Relay Limit Output" screen (see section 3.2.5.1.1.2).

Pressing the "←" key advances to "Relay Limit Parameter Selection" mode and "▲" and "▼" keys scrolls the values, as per **TABLE 3**, "Parameter for Limit Output".

Again, Pressing the "←" key advances to "Limit Output Parameters" menu screen (see Section 3.2.5.1.1.2.1).

3.2.5.1.1.2.2 Alarm Configuration

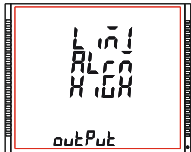

This screen is used to set the Alarm Configuration for Relay.

Selecting values other than 37 to 41 and 200 to 232 as Limit Output Parameter (see section 3.2.5.1.1.2.1) allows the user select one of the following configurations:

High (To Operate the Relay when selected parameter value is greater than trip point)

Low (To Operate the Relay when selected parameter value is less than trip point)

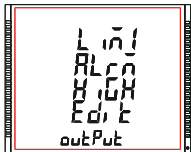

Pressing the "▲" key accepts the present selection and advances to the "Trip Point" screen (see section 3.2.5.1.1.2.3) and pressing the "▼" key accepts the present selection and advances to the "Limit Output Parameters" screen (see section 3.2.5.1.1.2.1).

Pressing the "←" key advances to Alarm Configuration edit mode and "▲" and "▼" keys scrolls through the available configurations.

Pressing the "←" key sets the displayed value and advances to "Alarm Configuration" Screen (see Section 3.2.5.1.1.2.2).

NOTE: Default configuration is set to 'High'.

Similarly, Limit - 2 and Limit - 3 parameters can be configured to set the alarm for relay in a similar way to that of Limit - 1 (Given that one of the two Logic Operations (see Section 2.5.1.1.2.6) is active)

3.2.5.1.1.2.3 Trip Point

This screen applies to Trip point selection for parameters other than 37 to 41 & 200 to 232 (Refer **TABLE 3**) selected in Section 3.2.5.1.1.2.1.

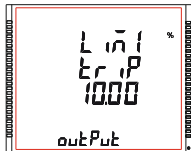

This screen allows the user to set Trip point for selected limit relay. The allowable range is **10% to 120% for High Alarm**, **10% to 100% for Low Alarm** (refer **TABLE 3**).

Pressing the "▲" key accepts the present value and advances to the "Hysteresis" screen (see section 3.2.5.1.1.2.4) and pressing the "▼" key accepts the present value and advances to the "Alarm Configuration" screen (see Section 3.2.5.1.1.2.2).

Pressing "←" key prompts the first decimal. Press the "▲" and "▼" keys to scroll the decimal position. Again, pressing the "←" key prompts the first digit, and pressing "▲" & "▼" key scroll through the value of the first digit. Pressing "←" key prompts the second digit. Similarly, enter third and fourth digits also.

Note: Default value is set to '10.00' %.

3.2.5.1.1.2.4 Hysteresis

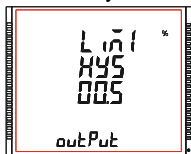

This screen applies to the Hysteresis selection. This screen allows the user to set Hysteresis for relay output.

The allowable range is **0.5% to 50.0 %** of Trip point.

Pressing the "▲" key accepts the present value and advances to the "Logic Operation Selection" screen (see Section 3.2.5.1.1.2.6) and pressing the "▼" key accepts the present value and advances to the "Trip Point" screen (see Section 3.2.5.1.1.2.3).



Pressing "←" key prompts for first digit. Press the "▲" and "▼" key to scroll the value of the first digit. Press the "←" key to advance to next digit.

The second digit prompts. Press "▲" and "▼" keys to scroll through 0 and 9 and "←" key to set the digit and advance to the third digit. The third digit prompts. Press "▲" and "▼" keys to scroll through 0 and 9.

Press "←" to confirm the value and advance to "Hysteresis" screen (see Section 3.2.5.1.1.2.4). Refer Section 5.2 for further details.

Note: Default value is set to '00.5' %.

3.2.5.1.1.2.5 Energy Trip Point

This screen applies to the Energy Trip point selection for parameters 37 to 41 and 200 to 232 (Refer **TABLE 3**) selected in Section 3.2.5.1.1.2.1.

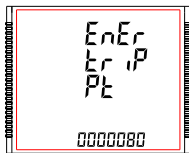

This screen is used to trip the relay using the energy count. The relay trips after the lapse of "ON Delay" time (see Section 3.2.5.1.1.2.8) from the moment the energy count reaches the value of Energy Trip Point set by the user in addition to its value at the moment the Energy Trip Point is set.

Pressing the "▲" key accepts the present value and advances to the "Logic Operation Selection" screen (see Section 3.2.5.1.1.2.6) and pressing the "▼" key accepts the present value and advances to the "Limit Output Parameters" screen (see Section 3.2.5.1.1.2.1).

Pressing the "◀" key advances to Energy Count Configuration edit mode.

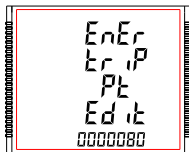

Press "◀" key, prompt for the first digit.

Press the "▲" and "▼" keys to scroll the value between 0 and 9, whereas Press the "◀" key to lock the present selection and advance to next digit.

Similarly, lock the value of all the remaining digits of the 7 digit count in a similar way until the last digit is reached.

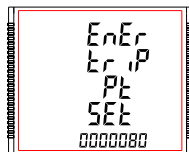

Pressing the "◀" key for the last digit sets the value for Energy Trip Point.

For example, if the value set for Energy Trip Point is 888 and the value of the corresponding parameter at the moment this value is set is 1077, then the relay will trip after x sec of the moment the value of the parameter becomes 1965 (= 1077 + 888), where x is the ON Delay (see Section 3.2.5.1.1.2.8).

The value of Energy Trip Point can range from **10 to 9999999**.

NOTE : Default value is set to '10'.

Similarly, Limit - 2 and Limit - 3 parameters can be configured to trip the relay in a similar way to that of Limit - 1 (Given that one of the two Logic Operations (see Section .2.5.1.1.2.6) is active)

⚠ Caution: Once the relay has tripped, then to reactivate the Energy Tripping function, the user has to either reset the energy or re-enter the energy count.

3.2.5.1.1.2.6 Logic Operation Selection

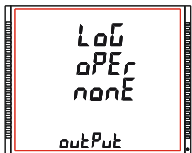

This screen is used to perform the logical operation between the three limit parameters. i.e. Limit - 1, Limit - 2 and Limit - 3.

User can perform any of the following operations using this screen :

- 1) **None** (To trip the relay based on only one limit parameter)
- 2) **AND** (To trip the relay when all the three limit parameters conditions are satisfied)
- 3) **OR** (To trip the relay when any one of the three limit parameters conditions are satisfied)

Pressing the " ▲ " key accepts the present value and advances to the "Relay Configuration" screen (see Section 3.2.5.1.1.2.7).

Pressing the " ▼ " key accepts the present value and advances to the :

i)"Limit - 1 setting screens (see Section 3.2.5.1.1.2.1 to Section 3.2.5.1.1.2.5) in case of logical operation is set as "None" (see Section 3.2.5.1.1.2.6).

OR

ii)"Limit - 3 setting screens (see Section 3.2.5.1.1.2.1 to Section 3.2.5.1.1.2.5) in case of logical operation is set as other than "None" (see Section 3.2.5.1.1.2.6).

Pressing the " ◀ " key advances to Logic Operation edit mode.

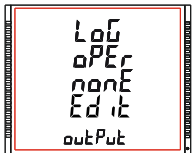

Pressing " ▲ " and " ▼ " keys scrolls through the options available.

- 1)None
- 2)AND
- 3)OR

Pressing the " ◀ " key sets the displayed value and advances to "Logic Operation" Screen (see Section 3.2.5.1.1.2.6).

Note : (1) **Default Selection is set to 'None'**.

(2) Limit Output Parameter Screens (see Section 3.2.5.1.1.2.1) for **Limit - 2** and **Limit - 3** are displayed or configured only when logic operation screen (see Section 3.2.5.1.1.2.6) is set as **AND** or **OR** .

3.2.5.1.1.2.7 Relay Configuration

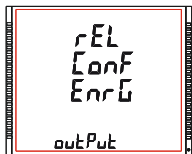

This screen is used to select one of the two configurations of relay for the selected limit output parameter. (see Section 3.2.5.1.1.2.1)

Pressing the "▲" key accepts the present selection and advances to the "ON Delay" screen (see section 3.2.5.1.1.2.8) and pressing the "▼" key accepts the present selection and advances to the "Logic Operation" screen (see section 3.2.5.1.1.2.6).

Relay Configuration Edit Mode

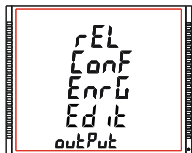

Pressing the "◀" key advances to Relay Configuration edit mode and "▲" and "▼" keys scrolls through the modes available.

EnrG (To Energize Relay)
d-Enr (To De-Energize Relay)

Note: Default configuration is set to 'EnrG'.

(For details refer to section 5.2)

Pressing the "◀" key sets the selected config. and advances to "Relay Configuration" menu screen (See section 3.2.5.1.1.2.7).

3.2.5.1.1.2.8 Limit Output ON Delay

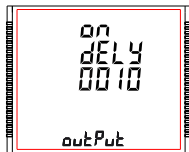

This screen allows the user to set ON Delay time in **seconds** for Relay Limit Assigned Parameter.

Pressing "▲" key accepts the present value and advance to "Limit Output OFF Delay" screen (see Section 3.2.5.1.1.2.9) and pressing "▼" key accepts the present value and advances to "Relay Configuration" screen (see Section 3.2.5.1.1.2.7).

ON Delay Edit Mode

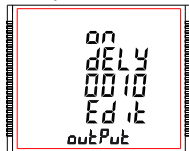

Press "←" key, prompt for the first digit.
Press the "▲" and "▼" keys to scroll the values of the first digit.
Press the "←" key to advance to next digit.

Similarly, enter second, third and fourth digits also.

After the fourth digit is entered, pressing "←" key sets the value and advances to "Limit Output ON Delay" screen (see Section 3.2.5.1.1.2.8).

The value of ON Delay can be set between **1 and 9999** seconds.

Note: Default value is set to '1' second.

3.2.5.1.1.2.9 Limit Output OFF Delay

This screen allows the user to set OFF Delay time in **seconds** for Relay Limit Assigned Parameters.



Pressing "▲" key accepts the present value and takes user to "Quit Limit Output" menu (See section 3.2.5.1.1.2.10).

Similarly, pressing "▼" key accepts the present value and takes user to "Limit Output ON Delay" menu (See section 3.2.5.1.1.2.8).

Pressing the "←" key advances to "OFF Delay" Edit mode.

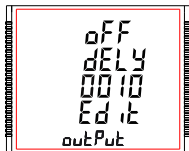

Pressing "←" key prompts for first digit.

Press the "▲" and "▼" key to scroll the value of the first digit.

Press the "←" key to advance to second digit.

The second digit prompts. Press "▲" and "▼" keys to scroll through 0 and 9 and "←" key to set the digit and advance to the third digit.

The third digit prompts. Press "▲" and "▼" keys to scroll through 0 and 9 and "←" key to set the digit and advance to the fourth digit.

Press "▲" and "▼" keys to scroll through 0 and 9.

Press "←" key to confirm the value and advance to "Limit Output OFF Delay" screen (see Section 3.2.5.1.1.2.9).

The value of OFF Delay can be set between **1 and 9999** seconds.

Note: Default value is set to '1' second.

3.2.5.1.1.2.10 Quit Limit Output

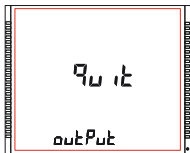

The screen allows user to exit the Relay output selection menu.

Pressing "▲" key advances to "Limit Output" menu (See section 3.2.5.1.1.2) and pressing "▼" key advances to "Limit Output OFF Delay" menu (see Section 3.2.5.1.1.2.9).

Pressing "◀" key advances to "Relay Selection" menu (see Section 3.2.5.1).

3.2.5.1.1.3.1 Number of Cycles

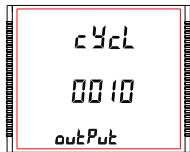

The value decides how many times the timer will repeat the switching after it has been started in the **timer based relay output option**.

Pressing "▲" key confirms the value and advances to the "Timer Configuration" menu (See section 3.2.5.1.1.3.2) and pressing "▼" key advances to "Timer" menu (See section 3.2.5.1.1.3).

The value for this **parameter can range from 0000 to 9999**.

If the value is set as 0000, the timer will keep repeating the cycles until 9999 cycles are complete or the timer is stopped by the user. Refer Section 5.3 for more details.

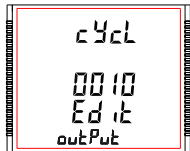

Press "◀" key, prompt for the first digit.

Press the "▲" and "▼" keys to scroll the values of the first digit.

Press the "◀" key to advance to next digit.

Similarly, enter second, third and fourth digits also.

After the fourth digit has been entered, pressing "◀" key sets the value and advances to "Number of Cycles" screen (see Section 3.2.5.1.1.3.1).

The default setting is '10' cycles.

3.2.5.1.1.3.2 Timer Configuration



The option decides the relay configuration for timer output. Two options are available:

1. **EnrG** : Energize on start
2. **d-Enr** : De-energize on start.

Pressing "▲" key confirms the selection and advances to the "On Delay" menu (See section 3.2.5.1.1.3.3) and pressing "▼" key advances to the "Number of Cycles" menu (See section 3.2.5.1.1.3.1).

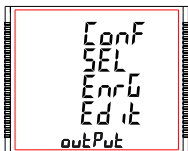

Press "←" key to enter the edit mode and press "▲" and "▼" keys to navigate between the options.

Pressing "←" key sets the selected config. and advances to the Timer Configuration menu (see Section 3.2.5.1.1.3.2).

Note : The default setting is 'EnrG'.

3.2.5.1.1.3.3 Timer On Delay

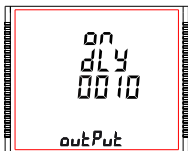

The value decides the time in seconds taken by the relay in timer configuration before tripping after it is started.

Pressing "▲" key confirms the value and advances to the "Off Delay" menu (See section 3.2.5.1.1.3.4) and pressing "▼" key advances to the "Timer Configuration" menu (See section 3.2.5.1.1.3.2).

Press "←" key, prompt for the first digit.

Press the "▲" and "▼" keys to scroll the values of the first digit.

ON Delay Edit Mode

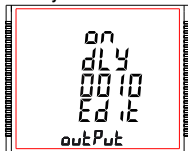

Press the "←" key to advance to next digit. Similarly, enter second, third and fourth digits also. After the fourth digit is entered, pressing "←" key sets the value and advances to "On Delay" screen (see Section 3.2.5.1.1.3.3).

The value for this parameter can range from 0001 to 9999 seconds.

Note : The default value is '10' seconds.

3.2.5.1.1.3.4 Timer Off Delay

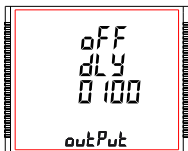

The value decides the time in seconds taken by the relay in timer configuration before coming out of the trip state after it has tripped.

Pressing "▲" key confirms the value and advances to the "Quit Timer Output" menu (See section 3.2.5.1.1.3.5) and pressing "▼" key advances to the "On Delay" menu (See section 3.2.5.1.1.3.3).

Press "←" key, prompt for the first digit.

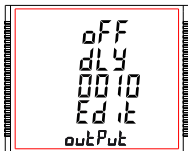

Press the "▲" and "▼" keys to scroll the values of the first digit. Press the "←" key to advance to next digit.

Similarly, enter second, third and fourth digits also. After the fourth digit has been entered, pressing "←" key sets the value and advances to Off Delay screen (see Section 3.2.5.1.1.3.4).

The value for this parameter can range from 0001 to 9999 seconds.

Note : The default value is '10' seconds.

3.2.5.1.1.3.5 Quit Timer Output

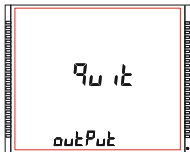

The screen allows user to exit the Timer output menu.

Pressing "▲" key advances to the "Timer Output" menu (see Section 3.2.5.1.1.3) and pressing "▼" key advances to "Off Delay" menu (see Section 3.2.5.1.1.3.4).

Pressing "◀" key advances to "Relay Selection" menu (see Section 3.2.5.1).

3.2.5.1.1.4.1 Load Health Monitor Configuration

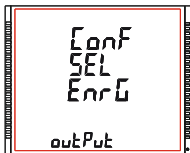

The option decides the relay configuration for Load Health Monitor output.

Two options are available:

1. **EnrG** : Energize on fault
2. **d-Enr** : De-energize on fault.

Pressing "▲" key confirms the selection and advances to the "Quit" screen menu for selected relay and pressing "▼" key advances to the "Load Health Output" menu (See section 3.2.5.1.1.4).

Relay Configuration Edit Mode

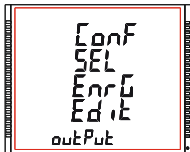

Press "◀" key to enter the edit mode and press "▲" and "▼" keys to navigate between the options.

Pressing "◀" key sets the selected config. and advances to the "Load Health Monitor" Configuration menu (see Section 3.2.5.1.1.4.1).

Note : The default setting is 'EnrG'.

3.2.5.1.1.5.Pre paid Energy Configuration

3.2.5.1.1.5.1 Parameter Selection

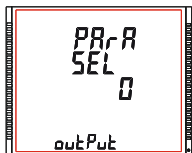

This screen allows user to assign energy parameters as per **TABLE 2.1** for **Pre-Paid Energy output**. Pressing "▲" key accepts the present setting and advance to "Unit Cost" (see section 3.2.5.1.1.5.2) selection & pressing "▼" key accepts the present setting and advance to "Pre-Paid Energy Output" menu (see section 3.2.5.1.1.5).

Parameter Selection Edit mode

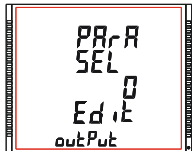

Pressing the "◀" key advances to edit mode and "▲" and "▼" keys scrolls through the energy parameters as per **TABLE 2.1**

Pressing the "◀" key sets the value & gives the "Parameter Selection" menu (see section 3.2.5.1.1.5.1).

NOTE: Default configuration is set as '0'.

3.2.5.1.1.5.2 Unit Cost

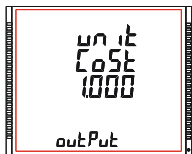

This screen allows the user to assign unit cost (i.e. cost per kilo) for the selected energy parameter.

Pressing "▲" key accepts the present setting and advance to "Top up recharge" (see section 3.2.5.1.1.5.3) screen and pressing "▼" key accepts the present setting and advance to "Parameter Selection" (see section 3.2.5.1.1.5.1) screen.

Pressing the "◀" key advances to edit mode and "▲" and "▼" scrolls through the required cost.

Unit Cost Edit mode

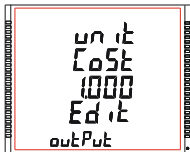

(Flashing decimal point indicates the cursor position). Initially the decimal point must be selected, pressing the "▲" or "▼" key moves the decimal point position to the right until it disappears, which means that it has reached ####. after which it returns to #.###.

Note: The absence of decimal point in edit mode implies ####. decimal point position.

Pressing the "◀" key accepts the present decimal point position and advances to first digit. Press the "▲" and "▼" keys through scroll the values of the first digit.

Press the "◀" key to advance to next digit. Similarly, enter second, third and fourth digits also. Unit cost ranges from 1 to 999.

Note: Default value is set to "1.000".

3.2.5.1.1.5.3 Topup Recharge



This screen allows the user to assign topup recharge for the energy parameter. Pressing "▲" key accepts the present setting and advance to "New recharge" screen (see section 3.2.5.1.1.5.4) and pressing "▼" key accepts the present setting and advance to "Unit cost" screen (see section 3.2.5.1.1.5.2).

Pressing the "◀" key advances to edit mode and "▲" and "▼" keys scrolls through the required topup recharge.

Topup Recharge Edit mode



Pressing the "←" key advances to the first digit position. Press the "▲" and "▼" keys to scroll the values of the first digit.

Press the "←" key to advance to next digit. Similarly, enter second, third until seventh digit.

Note: Default value is set to "100".

Note: Topup recharge range depends on Energy resolution unit(see Section 3.2.1.11)

1. When Energy resolution is "1", then topup recharge range will be from 1 to 9999.
2. When Energy resolution is "2 or 3", then topup recharge range will be from 1 to 999999.

3.2.5.1.1.5.4 New Recharge

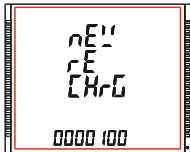

This screen allows the user to assign New recharge for the energy parameter. Pressing "▲" key accepts the present setting and advance to "quit" screen (see section 3.2.5.1.1.5.5) and pressing "▼" key accepts the present setting and advance to "Topup recharge" screen (see section 3.2.5.1.1.5.3).

Pressing the "←" key advances to edit mode and "▲" and "▼" keys scrolls through the required New recharge.

Unit Cost Edit mode

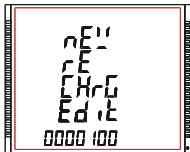

Pressing the "←" key advances to the first digit position. Press the "▲" and "▼" keys to scroll the values of the first digit.

Press the "←" key to advance to next digit. Similarly, enter second, third until seventh digit.

Note: Default value is set to "100".

Note: Topup recharge range depends on Energy resolution unit(see Section 3.2.1.11)

1. When Energy resolution is "1", then topup recharge range will be from 1 to 9999.
2. When Energy resolution is "2 or 3", then topup recharge range will be from 1 to 9999999.

3.2.5.1.1.5.5 Quit Pre Paid Energy Output

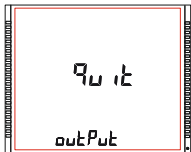

The screen allows user to exit the Pre Paid Energy output menu.

Pressing "▲" key advances to the "Pre Paid Energy Output" menu (see Section 3.2.5.1.1.5) and pressing "▼" key advances to "New Recharge" menu (see Section 3.2.5.1.1.5.4).

Pressing "◀" key advances to "Relay Selection" menu (see Section 3.2.5.1).

3.2.5.1.1.6 RTC Relay

3.2.5.1.1.6.1 Weekdays Selection

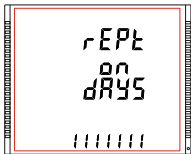

This screen allows the user to assign New weekday selection setting for the RTC Relay. Pressing "▲" key accepts the present setting and advance to "relay configuration" screen (see section 3.2.5.1.1.6.2) and pressing "▼" key accepts the present setting and advance to "RTC relay setting" screen (see section 3.2.5.1.1.6).

Pressing the "◀" key advances to edit mode and "▲" and "▼" keys scrolls through the required weekday selection.

Weekdays Edit mode



Pressing the "◀" key advances to the first digit position. Press the "▲" and "▼" keys to scroll the values of the first digit.

Press the "◀" key to advance to next digit. Similarly, enter second, third until seventh digit.

Note: Default value is set to "1111111".

3.2.5.1.1.6.2 Relay Configuration

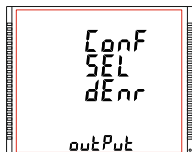

This screen allows the user to assign New relay configuration selection setting for the relay. Pressing "▲" key accepts the present setting and advance to "on time" screen (see section 3.2.5.1.1.6.3) and pressing "▼" key accepts the present setting and advance to "Weekday selection setting" screen (see section 3.2.5.1.1.6.1).

Pressing the "◀" key advances to edit mode and "▲" and "▼" keys scrolls through the required relay configuration selection.

Relay Configuration Edit mode

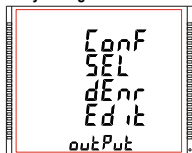

Pressing the "◀" key advances to the setting between Energized and De-energized. Press the "▲" and "▼" keys to scroll the setting for relay configuration.

Press the "◀" key to set the new setting for relay configuration..

Note: Default value is set to "Energized".

3.2.5.1.1.6.3 On Time

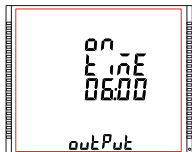

This screen allows the user to assign New on time selection setting for the relay. Pressing "▲" key accepts the present setting and advance to "off time" screen (see section 3.2.5.1.1.6.4) and pressing "▼" key accepts the present setting and advance to "Relay configuration setting" screen (see section 3.2.5.1.1.6.2).

Pressing the "◀" key advances to edit mode and "▲" and "▼" keys scrolls through the required on time.

On Time Edit mode

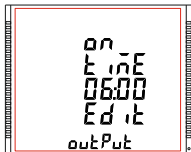

Pressing the "←" key advances to the new on time setting. Press the "▲" and "▼" keys to scroll the on time setting .

Press the "↵" key to set the new setting for relay on time.

Note: Default value is set to "06:00 hrs".

3.2.5.1.1.6.4 Off Time



This screen allows the user to assign New off time selection setting for the relay. Pressing "▲" key accepts the present setting and advance to "quit" screen (see section 3.2.5.1.1.6.5) and pressing "▼" key accepts the present setting and advance to "On time selection" screen (see section 3.2.5.1.1.6.4).

Pressing the "↵" key advances to edit mode and "▲" and "▼" keys scrolls through the required off time.

Off Time Edit mode

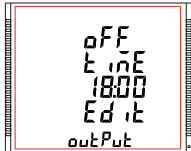

Pressing the "←" key advances to the new off time setting. Press the "▲" and "▼" keys to scroll the off time setting .

Press the "↵" key to set the new setting for relay off time.

Note: Default value is set to "18:00 hrs".

3.2.5.1.1.6.5 Quit RTC Output

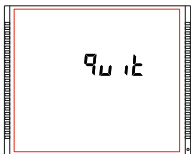

The screen allows user to exit the RTC Output menu.

Pressing "▲" key advances to the "RTC Relay" menu (see Section 3.2.5.1.1.6) and pressing "▼" key advances to "Off time" menu (see Section 3.2.5.1.1.6.4).

Pressing "◀" key advances to "Relay Selection" menu (see Section 3.2.5.1).

3.2.6 Load Health Parameter Selection

3.2.6.1 Unbalance Voltage Limit



This screen allows the user to set Trip point for instruments when the voltage is unbalance.

Pressing "▲" key accept the present value and advances to "Unbalance current limit" screen (see Section 3.2.6.2). Pressing "▼" key advances to "Quit Load Health" screen (see Section 3.2.6.7).

Pressing "◀" key advances to Edit mode.

Edit mode



(Flashing decimal point indicates the cursor position). Initially the "decimal point must be selected, pressing the "▲" or "▼" key moves the decimal point position to the right & left respectively until it disappears, which means that it has reached #####. after which it returns to #.### or ###.#

Pressing the "◀" key accepts the present decimal point position and advances to first digit. Press the "▲" and "▼" keys to scroll the values of the first digit.

Press the "▲" key to advance to next digit. Similarly, enter second, third and fourth digits also. **Value ranges from 5% to 20%**

Note: Default value is set to 20%.

3.2.6.2 Unbalance Current Limit



This screen allows the user to set Trip point for instrument, when the Current is unbalance.

Pressing "▲" key accept the present value and advances to "Under Frequency limit" screen (see Section 3.2.6.3). Pressing "▼" key advances to "Unbalance voltage limit" screen (see Section 3.2.6.1).

Pressing "←" key advances to Edit mode.

Edit mode



(Flashing decimal point indicates the cursor position). Initially the "decimal point must be selected, pressing the "▲" or "▼" key moves the decimal point position to the right & left respectively until it disappears, which means that it has reached #####. after which it returns to #.### or ###.#

Pressing the "←" key accepts the present decimal point position and advances to first digit. Press the "▲" and "▼" keys to scroll the values of the first digit.

Press the "←" key to advance to next digit. Similarly, enter second, third and fourth digits also. **Value ranges from 5% to 20%**

Note: (1) Default value is set to 20%.

(2) Setting Values as "0000" will disable this function.

3.2.6.3 Under Frequency Limit



This screen allows the user to set Trip point for instruments when the system frequency is under the tripping point.

Pressing "▲" key accept the present value and advances to "Under voltage limit" screen (see Section 3.2.6.4). Pressing "▼" key advances to "Unbalance Current limit" screen (see Section 3.2.6.2).

Pressing "←" key advances to Edit mode.

Edit mode



(Flashing decimal point indicates the cursor position). Initially the decimal point must be selected, pressing the "▲" or "▼" key moves the decimal point position to the right & left respectively until it disappears, which means that it has reached #####. after which it returns to #.### or ###.#

Pressing the "←" key accepts the present decimal point position and advances to first digit. Press the "▲" and "▼" keys to scroll the values of the first digit.

Press the "←" key to advance to next digit. Similarly, enter second, third and fourth digits also. **Value ranges from 95% to 99%**

Note: (1) Default value is set to 95%.

(2) Setting Values as "0000" will disable this function.

3.2.6.4 Under Voltage Limit



This screen allows the user to set Trip point for instruments when the voltage is under the tripping point.

Pressing "▲" key accept the present value and advances to "Over voltage limit" screen (see Section 3.2.6.5). Pressing "▼" key advances to "Under frequency limit" screen (see Section 3.2.6.3).

Pressing "←" key advances to Edit mode.

Edit mode

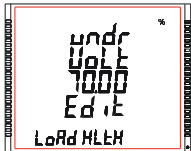

(Flashing decimal point indicates the cursor position). Initially the decimal point must be selected, pressing the "▲" or "▼" key moves the decimal point position to the right & left respectively until it disappears, which means that it has reached #####. after which it returns to #.### or ###.#

Pressing the "←" key accepts the present decimal point position and advances to first digit. Press the "▲" and "▼" keys to scroll the values of the first digit.

Press the "←" key to advance to next digit. Similarly, enter second, third and fourth digits also. **Value ranges from 70% to 90%**

Note: (1) Default value is set to 70%.

(2) Setting Values as "0000" will disable this function.

3.2.6.5 Over Voltage Limit



This screen allows the user to set Trip point for instruments when the voltage is above the tripping point.

Pressing "▲" key accept the present value and advances to "Over current limit" screen (see Section 3.2.6.6). Pressing "▼" key advances to "Under voltage limit" screen (see Section 3.2.6.4).

Pressing "←" key advances to Edit mode.

Edit mode



(Flashing decimal point indicates the cursor position). Initially the "decimal point must be selected, pressing the "▲" or "▼" key moves the decimal point position to the right & left respectively until it disappears, which means that it has reached #####. after which it returns to #.### or ###.#

Pressing the "←" key accepts the present decimal point position and advances to first digit. Press the "▲" and "▼" keys to scroll the values of the first digit.

Press the "→" key to advance to next digit. Similarly, enter second, third and fourth digits also. **Value ranges from 110% to 120%**

Note: (1) Default value is set to 120%.

(2) Setting Values as "0000" will disable this function.

3.2.6.6 Over Current Limit



This screen allows the user to set Trip point for instruments when the nominal current of system is above the tripping point.

Pressing "▲" key accept the present value and advances to "Quit Load Health" screen (see Section 3.2.6.7). Pressing "▼" key advances to "Over Voltage limit" screen (see Section 3.2.6.5).

Pressing "←" key advances to Edit mode.

Edit mode

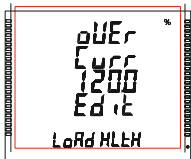

(Flashing decimal point indicates the cursor position). Initially the decimal point must be selected, pressing the "▲" or "▼" key moves the decimal point position to the right & left respectively until it disappears, which means that it has reached #####. after which it returns to #.### or ###.#.

Pressing the "←" key accepts the present decimal point position and advances to first digit. Press the "▲" and "▼" keys to scroll the values of the first digit.

Press the "←" key to advance to next digit. Similarly, enter second, third and fourth digits also. **Value ranges from 50% to 120%**

Note: (1) Default value is set to 120%.

(2) Setting Values as "0000" will disable this function.

3.2.6.7 Quit Load Health

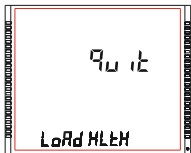

The screen allows user to exit the Load Health Parameter menu.

Pressing "▲" key advances to the "Unbalance Voltage limit" screen (see Section 3.2.6.1) and pressing "▼" key advances to the "Over current limit" screen (see Section 3.2.6.6).

Pressing "←" key advances to the "Load health Parameter" menu (see Section 3.2.6).

3.2.7 Digital Input Parameter Selection

3.2.7.1 De-Bounce Time

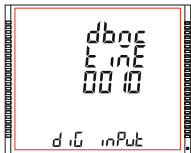

The screen allows user to set the De-bounce time for the digital inputs. When selected in Pulse mode, debounce time is the minimum time period for which the pulse should be high in order to be considered as a valid pulse. This setting is done in milliseconds.

Pressing "▲" key advances to the "Digital Input 1 Mode Selection" (see Section 3.2.7.2) and pressing "▼" key advances to the "Quit Digital Input" screen (see Section 3.2.7.6).

Pressing "←" key advances to the edit mode.

Note : Default value is set to "0010" milliseconds

Edit mode

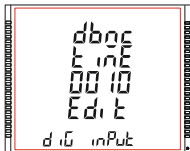

Pressing the "←" key prompts for the first digit.

Pressing the "▲" and "▼" keys scroll the values of the first digit.

Similarly, enter second, third and fourth digits also.

After the fourth digit is entered, pressing "←" key sets the value and advances to "De-bounce time" menu screen (see Section 3.2.7.1).

3.2.7.2 Digital Input 1 Mode Selection

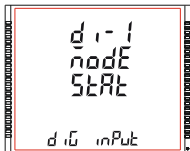

This screen allows the user to set the digital input in one of the three modes.

- 1) Status
- 2) Tariff*
- 3) Pulse

Pressing the "▲" key advances to "Digital input 1 pulse multiplier" screen (see Section 3.2.7.3) when **pulse** mode is selected and to "Digital Input 2 Mode Selection" screen (see Section 3.2.7.4) when other than **pulse** mode is selected. Pressing the "▼" key advances to "De-bounce Time" Selection Screen (see Section 3.2.7.1)

Pressing the "←" key advances to Edit Mode.

***Note : When digital inputs are selected in Tariff Mode, then TABLE 4 indicates the relationship between DI and Tariff.**

Edit mode

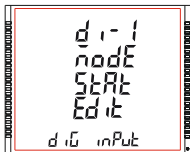

Pressing the "▲" and "▼" keys lets the user scroll through the available options.

Pressing the "←" key confirms the selection & takes the user to the "Digital Input 1 Mode Selection" menu screen.(see Section 3.2.7.2)

Note : Default configuration is set to "status".

3.2.7.3 Digital Input 1 Pulse Multiplier

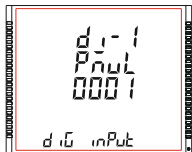

The screen allows user to set the values of the Digital Input 1 Pulse Multiplier.

Pressing "▲" key advances to the "Digital Input 2 Mode Selection" (see Section 3.2.7.4) and pressing "▼" key advances to the "Digital Input 2 Mode Selection" screen (see Section 3.2.7.2).

Edit mode



Pressing the "←" key prompts for the first digit.

Pressing the "▲" and "▼" keys scroll the values of the first digit.

Pressing the "→" key advances to the next digit.

Similarly, enter third and fourth digits also.

After the fourth digit is entered, pressing "←" key sets the value and advances to "Digital Input 1 Pulse Multiplier" menu screen. (see Section 3.2.7.3)

Note : Default value is set to '0001'.

3.2.7.4 Digital Input 2 Mode Selection

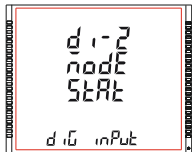

This screen allows the user to set the digital input in one of the two modes.

1) Status 2) Pulse

Pressing the "▲" key advances to "Digital input 2 pulse multiplier"(see Section 3.2.7.5) when **pulse** mode is selected and to "Quit Screen" (see Section 3.2.7.6) when other than **pulse** mode is selected.

Pressing the "▼" key advances to "Digital Input 1 Pulse Multiplier" Screen (see Section 3.2.7.3) when pulse mode is selected and to Digital Input 1 Mode Selection Screen (see Section 3.2.7.2) when other than pulse mode is selected.

Pressing the "←" key advances to Edit Mode.

Edit mode

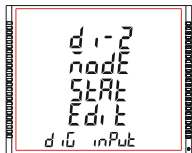

Pressing the "▲" and "▼" keys lets the user scroll through the available options.

Pressing the "←" key confirms the selection and takes the user to the Digital Input 2 Mode Selection Menu. (see Section 3.2.7.4)

Note : Default configuration is set to "status"

3.2.7.5 Digital Input 2 Pulse Multiplier

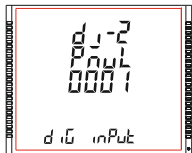

The screen allows user to set the values of the Digital Input 2 Pulse Multiplier.

Pressing "▲" key advances to the "Digital Input 3 Mode Selection" Screen (see Section 3.2.7.6) and pressing "▼" key advances to the "Digital Input 2 Mode Selection" screen (see Section 3.2.7.4).

Edit mode

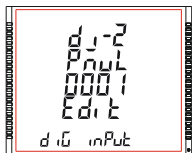

Pressing the "←" key prompts for the first digit.
Pressing the "▲" and "▼" keys scroll the values of the first digit.
Pressing the "←" key prompts for the next digit.

Similarly, enter third and fourth digits also.

After the fourth digit is entered, pressing "←" key sets the value and advances to "Digital Input 2 Pulse Multiplier" Menu. (see Section 3.2.7.5)

Note : Default value is set to '0001'.

3.2.7.10 Quit Digital Input

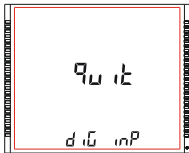

Pressing the "◀" key takes the user out of the Digital Input Selection Screen and advances to the Digital Input Menu. (see Section 3.2.7)

Pressing "▲" key advances to the "De-bounce Time" Selection Screen (see Section 3.2.7.1) and pressing "▼" key advances to the "Digital Input 4 Mode Selection" setting screens (see Section 3.2.7.8 & Section 3.2.7.9).

3.2.8 Tariff Parameter Selection

3.2.8.1 Number of Tariff Selection

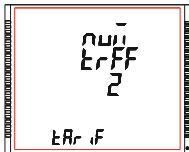

This screen allows the user to set multiple tariff (upto 2) on Digital Input 1, Digital Input 1.

Pressing the "▲" key advances to "Tariff Mode Selection" screen (see Section 3.2.8.2) and pressing the "▼" key advances to "Quit Tariff Parameters" Screen (see Section 3.2.8.4)

Pressing the "←" key advances to Number of Tariff Selection Edit Mode.

Edit mode

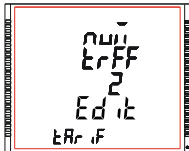

Pressing the "←" key prompts the shown digit and pressing "▲" "▼" keys lets the user scroll through the available options.

Pressing the "←" key confirms the selected value and advances to "Number of Tariff Selection" menu screen. (see Section 3.2.8.1)

3.2.8.2 Tariff Mode Selection

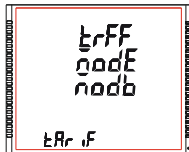

This screen allows the user to select the available tariff modes.

- 1)Modbus
- 2)Digital Input *
- 3)RTC

Pressing the "▲" key advances to "Tariff Energies Selection" screen (see Section 3.2.8.3) and pressing the "▼" key advances to "Number of Tariff Selection" screen (see Section 3.2.8.1)

Pressing the "←" key advances to Tariff Mode Selection Edit Mode.

Edit mode

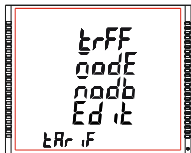

Pressing the "▲" and "▼" keys lets the user scroll through the available options.

Pressing the "←" key confirms the selected option and advances to "Tariff Mode Selection" menu screen. (see Section 3.2.8.2)

***NOTE :** The Digital Input Option can only be selected and shown when atleast "Digital Input 1" Mode (See section 3.2.7.2) is configured as Tariff. When only DI1 is configured as Tariff, then max 2 tariff can be selected (see section 3.2.8.1) whereas when DI1, DI2 and DI3 are configured as Tariff, then max 8 tariff can be selected. TABLE 4 indicates the relationship between DI and Tariff.

3.2.8.3 Tariff Energies Selection

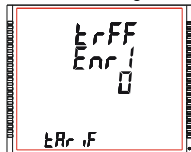

This screen allows the user to select first of the total six tariff energies.

Pressing the "▲" key advances to "Tariff Energy - 2" and pressing "▼" key advances to "tariff mode selection" menu. (see Section 3.2.8.2)

Pressing the "←" key advances to the edit mode and pressing the "▲" and "▼" keys lets the user select the energy parameter as per TABLE 2.1

Pressing the "←" key confirms the selected value and take the user out of the edit mode.

Note : Similarly User can select six different tariff energies.

3.2.8.4 Tariff RTC Start Time



This screen allows the user to set the start time of all the tariffs selected (see section 3.2.8.1) in RTC Mode (see section 3.2.8.2). The settable range is 0 to 235959.

Pressing the "▲" key advances to "Tariff Start time - 2" and pressing "▼" key advances to "tariff energy selection" menu. (see Section 3.2.8.3)

Pressing the "←" key advances to the edit mode and pressing the "▲" and "▼" keys lets the user select the parameter as per range given above.

Pressing the "↵" key confirms the selected value and take the user out of the edit mode.

Note : Similarly User can select maximum 8 different tariff start times.

3.2.8.5 Quit Tariff Parameters

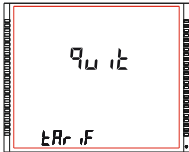

Pressing "▲" key advances to the "Number of Tariff" Selection Screen (see Section 3.2.8.1) and pressing "▼" key advances to the "Tariff RTC Start Time" screen (see Section 3.2.8.4).

Pressing the "←" key takes the user out of the Tariff Parameters Selection Screen and advances to the Tariff Parameter Menu Screen. (see Section 3.2.8)

3.2.9 Datalog Option Selection

3.2.9.1 Event Based Datalog Setup



This screen is used to enter into event datalogging feature.

Pressing the "▲" key advances to the "Time Based Datalog" menu (see Section 3.2.9.2) and pressing the "▼" key takes to the "Quit Datalog Option" menu (see Section 3.2.9.4).

Pressing the "◀" key advances to the Event Based datalog selection and pressing the "▲" and "▼" key scrolls through the options available:

datalog : YES/no (see Section 3.2.9.1.1)

quit : to exit Event Datalog Selection (see Section 3.2.9.1.2)

3.2.9.1.1 Event Based Datalog Selection

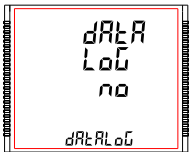

This screen is used to start or stop event datalogging.

Pressing the "◀" key allows the user to start or stop event based datalogging by selecting "YES" or "no", respectively using "▲" and "▼" keys.

Once the required option is selected, pressing the "◀" key sets the selection and advances to the Event Based Datalog selection screen (see Section 3.2.9.1.1).

3.2.9.1.2 Quit Event Datalog

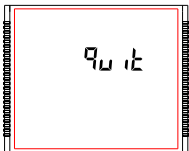

This screen is used to exit event based datalog selection.

Pressing the "◀" key advances to the Event Based Datalog setup screen (see Section 3.2.9.1).

3.2.9.2 Time Based Datalog Setup



This screen is used to enter into time based datalog feature.

Pressing the "▲" key takes to the "Load Profile Datalog" menu (see section 3.2.9.3) and pressing the "▼" key takes to the "Event Based Datalog" menu (see section 3.2.9.1).

Pressing the "◀" key advances to Time Based datalog selection and pressing "▲" and "▼" keys scrolls through various parameters related to time based datalogging (see Section 3.2.9.2.1 to Section 3.2.9.2.5).

3.2.9.2.1 Time Based Datalog Selection

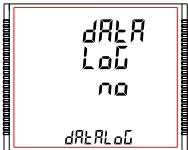

This screen is used to start or stop time based datalogging.

Pressing the "▲" key confirms the selection and advances to "Time Interval Selection" screen (see Section 3.2.9.2.2) and pressing the "▼" key confirms the selection and advances to "Quit Time Based Logging" screen (see Section 3.2.9.2.5).

Pressing the "◀" key allows the user to start or stop time based datalogging by selecting "YES" or "no", respectively using "▲" and "▼" keys.

Pressing the "◀" key sets the selection and if the selection is "YES", then "Pls Wait" screen appears followed by "Time Based Datalog Selection" screen (see Section 3.2.9.2.1).

⚠ Caution: The settings for time based logging (see Section 3.2.9.2.2 - Section 3.2.9.2.4) are not editable if time based datalog selection is set to YES (see Section 3.2.9.2.1).

3.2.9.2.2 Time Interval Selection

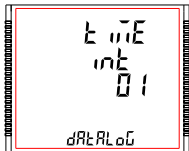

This screen is used to decide the time interval between two successive time datalog entries.

The allowable range is 01 - 60 minutes.

Pressing the "▲" key confirms the selection and advances to "Parameter Count" screen (see Section 3.2.9.2.3) and pressing the "▼" key confirms the selection and advances to "Time Based Datalog Selection" screen (see Section 3.2.9.2.1).

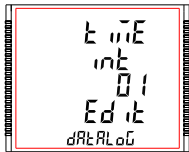

Press " " to enter different time interval, it prompts for first digit.

Press the "▲" and "▼" keys to scroll the value of the first digit. Press the "←" key to advance to next digit.

Similarly, enter the second digit of interval.

After entering second digit, pressing "←" key sets the value and advances to the "Time Interval Selection" screen (see Section 3.2.9.2.2).

The default value is '1' second.

3.2.9.2.3 Parameter Count

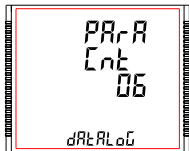

This screen is used to decide the number of parameters that will be logged in time based datalogging.

The allowable range is 01 - 60.

Pressing the "▲" key confirms the selection and advances to "Parameter Selection" screen (see Section 3.2.9.2.4) and pressing the "▼" key confirms the selection and advances to "Time Interval Selection" screen (see Section 3.2.9.2.2).

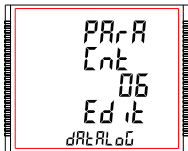

Press "←" to enter the parameter count, prompt for first digit.

Press the "▲" and "▼" keys to scroll the value of the first digit. Press the "←" key to advance to next digit.

Similarly, enter the second digit of interval. After entering second digit, pressing "←" key sets the value and advances to the "Parameter Count" screen (see Section 3.2.9.2.3).

The default value is '1'.

3.2.9.2.4 Parameter Selection

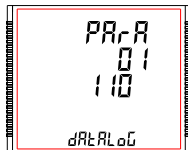

This screen is used to select the measurement parameters to be recorded. The allowable values are shown in Table 5.

For each of the parameter count set in Section 3.2.9.2.3, the corresponding parameter number (**Refer Table 5**) can be set by the user.

Pressing "▲" key confirms the selection and allows the user to proceed for setting the next parameter until the last parameter is set which is followed by the "Quit Time Based Datalog" screen (see Section 3.2.9.2.5).

Where as pressing the "▼" key confirms the selection and takes to the previous parameter set until the first parameter is reached which is followed by the "Parameter Count" screen (see Section 3.2.9.2.3).



Press "←" to enter the parameter selection.

Press the "▲" and "▼" keys to scroll the value of the measurement parameter number in decreasing and increasing order, respectively.

Pressing "←" key sets the value and take user to the "Parameter Selection" screen (see Section 3.2.9.2.4) for the parameter set.

The default value is '000', i.e. no parameter to be logged.

3.2.9.2.5 Quit Time Based Datalog

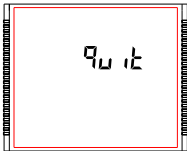

This screen is used to exit time based datalog selection.

Pressing the "◀" key advances to the "Time Based Datalog Setup" screen (see Section 3.2.9.2).

3.2.9.3 Load Profile Datalog Setup



This screen is used to enter into Load Profile datalog feature.

Pressing the "▲" key takes to the "Quit Datalog Option" menu (see Section 3.2.9.4) and pressing the "▼" key advances to "Time Based Datalog Setup" (see Section 3.2.9.2).

Pressing the "◀" key advances to the Load Profile datalog selection and pressing the "▲" and "▼" key scrolls through the options available:

datalog : YES/no (see Section 3.2.9.3.1)

quit : to exit Load Profile Datalog selection (see Section 3.2.9.3.2)

3.2.9.3.1 Load Profile Datalog Selection

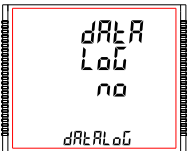

This screen is used to start or stop Load Profile datalogging.

Pressing the "◀" key allows the user to start or stop Load Profile datalogging by selecting "YES" or "no", respectively using "▲" and "▼" keys.

Pressing the "◀" key sets the selection and if the selection is "YES", then "Pls Wait" screen appears followed by "Load Profile Datalog Selection" screen (see Section 3.2.9.3.1). If the selection is "no", then "Pls Wait" screen does not appear.

⚠ Caution: If any setting is done by user which resets energy or demand parameter it will reset load profile data.

3.2.9.3.2 Quit Load Profile Datalog Selection

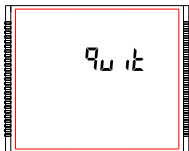

This screen is used to exit Load Profile datalog selection.

Pressing the "←" key advances to the "Load Profile Datalog Setup" screen (see Section 3.2.9.3).

3.2.9.4 Quit Datalog Option



The screen allows user to exit the Datalog Option menu.

Pressing "▲" key advances to the "Event Based Datalog" menu (see Section 3.2.9.1) and pressing "▼" key advances to the "Load Profile Datalog Setup" menu (see Section 3.2.9.3).

Pressing "←" key advances to the "Datalog Option Selection Menu" (see Section 3.2.9).

3.2.10 Display Parameter Selection

3.2.10.1 Feature Selection Menu



This menu allows the user to scroll through different Display Configurable features:

SEL bCLt PARa : backlit on/off

SEL Scrn Para : user screen on/off

SEL Cont Para : Contrast level

dISP tEst Scrn : LCD Display all symbols glow

quit : to exit Display Parameters screen

Pressing the "←" key advances to the listed features (see Section 3.2.10.1.1 to Section 3.2.10.1.5).

3.2.10.1.1 Backlit



This screen allows the user to switch the backlight on or off.

Pressing the "▲" and "▼" keys advances to "User Assignable Screens" (see Section 3.2.10.1.2) and "Quit Display Parameters" menu (see Section 3.2.10.1.5), respectively.

Pressing the "◀" key takes the user into edit mode.

Backlit Edit Mode

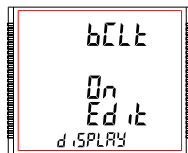

In Edit Mode, pressing "▲" and "▼" keys allows the user to scroll between On/OFF and pressing "◀" key confirms the selection.

Pressing "◀" key again advances to editing mode whereas pressing "▲" or "▼" keys advances to "Feature Selection" menu screen (see Section 3.2.10.1.1).

- Note:** (1) Default value is set to 'On'.
(2) When backlight is switched 'Off', on pressing any key backlight will turn 'On' for 1 min.

3.2.10.1.2 User Assignable Screens



This screen allows the user to enable or disable the User Screen feature.

Using this feature, the user can select upto 10 measurement screens of choice and scroll through only those selected screens.

Pressing the "◀" key allows the user to advance to the "Screen Number Selection" menu (see Section 3.2.10.1.2.1) whereas pressing the "▼" and "▲" keys advances to "Backlit" menu screen (see Section 3.2.10.1.1) and "Contrast" menu screen (see Section 3.2.10.1.3), respectively.

3.2.10.1.2.1 Screen Number Selection



Pressing the "▲" key sets the present value for the number of screens to be shown and advance towards the "User Screens Selection" menu (see Section 3.2.10.1.2.2) whereas pressing the "▼" key sets the present value and advance to "Quit Userscreens" menu (see Section 3.2.10.1.2.3).

Pressing "◀" key allow the user to set a different value for the number of user assignable screens using "▲" and "▼" keys.

The user can set the number of screens from **1 to 10**.

User Screen Edit Mode

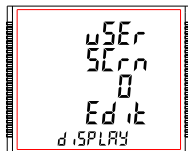

Pressing "◀" key sets the selected value and advances to "Screen Number Selection" screen (see Section 3.2.10.1.2.1).

Note: 1.The value 0 should be chosen if the user wants all the screens to be shown.

2. If User Screen feature is ON and System type is changed, then the Userscreen is disabled.

Note : The default setting is '0', i.e., all screens are shown.

Note : User needs to put the combination of key number and screen number at this screen. Refer TABLE 1 for screen number. For example, to select screen number 3 of 'V/A key' (key number 1), assign 103 to the corresponding screen number. Similarly, 'P key' and 'Sys key' have key number 2 and 3, respectively.

3.2.10.1.2.2 User Screens Selection

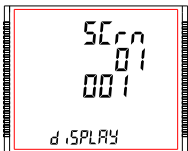

Pressing the "▲" key confirms the selection and allows the user to proceed for setting the next userscreen until the last userscreen is set which is followed by the "Quit UserScreens" menu (see Section 3.2.10.1.2.3).

Whereas pressing the "▼" key confirms the selection and take to the previous userscreen set until the first userscreen is reached which is followed by the "Screen Number Selection" screen (see Section 3.2.10.1.2.1).

User Screen Selection Edit Mode

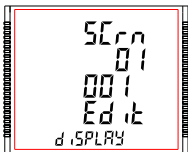

Pressing the "←" key advances the User Screen Edit mode and pressing "▲" and "▼" keys scroll the value as per **TABLE 1.1**, **TABLE 1.3**, **TABLE 1.4**.

Pressing "↵" key sets the displayed value & advance to User Screen Selection (see Section 3.2.10.1.2.2) for the corresponding screen number.

3.2.10.1.2.3 Quit Userscreens

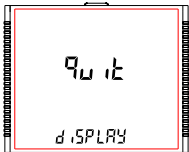

This screen is used to exit User defined Screen selection.

Pressing the "←" key advances to the "User Assignable Screens" menu (see Section 3.2.10.1.2).

3.2.10.1.3 Contrast



This screen allows the user to set the contrast for the display.

Pressing the "▲" and "▼" keys advances to "Display Test Screen" menu (see Section 3.2.10.1.4) and "User Assignable Screens" menu (see Section 3.2.10.1.2), respectively.

Pressing the "←" key shows the present contrast value and pressing "↵" key again will allow editing it whereas "▲" and "▼" keys advances to the "Contrast" menu (see Section 3.2.10.1.3).

Contrast Edit Mode



In Edit Mode, pressing "▲" and "▼" keys allows the user to scroll between **contrast levels ranging from 1 to 4** and pressing "◀" key confirms the selection.

Pressing "◀" key advances to editing mode whereas pressing "▲" or "▼" keys advances to the "Contrast" menu (see Section 3.2.10.1.3).

Note : Default value is set to '3'.

3.2.10.1.4 Display Test Screen

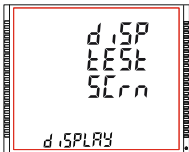

This screen allows the user to check if there is any fault in one of the symbols or segments on the LCD display by completely turning on the display.

Pressing "▲" and "▼" key advances to Quit Screen (see Section 3.2.10.5) and Contrast Screen (see Section 3.2.10.3) respectively.

Whereas pressing "◀" key advances to the All ON Display.

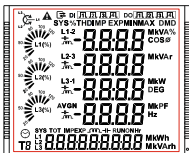

In All ON mode pressing "▲" or "▼" key takes the user back to "Display Test" (see Section 3.2.10.1.4) menu screen.

3.2.10.1.5 Quit Display Parameters

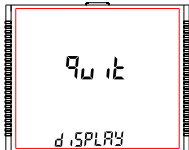

This screen allows user to Exit from Display Parameter Selection setup.

Pressing the "▲" key advances to "Select Backlit Para" screen. (see Section 3.2.10.1). Whereas pressing the "▼" key advances to "Display Test screen" screen. (see Section 3.2.10.1.4).

Pressing the "◀" key advances to "Display Parameter Selection" screen (see Section 3.2.10).

3.2.11 RTC Setting Screen

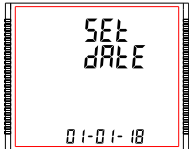

This screen allows the user to set date and time for the device RTC.

Pressing "◀" advances to Date Settings (see Section 3.2.11.1) and pressing "▲" and "▼" keys advances to Time Settings (see Section 3.2.11.2) and "Quit RTC" screen (see Section 3.2.11.3), respectively.

3.2.11.1 Date Settings

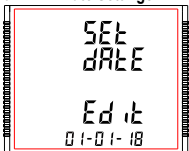

This screen allows the user to set the date for device RTC.

The date is displayed in DD-MM-YY format in the settings and its **range is 01-01-00 to 31-12-99** (for the 21st century, i.e., YY = 00 represents 2000 and YY = 99 represents 2099).

Press "◀", prompt for DD.

Press "◀", prompt for MM.

Press "◀", prompt for YY.

Keys "▲" and "▼" are used to change the values of DD, MM and YY. After YY is set, pressing "◀" advances to "Pls Wait" screen followed by "Date Settings" screen (see Section 3.2.11.1).

⚠ Caution : If date setting is changed then load profile log data will reset.

3.2.11.2 Time Settings

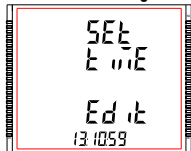

This screen allows the user to set the time for device RTC. The date is displayed in HH:MM:SS format in the settings and its **range is 00:00:00 to 23:59:59**.

Press "←", prompt for 10's place of HH.
Press "←", prompt for 1's place of HH.
Press "←", prompt for 10's place of MM.
Press "←", prompt for 1's place of MM.
Press "←", prompt for 1's place of SS
Press "←", prompt for 1's place of SS
Keys "▲" and "▼" are used to change the corresponding values.

After 1's place of SS is set, pressing "←" advances to "Time Settings" screen (see Section 3.2.11.2).

3.2.12.1 Factory Reset Selection

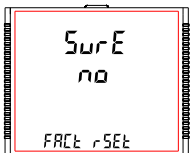

This screen allows the user to erase all data from the meter and set all setup parameters to their default values.

Pressing the "←" key advances to the "Sure" (confirmation) screen which displays a "no".
Pressing "▲" or "▼" key advances to Factory Reset Menu(see Section 3.2.12).

Whereas pressing "←" key advances to the Factory Reset selection screen.

Factory Reset Selection Screen

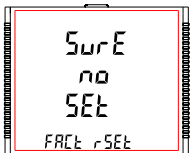

Pressing "▲" or "▼" key allows the user to select between "YES" or "no".

YES : Allow Factory Reset
no : Don't allow Factory Reset

Pressing "←" accepts the selection and if the selection is "YES", advances to "Pls Wait" screen followed by the "Sure" screen of "Factory Reset Screen" (see Section 3.2.12). If the selection is "no", then "Pls Wait" screen does not appear.

3.2.13 Setup Quit

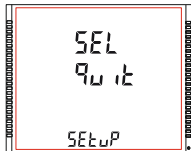

This screen allows the user to exit the setup menu.

Pressing the "▲" key advances to the System Parameter Selection (see Section 3.2.1) screen and pressing the "▼" key advances to the "Factory Reset" (see Section 3.2.12) menu.

Pressing "◀" key quits from the Setup menu and advance to measurement screen at which the setup screen was accessed.

4. Programmable unit format for Power and Voltage.

This device support programmable unit format for Power and Voltage, which is reflected only on MODBUS using particular addresses(refer RISH LM_1360+ Interface definition, section: **Explanation for 4X, pg 58**).

5. Energy Auto-Ranging On Display :

5.1 Calculating Display energy (Auto-ranging):

In case of energy auto-ranging the energy shown on modbus will be in terms of Overflow count (OF) & main energy counter (M) based on energy unit/resolution & energy digit reset count (EDRC). So energy on modbus will have unit set in energy resolution on modbus (ie. Wh or kWh or MWh) & overflow energy counter (OF) on modbus will increment when main energy counter (M) on modbus will cross the number of digits set in energy digit reset count (EDRC) register (i.e. 7 or 8 or 9).

Whereas energy shown on display will be Combined energy (ie. Calculated from overflow count (OF) on modbus & main energy Count (M) on modbus) auto ranged based on the 9 digits available on display to show energy.

Hence the purpose of this document is to establish a relation between modbus energy counters & display energy.

$$\text{Total Energy} = \text{OF} \times 10^{\text{EDRC}} + \text{M}$$

Where: OF => Overflow Count on modbus

e.g.

Modbus register for Overflow count (OF):

Wh import Overflow count => 30109 Or 40109

M => Main Energy Counter on modbus

e.g.

Modbus registers for Main energy Count (M):

Wh import => 30111 Or 40111

NOTE : Refer the interface definition manual of this product for modbus register addresses for energy parameters.

EDRC => Energy digit reset count set by user from display or modbus
For display setting refer Section 3.2.1.12.
For modbus refer Register 46023.

Example for Calculating Display Energy from modbus Energy Counters:

Energy unit/resolution on modbus register 46021 is set to 2 (ie. It will measure energy in kWh).

Overflow count (OF) value on modbus register 30109 for watt Import is 25.

Energy main counter (M) value on modbus register 30111 for watt import is 2587413.189

Energy digit reset count (EDRC) set by user in modbus register 46023 is 8.
Then,

$$\begin{aligned}\text{Total Energy} &= 25 \times 10^8 + 2587413.189 \\ &= 2500000000 + 2587413.189 \\ &= 2502587413.189 \text{ kWh}\end{aligned}$$

Therefore Energy shown on display will be:
= 2502587.41 MWh

As maximum number of digits for displaying energy present on display is 9 and the value of Total Energy in above example exceeds 9 counts so Energy in kWh is converted to MWh for displaying as shown above.

Note: As maximum energy shown on the display is XXXXXXXXX (9 Count) MWh so if count of above calculation for Total energy exceeds XXXXXXXXX (9 Count) MWh then the display will show "----oF--" with unit MWh that indicates display energy has overflowed. This condition will only get reset if the Total Energy Count gets reset.

Overflow count (OF) on modbus will reset to 0 if it exceeds 99999999 in case of Wh resolution, 99999 in case of kWh resolution & 99 in case of MWh resolution.

5.2 Entering Energy start count:

(Applicable for meter with modbus or Ethernet)

Energy start count is the feature that allows user to set count from which the meter should start incrementing energy. The start count can be set for main energy start counter & Overflow energy start Counter separately from modbus or Ethernet. Setting of energy start count is dependent on Energy resolution & Energy digit reset count (EDRC).

Energy unit/resolution on modbus can be set by user from display (See Section 3.2.1.11) or from modbus (refer modbus register 46021).

Value for Energy resolution can be set to Wh,kWh or MWh.

Minimum resolution of energy that can be set in energy start count register is, the Energy resolution set by user.

For Eg.: Energy start count can be set to minimum 1Wh if the value on modbus register 46021 is set to Wh Or Energy start count can be set to minimum 1MWh if the value on modbus register 46021 is set to MWh.

Maximum value that can be set in the main energy start count register is $(10^{(EDRC)}-1)$.

Where:

EDRC => Energy digit reset count set by user from display or modbus

For display setting refer Section 3.2.1.12.

For modbus refer Register 46023

Example for calculating maximum limit of main energy start count :

If EDRC is 7 then Maximum value that can be set in the main energy start count (M) register is

$$\begin{aligned} &= (10^{(EDRC)}-1) \\ &= ((10^7)-1) \\ &= (10000000-1) \\ &= 9999999 \end{aligned}$$

Similarly if EDRC is 8 the maximum value is 99999999 & if EDRC is 9 maximum value is 999999999.

Maximum value that can be set in the Overflow energy start count register is 99999999 for Wh renergy resolution ,99999 for kWh energy resolution ,99 for MWh resolution.

Note: Energy start Count can only be entered in integer value.

6. Relay Output (Optional) :

The Meter is provided with relay for pulse output, limit switch, Load health tripping, Pre-Paid Energy based tripping and as a Timer.

6.1 Pulse Output :

Pulse Output is the potential free, very fast acting relay contact which can be used to drive an external mechanical counter for energy measurement. The Pulse Output can be configured to the parameters maintained in TABLE 2.1 through setup parameter screen:

TABLE 2 : Pulse Output Tables

TABLE 2.1 : Parameters for Pulse Output

Parameter Number	Parameter	3P4W	3P 3W	1P 2W	1P 3W	2P 2W
0	Sys Wh import	✓	✓	✓	✓	✓
1	Sys Wh export	✓	✓	✓	✓	✓
2	Sys VARh import	✓	✓	✓	✓	✓
3	Sys VARh export	✓	✓	✓	✓	✓
4	Sys VAh	✓	✓	✓	✓	✓
6	Active Energy Import L1	✓	✗	✗	✓	✗
7	Active Energy Import L2	✓	✗	✗	✓	✗
8	Active Energy Import L3	✓	✗	✗	✗	✗
9	Active Energy Export L1	✓	✗	✗	✓	✗
10	Active Energy Export L2	✓	✗	✗	✓	✗
11	Active Energy Export L3	✓	✗	✗	✗	✗
12	Reactive Energy Capacitive L1	✓	✗	✗	✓	✗
13	Reactive Energy Capacitive L2	✓	✗	✗	✓	✗
14	Reactive Energy Capacitive L3	✓	✗	✗	✗	✗
15	Reactive Energy Inductive L1	✓	✗	✗	✓	✗
16	Reactive Energy Inductive L2	✓	✗	✗	✓	✗
17	Reactive Energy Inductive L3	✓	✗	✗	✗	✗
18	Apparent Energy L1	✓	✗	✗	✓	✗
19	Apparent Energy L2	✓	✗	✗	✓	✗
20	Apparent Energy L3	✓	✗	✗	✗	✗
24	Total Sys Active Energy	✓	✓	✓	✓	✓
25	Total Sys Reactive Energy	✓	✓	✓	✓	✓

TABLE 2.1 : Continued...

Parameter Number	Parameter	3P4W	3P 3W	1P 2W	1P 3W	2P 2W
26	Total Sys Apparent Energy	✓	✓	✓	✓	✓
27	Total Active Energy L1	✓	✗	✗	✓	✗
28	Total Active Energy L2	✓	✗	✗	✓	✗
29	Total Active Energy L3	✓	✗	✗	✗	✗
30	Total Reactive Energy L1	✓	✗	✗	✓	✗
31	Total Reactive Energy L2	✓	✗	✗	✓	✗
32	Total Reactive Energy L3	✓	✗	✗	✗	✗

TABLE 2.2 : Energy Pulse Rate Divisor

1.For Energy Output in Whr

Divisor	Pulse rate	
	Pulse	System Power*
	1 per Whr	Up to 3600 W
1	1 per kWhr	Up to 3600 kW
	1 per MWhr	Above 3600 kW up to 30000 kW
	1 per 10Whr	Up to 3600 W
10	1 per 10kWhr	Up to 3600 kW
	1 per 10MWhr	Above 3600 kW up to 30000 kW
100	1 per 100Whr	Up to 3600 W
	1 per 100kWhr	Up to 3600 kW
	1 per 100MWhr	Above 3600 kW up to 30000 kW
1000	1 per 1000Whr	Up to 3600 W
	1 per 1000kWhr	Up to 3600 kW
	1 per 1000MWhr	Above 3600 kW up to 30000 kW
Pulse Duration 60 ms, 100 ms or 200 ms		

2.For Energy Output in kWhr

Divisor	Pulse rate	
	Pulse	System Power*
1	1 per kWhr	Up to 3600 kW
	1 per MWhr	Above 3600 kW

3.For Energy Output in MWhr

Divisor	Pulse rate	
	Divisor	Pulse
1	1	1 per MWhr

Above options are also applicable for Apparent and Reactive Energy.

*Note:

- 1) System power = 3 x CT(Primary) x PT (Primary) L-N for 3 Phase 4 Wire
- 2) System power = Root3 x CT(Primary) x PT (Primary)L-L for 3 Phase 3 Wire & 2 Phase 2 Wire
- 3) System power = CT(Primary) x PT(Primary)L-N for 1 Phase 2 Wire
- 4) System power = 2xCT(Primary) x PT(Primary)L-N for 1 Phase 3 Wire

6.2 Limit Switch :

Limit switch can be used to monitor upto three measured parameter (refer **TABLE 3**) with either ANDing/ORing or no logic for tripping in relation with to a set limit.

The limit switch can be configured for Alarm-High or Alarm-Low, settable for each parameter and Energized or de-Energized for the relay. The trip point, hysteresis, energizing delay and de-energizing delay are user-selectable.

High Alarm:

If Alarm - High and Relay - Energized or Alarm - High and Relay - De-Energized combination is configured then relay will get Energized or De-energized, when selected parameter is greater than or equal to trip point.

Low Alarm:

If Alarm - Low and Relay - Energized or Alarm - Low and Relay - De-Energized combination is configured then relay will get Energized or De-energized, when selected parameter is less than or equal to trip point.

Note: For Alarm-Low configuration, set the values of trip point & hysteresis such that % trip point + % hysteresis should be less than 100% Value.

Example for Phase angle:

If trip point is set 70% then maximum applicable hysteresis is 42.8%. i.e Trip point 70% (252°) + Hysteresis 42.8% (107.8°) = 359.8° If total value is greater than the 100% i.e. 360° then relay will not release.

Example for PF:

For Alarm - High and Relay - Energized combination, if trip point is 70% & hysteresis is 30%, then trip value = $0.7 \times 90^\circ = 63^\circ$. Tripping PF = $\cos(63^\circ) = 0.4539$ & hysteresis = $0.3 \times 0.4539 = 0.136$.

Hence, the relay will energize above 0.4539 and de-energize below 0.3179.

Note: This function will work irrespective of +/- sign. It depends only on value.

Trip point:

Trip point can be set in the range as specified in **TABLE 3** of nominal value for Alarm - High & 10% to 100 % of nominal value for Alarm - Low.

Hysteresis:

Hysteresis can be set in the range of 0.5% to 50 % of set trip point. If Alarm - High & Relay - Energized or Alarm - High & Relay - De-Energized combination is selected then relay will get Energized or De-energized respectively, if set parameter value is less than Hysteresis. Similarly for the combinations of Alarm - Low & Relay - Energized or Alarm - Low & Relay - De-Energized.

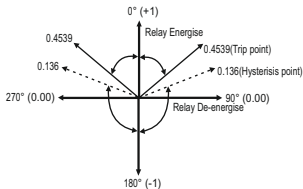

Note : In case of Alarm - Low if trip point is set greater than 80% then the maximum hysteresis can be set such that the total Trip point+ Hysteresis(% of trip point value) will not exceed 120% of range.

For example :If trip point is set at 90%, then maximum 33.3% hysteresis should be set such that, $[90 + 29.99 (33.3\% \text{ of } 90)] = 120$.

ON Delay:

The ON delay can be set in the range from 1 to 9999 seconds to Energize the Relay.

OFF Delay:

The OFF delay can be set in the range from 1 to 9999 seconds to De-energize the Relay.

Logic Operation:

Relay can be operated for ANDing or ORing of upto three parameters listed in TABLE 3, e.g., Watt Sum, Frequency and PF can be Ored on the single relay with separate settings of these parameters.

Examples of different configurations

Parameter No. 4 (Current1)

Trip Point = 50%

Hysteresis = 50% of trip point

ON Delay: 2 sec

OFF Delay: 2 sec

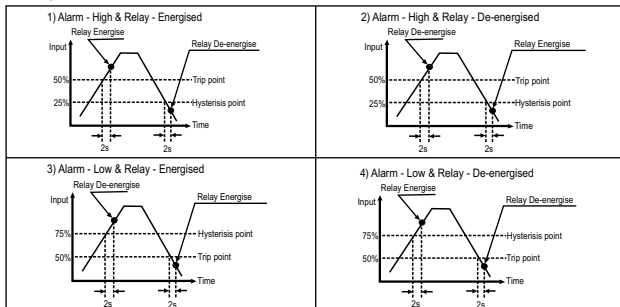

TABLE 3 : Parameters for Limit output

Parameter Number	Parameter	3P 4W	3P 3W	1P 2W	1P 3W	2P 2W	Trip Point Set Range	100% Value
0	None	✓	✓	✓	✓	✓	-	-
1	Volts 1	✓	✓	✓	✓	✓	10 - 120 %	Vnom (L-N)
2	Volts 2	✓	✓	✗	✓	✗	10 - 120 %	Vnom (L-N)
3	Volts 3	✓	✓	✗	✗	✗	10 - 120 %	Vnom (L-N)
4	IL1	✓	✓	✓	✓	✓	10 - 120 %	Inom
5	IL2	✓	✓	✗	✓	✗	10 - 120 %	Inom
6	IL3	✓	✓	✗	✗	✗	10 - 120 %	Inom
7	W1	✓	✗	✓	✓	✓	10 - 120 %	Nom ⁽³⁾
8	W2	✓	✗	✗	✓	✗	10 - 120 %	Nom ⁽³⁾
9	W3	✓	✗	✗	✗	✗	10 - 120 %	Nom ⁽³⁾
10	VA1	✓	✗	✓	✓	✓	10 - 120 %	Nom ⁽³⁾
11	VA2	✓	✗	✗	✓	✗	10 - 120 %	Nom ⁽³⁾
12	VA3	✓	✗	✗	✗	✗	10 - 120 %	Nom ⁽³⁾
13	VAr1	✓	✗	✓	✓	✓	10 - 120 %	Nom ⁽³⁾
14	VAr2	✓	✗	✗	✓	✗	10 - 120 %	Nom ⁽³⁾
15	VAr3	✓	✗	✗	✗	✗	10 - 120 %	Nom ⁽³⁾
16	PF1 #	✓	✗	✓	✓	✓	10 - 90 %	90°
17	PF2 #	✓	✗	✗	✓	✗	10 - 90 %	90°
18	PF3 #	✓	✗	✗	✗	✗	10 - 90 %	90°
19	PA1 #	✓	✗	✓	✓	✓	10 - 90 %	360°
20	PA2 #	✓	✗	✗	✓	✗	10 - 90 %	360°
21	PA3 #	✓	✗	✗	✗	✗	10 - 90 %	360°
22	Volts Ave.	✓	✓	✗	✓	✗	10 - 120 %	Vnom ⁽²⁾
24	Current Ave.	✓	✓	✗	✓	✗	10 - 120 %	Inom
27	Watts sum	✓	✓	✗	✓	✗	10 - 120 %	Nom ⁽³⁾
29	VA sum	✓	✓	✗	✓	✗	10 - 120 %	Nom ⁽³⁾
31	VAr sum	✓	✓	✗	✓	✗	10 - 120 %	Nom ⁽³⁾
32	PF Ave. #	✓	✓	✗	✓	✗	10 - 90 %	90°
34	PA Ave. #	✓	✓	✗	✓	✗	10 - 90 %	360°
36	Freq. #	✓	✓	✓	✓	✓	10 - 90 %	66 Hz ⁽¹⁾
37	Wh Import	✓	✓	✓	✓	✓	10 - 9999999	Nom ⁽³⁾

TABLE 3 : Continued...

Parameter Number	Parameter	3P 4W	3P 3W	1P 2W	1P 3W	2P 2W	Trip Point Set Range	100% Value
38	Wh Export	✓	✓	✓	✓	✓	10 - 9999999	Nom ⁽³⁾
39	VArh Capacitive	✓	✓	✓	✓	✓	10 - 9999999	Nom ⁽³⁾
40	VArh Inductive	✓	✓	✓	✓	✓	10 - 9999999	Nom ⁽³⁾
41	VAh	✓	✓	✓	✓	✓	10 - 9999999	Nom ⁽³⁾
43	Watt Demand Imp.	✓	✓	✓	✓	✓	10 - 120 %	Nom ⁽³⁾
44	Watt Max Demand Imp.	✓	✓	✓	✓	✓	10 - 120 %	Nom ⁽³⁾
45	Watt Demand Exp.	✓	✓	✓	✓	✓	10 - 120 %	Nom ⁽³⁾
46	Watt Demand Max Exp.	✓	✓	✓	✓	✓	10 - 120 %	Nom ⁽³⁾
47	VAr Demand Cap.	✓	✓	✓	✓	✓	10 - 120 %	Nom ⁽³⁾
48	VAr Max Demand Cap.	✓	✓	✓	✓	✓	10 - 120 %	Nom ⁽³⁾
49	VAr Demand Ind.	✓	✓	✓	✓	✓	10 - 120 %	Nom ⁽³⁾
50	VAr Demand Max Ind.	✓	✓	✓	✓	✓	10 - 120 %	Nom ⁽³⁾
51	VA Demand	✓	✓	✓	✓	✓	10 - 120 %	Nom ⁽³⁾
52	VA Max Demand	✓	✓	✓	✓	✓	10 - 120 %	Nom ⁽³⁾
53	Current Demand	✓	✓	✓	✓	✓	10 - 120 %	Inom
54	Current Max Demand	✓	✓	✓	✓	✓	10 - 120 %	Inom
85	Re-Active PF L1	✓	✗	✓	✓	✓	10 - 90 %	90°
86	Re-Active PF L2	✓	✗	✗	✓	✗	10 - 90 %	90°
87	Re-Active PF L3	✓	✗	✗	✗	✗	10 - 90 %	90°
88	Avg Re-Active PF	✓	✓	✗	✓	✗	10 - 90 %	90°
90	LF SgnQ(1-(P/S)) L1	✓	✗	✓	✓	✓	10 - 90 %	90°
91	LF SgnQ(1-(P/S)) L2	✓	✗	✗	✓	✗	10 - 90 %	90°
92	LF SgnQ(1-(P/S)) L3	✓	✗	✗	✗	✗	10 - 90 %	90°
93	Avg LF SgnQ(1-(P/S))	✓	✓	✗	✓	✗	10 - 90 %	90°
95	Displacement PF L1	✓	✗	✓	✓	✓	10 - 90 %	90°
96	Displacement PF L2	✓	✗	✗	✓	✗	10 - 90 %	90°
97	Displacement PF L3	✓	✗	✗	✗	✗	10 - 90 %	90°
98	Avg Displacement PF	✓	✓	✗	✓	✗	10 - 90 %	90°
101	V12	✓	✗	✗	✓	✗	10 - 120 %	Vnom (L-L)
102	V23	✓	✗	✗	✗	✗	10 - 120 %	Vnom (L-L)
103	V31	✓	✗	✗	✗	✗	10 - 120 %	Vnom (L-L)
128	Distortion VAr L1	✓	✗	✓	✓	✓	10 - 120 %	Nom ⁽³⁾

TABLE 3 : Continued...

Parameter Number	Parameter	3P 4W	3P 3W	1P 2W	1P 3W	2P 2W	Trip Point Set Range	100% Value
129	Distortion VAR L2	✓	✗	✗	✓	✗	10 - 120 %	Nom ⁽³⁾
130	Distortion VAR L3	✓	✗	✗	✗	✗	10 - 120 %	Nom ⁽³⁾
132	SUM Distortion VAR	✓	✓	✗	✓	✗	10 - 120 %	Nom ⁽³⁾
133	Fundamental VAR L1	✓	✗	✓	✓	✓	10 - 120 %	Nom ⁽³⁾
134	Fundamental VAR L2	✓	✗	✗	✓	✗	10 - 120 %	Nom ⁽³⁾
135	Fundamental VAR L3	✓	✗	✗	✗	✗	10 - 120 %	Nom ⁽³⁾
137	SUM Fundamental VAR	✓	✓	✗	✓	✗	10 - 120 %	Nom ⁽³⁾
198	Relay manually off	✓	✓	✓	✓	✓	1	-
199	Relay manually on	✓	✓	✓	✓	✓	1	-
200	Wh import	✓	✓	✓	✓	✓	10-9999999	Nom ⁽³⁾
201	Wh export	✓	✓	✓	✓	✓	10-9999999	Nom ⁽³⁾
202	VARh Capacitive	✓	✓	✓	✓	✓	10-9999999	Nom ⁽³⁾
203	VARh Inductive	✓	✓	✓	✓	✓	10-9999999	Nom ⁽³⁾
204	VAh	✓	✓	✓	✓	✓	10-9999999	Nom ⁽³⁾
206	Active Energy Import L1	✓	✗	✗	✓	✗	10-9999999	Nom ⁽³⁾
207	Active Energy Import L2	✓	✗	✗	✓	✗	10-9999999	Nom ⁽³⁾
208	Active Energy Import L3	✓	✗	✗	✗	✗	10-9999999	Nom ⁽³⁾
209	Active Energy Export L1	✓	✗	✗	✓	✗	10-9999999	Nom ⁽³⁾
210	Active Energy Export L2	✓	✗	✗	✓	✗	10-9999999	Nom ⁽³⁾
211	Active Energy Export L3	✓	✗	✗	✗	✗	10-9999999	Nom ⁽³⁾
212	Reactive Energy Capacitive L1	✓	✗	✗	✓	✗	10-9999999	Nom ⁽³⁾
213	Reactive Energy Capacitive L2	✓	✗	✗	✓	✗	10-9999999	Nom ⁽³⁾
214	Reactive Energy Capacitive L3	✓	✗	✗	✗	✗	10-9999999	Nom ⁽³⁾
215	Reactive Energy Inductive L1	✓	✗	✗	✓	✗	10-9999999	Nom ⁽³⁾
216	Reactive Energy Inductive L2	✓	✗	✗	✓	✗	10-9999999	Nom ⁽³⁾
217	Reactive Energy Inductive L3	✓	✗	✗	✗	✗	10-9999999	Nom ⁽³⁾
218	Apparent Energy L1	✓	✗	✗	✓	✗	10-9999999	Nom ⁽³⁾
219	Apparent Energy L2	✓	✗	✗	✓	✗	10-9999999	Nom ⁽³⁾
220	Apparent Energy L3	✓	✗	✗	✗	✗	10-9999999	Nom ⁽³⁾
224	Total Sys Active Energy	✓	✓	✓	✓	✓	10-9999999	Nom ⁽³⁾
225	Total Sys Reactive Energy	✓	✓	✓	✓	✓	10-9999999	Nom ⁽³⁾
226	Total Sys Apparent Energy	✓	✓	✓	✓	✓	10-9999999	Nom ⁽³⁾

TABLE 3 : Continued...

Parameter Number	Parameter	3P 4W	3P 3W	1P 2W	1P 3W	2P 2W	Trip Point Set Range	100% Value
227	Total Active Energy L1	✓	✗	✗	✓	✗	10-9999999	Nom ⁽³⁾
228	Total Active Energy L2	✓	✗	✗	✓	✗	10-9999999	Nom ⁽³⁾
229	Total Active Energy L3	✓	✗	✗	✗	✗	10-9999999	Nom ⁽³⁾
230	Total Reactive Energy L1	✓	✗	✗	✓	✗	10-9999999	Nom ⁽³⁾
231	Total Reactive Energy L2	✓	✗	✗	✓	✗	10-9999999	Nom ⁽³⁾
232	Total Reactive Energy L3	✓	✗	✗	✗	✗	10-9999999	Nom ⁽³⁾

Note : Parameters 1,2,3 are L-N Voltage for 3P4W & 1P3W and L-L Voltage for 3P3W & 2P2W.

#Note : Refer #Note of Section 5.2 for details.

- (1) For Frequency 0% corresponds to 45 Hz and 100% corresponds to 66 Hz.
- (2) For 3P 4W, 1P2W and 1P3W the nominal value is VLN and that for 3P 3W and 2P2W is VLL.
- (3) Nominal Value for power is calculated from Nominal Voltage and current values.

Nominal Value is to be considered with set CT/ PT Primary values.
 For 3P4W, L1 phase values are to be considered as system values.
 Trip point for energy parameters is a whole (non-decimal) number.

6.3 Timer Output

Timer output can be used to operate the Relay in a cyclic manner. The user can define the ON period and OFF period and also the number of times this cycle is to be repeated. The number of Cycles (N) can be indefinite or 1 to 9999. The counting is shown on a measurement screen as explained before.

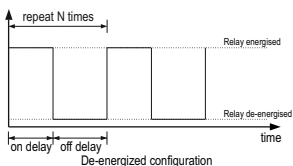
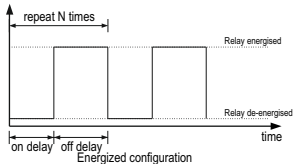

6.4 Load Health Monitor

This is applicable only for Three Phase system. It shows different types of faults related to Three Phase Load connected. Refer Section 3.2.6 for allowed limit setting and Section 3.2.5.1.1.4.1 for relay assignment setting.

Types of faults shown:

- | | | |
|----------------------|----------------------|-------------------|
| 1) over current | 2) over voltage | 3) under voltage |
| 4) under frequency | 5) Phase fail | 6) Phase reversal |
| 7) Unbalance current | 8) Unbalance voltage | |

6.5 Pre-Paid Energy

Pre-Paid Energy is used to show Balance energy, Balance cost, Unit cost, Topup Recharge and New Recharge for the energy selected.

For Example:

- 1) Select Wh import in Parameter select i.e. Parameter '0' (see Section 3.2.5.1.1.5.1).
- 2) Set Unit Cost as 3.5 (see Section 3.2.5.1.1.5.2).
- 3) Initially for new meter set new recharge as 1000 (see Section 3.2.5.1.1.5.4).
- 4) Automatically topup recharge will become 1000 (see Section 3.2.5.1.1.5.3).
- 5) Balance cost for this energy will 1000.
- 6) Balance energy = Balance cost / Unit Cost = $1000 / 3.5$
= **285.714**

If remaining Balance cost is 100 out of 1000 and then topup recharge of 1000 is done, then the Balance cost will become 1100.

Note :

- 1) If new recharge is done then topup recharge, Balance cost and Balance energy will be reset.
- 2) If relay mode is changed, then balance cost and balance energy will automatically set according to the topup recharge.

6.6 RTC Relay

RTC relay output can be used to operate the relay for multiple settings, like relay configuration :- it can be energized or de-energized, On Time and Off Time :- cannot be same this should have to set different according to the settings, week days :- to repeat that setting in a week on multiple days like if Sunday, Monday and Saturday is selected then set "1100001".

TABLE 5 : Datalogging Parameters List

Para. No.	Parameter	Higher Model					Lower Model				
		3P4W	3P3W	1P2W	1P3W	2P2W	3P4W	3P3W	1P2W	1P3W	2P2W
0	V1	✓	✓	✓	✓	✓	✓	✓	✓	✓	✓
1	V2	✓	✓	✗	✓	✗	✓	✓	✗	✓	✗
2	V3	✓	✓	✗	✗	✗	✓	✓	✗	✗	✗
3	I1	✓	✓	✓	✓	✓	✓	✓	✓	✓	✓
4	I2	✓	✓	✗	✓	✗	✓	✓	✗	✓	✗
5	I3	✓	✓	✗	✗	✗	✓	✓	✗	✗	✗
6	W1	✓	✗	✓	✓	✓	✓	✗	✓	✓	✓
7	W2	✓	✗	✗	✓	✗	✓	✗	✗	✓	✗
8	W3	✓	✗	✗	✗	✗	✓	✗	✗	✗	✗
9	VA1	✓	✗	✓	✓	✓	✓	✗	✓	✓	✓
10	VA2	✓	✗	✗	✓	✗	✓	✗	✗	✓	✗
11	VA3	✓	✗	✗	✗	✗	✓	✗	✗	✗	✗
12	VAR1	✓	✗	✓	✓	✓	✓	✗	✓	✓	✓
13	VAR2	✓	✗	✗	✓	✗	✓	✗	✗	✓	✗
14	VAR3	✓	✗	✗	✗	✗	✓	✗	✗	✗	✗
15	PF1	✓	✗	✓	✓	✓	✗	✗	✗	✓	✓
16	PF2	✓	✗	✗	✓	✗	✗	✗	✗	✓	✗
17	PF3	✓	✗	✗	✗	✗	✗	✗	✗	✗	✗
18	Angle1	✓	✗	✓	✓	✓	✗	✗	✗	✓	✓
19	Angle2	✓	✗	✗	✓	✗	✗	✗	✗	✓	✗
20	Angle3	✓	✗	✗	✗	✗	✗	✗	✗	✗	✗
21	Volt Avg	✓	✓	✗	✓	✗	✓	✓	✗	✓	✗
22	Volt Sum	✓	✓	✗	✓	✗	✓	✓	✗	✓	✗
23	Current Avg	✓	✓	✗	✓	✗	✓	✓	✗	✓	✗
24	Current Sum	✓	✓	✗	✓	✗	✓	✓	✗	✓	✗
25	Watt Avg	✓	✓	✗	✓	✗	✓	✓	✗	✓	✗
26	Watt Sum	✓	✓	✗	✓	✗	✓	✓	✗	✓	✗
27	VA Avg	✓	✓	✗	✓	✗	✓	✓	✗	✓	✗
28	VA Sum	✓	✓	✗	✓	✗	✓	✓	✗	✓	✗

TABLE 5 : Continued...

Para. No.	Parameter	Higher Model					Lower Model				
		3P4W	3P3W	1P2W	1P3W	2P2W	3P4W	3P3W	1P2W	1P3W	2P2W
29	VAR Avg	✓	✓	✗	✓	✗	✓	✓	✗	✓	✗
30	VAR Sum	✓	✓	✗	✓	✗	✓	✓	✗	✓	✗
31	PF Avg	✓	✓	✗	✓	✗	✓	✓	✓	✓	✓
32	PF Sum	✓	✓	✗	✓	✗	✗	✗	✗	✗	✗
33	Phase Angle Avg	✓	✓	✗	✓	✗	✓	✓	✗	✓	✗
34	Phase Angle Sum	✓	✓	✗	✓	✗	✗	✗	✗	✗	✗
35	Freq	✓	✓	✓	✓	✓	✓	✓	✓	✓	✓
36	Wh import	✓	✓	✓	✓	✓	✓	✓	✓	✓	✓
37	Wh export	✓	✓	✓	✓	✓	✓	✓	✓	✓	✓
38	VARh Capacitive	✓	✓	✓	✓	✓	✓	✓	✓	✓	✓
39	VARh Inductive	✓	✓	✓	✓	✓	✓	✓	✓	✓	✓
40	VAh	✓	✓	✓	✓	✓	✓	✓	✓	✓	✓
42	kw imp demand	✓	✓	✓	✓	✓	✗	✗	✗	✗	✗
43	max kW imp demand	✓	✓	✓	✓	✓	✗	✗	✗	✗	✗
44	kW exp demand	✓	✓	✓	✓	✓	✗	✗	✗	✗	✗
45	max kW exp demand	✓	✓	✓	✓	✓	✗	✗	✗	✗	✗
46	kVA Cap. demand	✓	✓	✓	✓	✓	✗	✗	✗	✗	✗
47	max kVA Cap. demand	✓	✓	✓	✓	✓	✗	✗	✗	✗	✗
48	kVA Ind. demand	✓	✓	✓	✓	✓	✗	✗	✗	✗	✗
49	max kVA Ind. demand	✓	✓	✓	✓	✓	✗	✗	✗	✗	✗
50	KVA demand	✓	✓	✓	✓	✓	✗	✗	✗	✗	✗
51	max KVA demand	✓	✓	✓	✓	✓	✗	✗	✗	✗	✗
52	current demand	✓	✓	✓	✓	✓	✗	✗	✗	✗	✗
53	max current demand	✓	✓	✓	✓	✓	✗	✗	✗	✗	✗
54	Import active energy overflow count	✓	✓	✓	✓	✓	✓	✓	✓	✓	✓
56	Export active energy overflow count	✓	✓	✓	✓	✓	✓	✓	✓	✓	✓
58	Capacitive reactive energy overflow count	✓	✓	✓	✓	✓	✓	✓	✓	✓	✓
60	Inductive reactive energy overflow count	✓	✓	✓	✓	✓	✓	✓	✓	✓	✓
62	Apparent energy overflow count	✓	✓	✓	✓	✓	✓	✓	✓	✓	✓

TABLE 5 : Continued...

Para. No.	Parameter	Higher Model					Lower Model				
		3P4W	3P3W	1P2W	1P3W	2P2W	3P4W	3P3W	1P2W	1P3W	2P2W
66	system voltage max	✓	✓	✓	✓	✓	✓	✓	✓	✓	✓
67	system voltage min	✓	✓	✓	✓	✓	✓	✓	✓	✓	✓
68	RPM	✓	✓	✓	✓	✓	✓	✓	✓	✓	✓
70	system current max	✓	✓	✓	✓	✓	✓	✓	✓	✓	✓
71	system current min	✓	✓	✓	✓	✓	✓	✓	✓	✓	✓
100	V12	✓	✗	✗	✓	✗	✓	✗	✗	✓	✗
101	V23	✓	✗	✗	✗	✗	✓	✗	✗	✗	✗
102	V31	✓	✗	✗	✗	✗	✓	✗	✗	✗	✗
103	V THD-L1	✓	✓	✓	✓	✓	✗	✗	✗	✓	✓
104	V THD-L2	✓	✓	✗	✓	✗	✗	✗	✗	✓	✗
105	V THD-L3	✓	✓	✗	✗	✗	✗	✗	✗	✗	✗
106	I THD-L1	✓	✓	✓	✓	✓	✗	✗	✗	✓	✓
107	I THD-L2	✓	✓	✗	✓	✗	✗	✗	✗	✓	✗
108	I THD-L3	✓	✓	✗	✗	✗	✗	✗	✗	✗	✗
109	System V-THD	✓	✓	✓	✓	✓	✓	✓	✓	✓	✓
110	System I-THD	✓	✓	✓	✓	✓	✓	✓	✓	✓	✓
112	Neutral Current	✓	✗	✗	✓	✗	✓	✗	✗	✓	✗
113	Run hour	✓	✓	✓	✓	✓	✓	✓	✓	✓	✓
114	On Hour	✓	✓	✓	✓	✓	✓	✓	✓	✓	✓
115	No. of interrupts	✓	✓	✓	✓	✓	✓	✓	✓	✓	✓
121	Phase indicate	✓	✓	✗	✓	✗	✓	✓	✗	✓	✗
127	Distortion VAr L1	✓	✗	✗	✓	✗	✓	✗	✗	✓	✗
128	Distortion VAr L2	✓	✗	✗	✗	✗	✓	✗	✗	✓	✗
129	Distortion VAr L3	✓	✗	✗	✗	✗	✓	✗	✗	✗	✗
130	Distortion VAr AVG	✓	✗	✗	✓	✗	✓	✗	✗	✓	✗
131	Distortion VAr SUM	✓	✓	✓	✓	✓	✓	✓	✓	✓	✓
132	Fundamental VAr L1	✓	✗	✗	✓	✗	✓	✗	✗	✓	✗
133	Fundamental VAr L2	✓	✗	✗	✓	✗	✓	✗	✗	✓	✗
134	Fundamental VAr L3	✓	✗	✗	✗	✗	✓	✗	✗	✗	✗
135	Fundamental VAr AVG	✓	✗	✗	✓	✗	✓	✗	✗	✓	✗
136	Fundamental VAr SUM	✓	✗	✗	✓	✗	✓	✗	✗	✓	✗

7. Phasor Diagram :

Quadrant 1: 0° to 90°

Quadrant 3: 180° to 270°

Quadrant 2: 90° to 180°

Quadrant 4: 270° to 360°

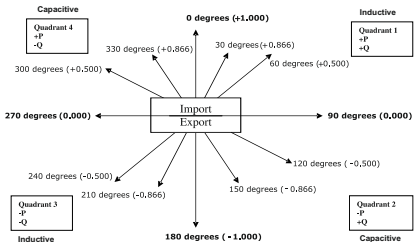

Connections	Quadrant	Sign of Active Power (P)	Sign of Reactive Power (Q)	Sign of Power Factor (PF)	Inductive / Capacitive
Import	1	+ P	+ Q	+	L
Import	4	+ P	- Q	+	C
Export	2	- P	+ Q	-	C
Export	3	- P	- Q	-	L

Inductive means Current lags Voltage

Capacitive means Current leads Voltage

When Multifunction Meter displays Active power (P) with " + " (positive sign), the connection is **"Import"**.

When Multifunction Meter displays Active power (P) with " - " (negative sign), the connection is **"Export"**.

8. Installation

Mounting of the Meter is featured with easy "Clip-in" mounting. Push the meter in panel slot (size 92 x92 mm), it will click fit into panel with the four integral retention clips on two sides of meter. If required, additional support is provided with swivel screws as shown in figure.

The front of the enclosure conforms to IP54. Additional protection to the panel may be obtained by the use of an Optional panel gasket. The terminals at the rear of the product should be protected from liquids.

The Meter should be mounted in a reasonably stable ambient temperature and where the operating temperature is within the range -20 to 70°C. Vibration should be kept to a minimum and the product should not be mounted where it will be subjected to excessive direct sunlight.

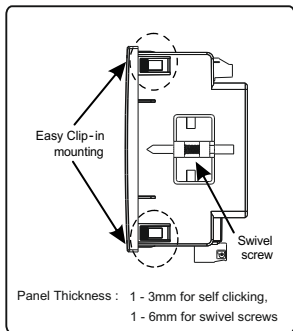

Caution

1. In the interest of safety and functionality this product must be installed by a qualified engineer, abiding by any local regulations.
2. Voltages dangerous to human life are present at some of the terminal connections of this unit. Ensure that all supplies are de-energised before attempting any connection or disconnection.
3. These products do not have internal fuses therefore external fuses must be used to ensure safety under fault conditions.

8.1 EMC Installation Requirements

This product has been designed to meet the certification of the EU directives when installed to a good code of practice for EMC in industrial environments, e.g.

1. Screened output and low signal input leads or have provision for fitting RF suppression components, such as ferrite absorbers, line filters etc., in the event that RF fields cause problems.

Note : It is good practice to install sensitive electronic instruments that are performing critical functions, in EMC enclosures that protect against electrical interference which could cause a disturbance in function.

2. Avoid routing leads alongside cables and products that are, or could be, a source of interference.

3. To protect the product against permanent damage, surge transients must be limited to 2kV pk. It is good EMC practice to suppress differential surges to 2kV at the source. The unit has been designed to automatically recover in the event of a high level of transients. In extreme circumstances it may be necessary to temporarily disconnect the auxiliary supply for a period of greater than 5 seconds to restore correct operation.

The Current inputs of these products are designed for connection in to systems via Current Transformers only, where one side is grounded.

4. ESD precautions must be taken at all times when handling this product.

8.2 Case Dimensions and Panel Cut-Out

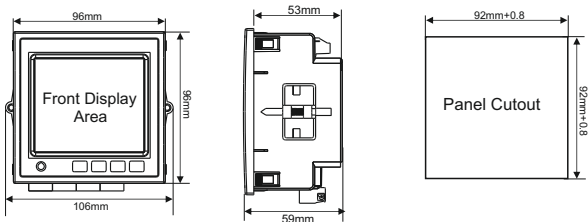

With optional Addon Card:

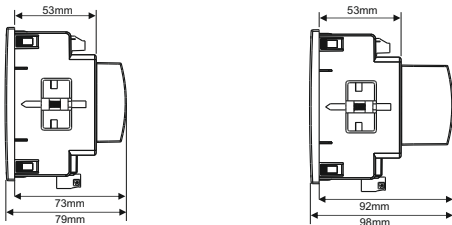

With Modbus or Ethernet.

With Modbus + Ethernet.

8.3 Wiring

Input connections are made directly to screw-type terminals with indirect wire pressure. Numbering is clearly marked on the connector. Choice of cable should meet local regulations. Terminal for both Current and Voltage inputs will accept upto 4mm²(12AWG) solid or 2.5 mm² stranded cable.

Note : It is recommended to use **wire with lug** for **connection with meter**.

Wire: It is suggested to use wire with a temperature rating of at least 83 Deg. C

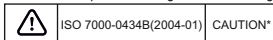

8.4 Auxiliary Supply

Meter should ideally be powered from a dedicated supply, however powered from the signal source, provided the source remains within it may be the limits of the Chosen auxiliary voltage range.

8.5 Fusing

It is recommended that all voltage lines are fitted with 1 Amp HRC fuses or circuit breaker to disconnecting the device.

Specification : Disconnecting device used must be relevant requirements of IEC-60974-1 & IEC-60947-3

For Aux: At most 1.5 times of applied power supply

For measuring input : At most 1.5 times of measuring input.

(Switching time of the device should be < 0.1 sec for Aux & I/P both)

8.6 Earth/Ground Connections

For safety reasons, CT secondary connections should be grounded in accordance with local regulations.

***Note : Refer this Manual wherever the CAUTION symbol is marked.**

9. Connection Diagrams

3-PHASE 3-WIRE UNBALANCED LOAD
DIGITAL METERING SYSTEM (WITH EXTERNAL AUX.)

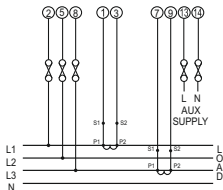

3-PHASE 4-WIRE UNBALANCED LOAD
DIGITAL METERING SYSTEM (WITH EXTERNAL AUX.)

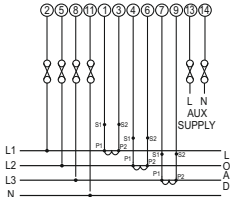

SINGLE PHASE 2-WIRE
DIGITAL METERING SYSTEM (WITH EXTERNAL AUX.)

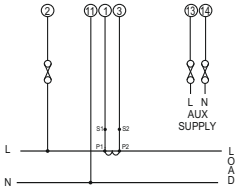

2-PHASE 2-WIRE UNBALANCED LOAD
DIGITAL METERING SYSTEM (WITH EXTERNAL AUX.)

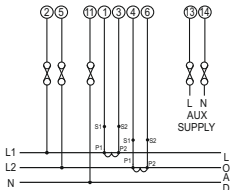
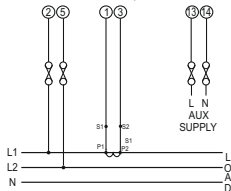

1-PHASE 3-WIRE UNBALANCED LOAD
DIGITAL METERING SYSTEM (WITH EXTERNAL AUX.)

10. Optional Pluggable Module

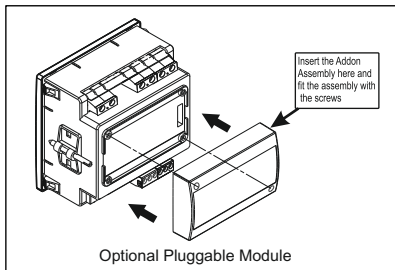

Wiring Guidelines

Solid with Pin type lugs (sq. mm)	1 to 2.5
Stranded with pin types lugs (sq. mm)	1 to 2.5
Torque value (Nm)	
1. Aux and Voltage terminals	0.5 to 0.6
2. Current Terminals	0.4 to 0.5
3. RS485, DI and Relay terminals	0.3 to 0.4
Length available for lug entry in terminal (mm)	9.5

11. Specification

System

3 Phase 3 Wire / 4 Wire, 1 phase 2 Wire / 3 Wire & 2 phase 2 Wire programmable on site.

Inputs

Nominal Input Voltage V_n (AC RMS)

100VLL to 600VLL programmable on site.
(57.5VLN to 346.42VLN)

System PT Primary Values

100VLL to 1200 kVLL, programmable on site

System PT Secondary Values

100VLL to 600VLL programmable on site.
(57.5VLN to 346.42VLN)

Max continuous input voltage

120% of Nominal Value

Nominal input voltage burden

<0.3 VA approx. per Phase (at nominal 240V)

Overload Indication

"-OL-" >121% of Nominal value

Nominal Input Current I_n

1A/5A, programmable on site.

max continuous input current

200% of Nominal value
(180% of Nominal value for CF = 2)

Nominal input current burden

<0.3 VA approx. per phase

System CT primary values

Std. Values 1 to 9999A (1 or 5 Amp secondary)

System CT secondary values

1A/5A, programmable on site

Overload Indication

"-OL-" >205% of Nominal value

Overload withstand

Voltage input

2 x Nominal Value for 1 Second
(1s application at 10s intervals) repeated 10 times

Current input

20 x Nominal Value for 1 Second
(1s application at 5min intervals) repeated 5 times

Auxiliary Supply

External Higher Aux.	100V to 550V AC-DC
Ext. High Aux. (As per IEC 61557-12)	100V to 320V AC-DC
External Higher Aux. Nominal Value	230V AC/DC, 50/60 Hz for AC Aux
External Lower Aux.	12V to 60V AC-DC
External Lower Aux. Nominal Value	24 V AC / 48 V DC, 50/60 Hz for AC Aux
Aux Frequency Range	45 to 66 Hz
VA Burden With RS485 card	< 6 VA approx. (at nominal)
VA Burden With Ethernet card	< 8 VA approx. (at nominal)

Operating Measuring Ranges

Voltage	20 ... 120 % of nominal Value
Current	1....200% of nominal value (1....180% of nominal value for CF = 2)
Starting Current	0.1% of Nominal (as per IEC 62053-22)
Power Factor	0.5 Lag ... 1 ... 0.8 Lead
Frequency	40 to 70 Hz

Note : Variation due to frequency other than +/- 10% of 50/60Hz is less than twice the class index.

Reference conditions for Accuracy

Reference temperature (as per IEC 62053-22)	$23^{\circ}\text{C} \pm 2^{\circ}\text{C}^{\circ}$
Input Waveform	Sinusoidal (distortion factor 0.005)
Input Frequency	50/60 Hz \pm 2%
Auxiliary supply Frequency	50/60 Hz \pm 1%
Total Harmonic Distortion	THDv \leq 50% upto 31st Harmonic at Vn THDv \leq 200% upto 31st Harmonic at In THDv \leq 180% upto 31st Harmonic at In CF = 2
Voltage Range	20 ... 120 % of nominal Value
Current Range	10 ... 200 % of nominal Value

Accuracy

Voltage	$\pm 0.5\%$ (0.2% optional) of nominal value
Current	$\pm 0.5\%$ (0.2% optional) of nominal value
Frequency	$\pm 0.1\%$ of mid frequency
Active power	$\pm 0.5\%$ (0.2% optional) of nominal value
Reactive power	$\pm 1.0\%$ of nominal value
Apparent Power	$\pm 0.5\%$ (0.2% optional) of nominal value
Power Factor / Phase Angle	$\pm 3^\circ$
Active energy	Class 0.5S (0.2S optional) as per IEC 62053-22 Class 0.5 (0.2 optional) as per IEC61557 - 12
Reactive energy	Class 2 as per IEC 62053-23 & 61557 - 12
Apparent energy	Class 1 as per IEC 61557 - 12
THD (V/I) w.r.t. Fundamental	$\pm 5\%$ (upto 31st harmonics)
Individual Harmonics	$\pm 5\%$ (upto 31st harmonics)

Display

4 Line 4 Digit & 1 Line 9 Digit row LCD Display with backlight

Response time to step input	Approx. 1 sec.
Scrolling	Automatic / Manual (Programmable)

Controls

User Interface	4 push buttons
----------------	----------------

Standards

Electromagnetic Compatibility	IEC 61326 - 1, Table 2
Immunity	IEC 61000-4-2,-3,-4,-5,-6,-8,-11
Safety	IEC 61010-1-2010, permanently connected use
Emission	CISPR 11
IP for water & dust	IEC 60529
Pollution degree	2
Installation Category	300V CAT / 600V CAT

Isolation

Protective Class	2
High Voltage Test	
Input+Aux vs Surface	4 kV RMS, 50Hz, 1 min
Input/Aux vs Remaining Circuit	3.3 kV RMS, 50Hz, 1 min
DI/Relay/RS485/USB vs Remaining	3.3 kV RMS, 50Hz, 1 min
DI vs DI/Relay vs Relay	2.2 kV RMS, 50Hz, 1 min
Impulse Voltage Withstand	5kV for 1.2uSec

Environmental conditions

Operating temperature	-20 to +70 °C
Storage temperature	-40 to +85 °C
Relative humidity	0 .. 95 % RH (Non condensing)
Warm up time	3 minute (minimum)
Shock (As per IEC 60068-2-27)	Half Sine wave, Peak acceleration 30gn (300 m/s ²), duration 18 ms
Vibration	10..150..10 Hz, 0.15mm amplitude
Number of Sweep cycles	10 per axis

Enclosure

Enclosure front	IP 54
Enclosure back (Terminals)	IP 20

Dimensions

Bezel Size	96mm x 96mm DIN 43718
Panel cut out	92mm+0.8 X 92mm+0.8
Overall Depth	59 mm without the Add-on Card 79 mm with Ethernet or Modbus Card 98 mm with Ethernet and Modbus Card
Mechanical Housing	Lexan 940 (polycarbonate), Flammability Class V-0 acc. to UL94, self extinguishing, non dripping, free of halogen
Connection Element	Conventional screw type terminal with indirect wire terminals
Connection Terminal	4 mm ² solid or 2.5 mm ² stranded cable

Panel thickness	1 - 3mm for self clicking 1 - 6mm for swivel screws
Weight	320 grams Approx.
Interfaces	
Impulse Led	For Energy testing
Digital Input (optional)	20...300 VAC / 10...60 VDC Optical Couplers, Min Pulse width 10msec Min length between two pulses 18msec VA Consumption : < 0.25VA at 240 VAC
Relay (optional)	250 VAC, 5 AAC 30V DC, 5A DC
Modbus (optional)	RS485, max.1200m Baud rate : 4.8k, 9.6k, 19.2k, 38.4k, 57.6kbps
Ethernet (optional)	Ethernet access on modbus TCP/IP Protocol
Pulse output Option	
Relay	2NO
Switching Voltage & Current	240 VAC , 5 AAC / 30VDC, 5A DC.
Default Pulse rate Divisor	1 per Wh (up to 3600W), 1 per kWh (up to 3600kW), 1 per MWh (above 3600 kW up to 30000 kW)
Pulse rate Divisors	
10	Programmable on site 1 per 10Wh (up to 3600W), 1 per 10kWh (up to 3600kW), 1 per 10MWh (above 3600 kW up to 30000 kW)
100	1 per 100Wh (up to 3600W), 1 per 100kWh (up to 3600 kW), 1 per 100MWh (above 3600 kW up to 30000 kW)
1000	1 per 1000Wh (up to 3600W), 1 per 1000kWh (up to 3600kW), 1 per 1000MWh (above 3600 kW up to 30000 kW)
Pulse Duration	60ms , 100ms or 200ms

Note :

1. Refer TABLE 2 for details.

2. Above conditions are also applicable for Reactive & Apparent Energy.

Impulse Constant

Depending on nominal system nominal power, the number of impulses are created to measure the energy. The number of impulses for particular nominal power is set which indicates 1kWh energy. Energy can be Watt, VA or Var. Following table shows impulses corresponding to nominal system energy.

System Nominal	Impulse Constant
<= 100	64000
<= 200	32000
<= 400	16000
<= 800	8000
<= 1600	4000
<= 3200	2000
> 3200	1000

1. For per phase / 1P2W System Energy,

$$\text{Nominal Power} = \text{PT Sec (LL)} * \text{CT Sec} / 1.732$$

2. For two Phase Two Wire System Energy,

$$\text{Nominal Power} = 2 * \text{PT Sec (LL)} * \text{CT Sec} / 1.732$$

3. For Three Phase System Energy,

$$\text{Nominal Power} = 3 * \text{PT Sec (LL)} * \text{CT Sec} / 1.732$$

*Note :

Impulse Constant of 16000 and 32000 are applicable for 1P2W System and per phase energy of Three Phase System.

12. Connection for Optional Pulse Output / Digital Input / RS 485 / Ethernet Module (rear (back) view of Multifunction Meter):

Location of Modbus, 2 Relay
& 4 Digital Inputs

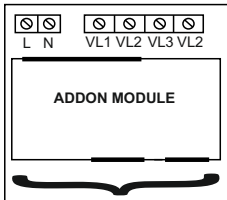

Location of Ethernet

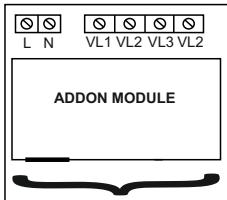

1.Down Side

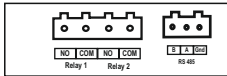

2.Up Side

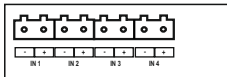

NOTE