

Operating Manual

POWER \ PHASE ANGLE \ POWER FACTOR TRANSDUCER RISH CON - P



POWER \ PHASE ANGLE \ POWER FACTOR TRANSDUCER

POWER \ PHASE ANGLE \ POWER FACTOR TRANSDUCER

Installation & Operating Instructions

Section Contents

1. Introduction
2. Input and Output screens
3. Programming
 - 3.1 Programming Via Front LCD & Two keys
 - 3.1.1 Password Protection
 - 3.1.1.1 Password Verification
 - 3.1.1.2 Editing Existing Password
 - 3.1.2 Transducer Type Selection
 - 3.1.3 System Type Selection
 - 3.1.4 Output Type Selection
 - 3.1.4.1 Output 1 Type Selection
 - 3.1.4.2 Output 2 Type Selection
 - 3.1.5 Potential Transformer Parameter Setting
 - 3.1.5.1 Potential Transformer primary value
 - 3.1.5.2 Potential Transformer secondary value
 - 3.1.6 Current Transformer Parameter Setting
 - 3.1.6.1 Current Transformer Primary Value
 - 3.1.6.2 Current Transformer Secondary Value
 - 3.1.7 Communication Parameter Setting
 - 3.1.7.1 Address Setting
 - 3.1.7.2 RS 485 Baud rate
 - 3.1.7.3 RS 485 Parity selection

- 3.1.8 Input Characteristics Setting
 - 3.1.8.1 End value of Input
 - 3.1.8.2 Start value of Input
 - 3.1.8.3 Elbow Function Selection
 - 3.1.8.4 Elbow value of input
- 3.1.9 Output Characteristics setting
 - 3.1.9.1 Output 1 Characteristics setting
 - 3.1.9.1.1 End value of output 1
 - 3.1.9.1.2 Start value of output 1
 - 3.1.9.1.3 Elbow value of output 1
 - 3.1.9.2 Output 2 Characteristics setting
 - 3.1.9.2.1 End value of output 2
 - 3.1.9.2.2 Start value of output 2
 - 3.1.9.2.3 Elbow value of output 2
- 3.1.10 Mode Selection
- 3.2 Programming Via Programming port available at front of Transducers using optional PRKAB601 Adapter
- 3.3 Programming Via optional RS485(MODBUS)communication port.
 - 3.3.1 DIP Switch Setting for Changing Output type
- 4. RS 485 (Modbus)
- 5. Phaser Diagram
- 6. Installation
 - 6.1 EMC Installation Requirements
 - 6.2 Case Dimensions
 - 6.3 Wiring
 - 6.4 Auxiliary Supply
 - 6.5 Fusing
 - 6.6 Earth / Ground Connections
 - 6.7 Maintenance
- 7. Specifications
- 8. Connection Diagrams

1. Introduction

The POWER/PHASE ANGLE/ POWER FACTOR TRANSDUCER is a DIN Rail/Wall mounted 78.5 X 65.5mm Transducer.

The Transducer is used to measure and convert Active, Apparent, Reactive Power, Phase Angle & Power Factor of a Single phase or Three phase AC System with balanced or unbalanced load into an proportional DC current or voltage output signal.

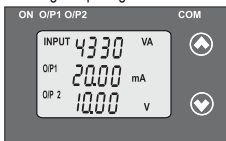

Transducer can be configured and programmed on site for the following :

PT Primary ,PT Secondary, CT Primary, CT Secondary, Input Characteristics (i.e start, end and elbow value of Input) and

Output Characteristics (i.e Voltage or Current and start, end and elbow Value of outputs.)

The front panel has two push buttons through which the user can enter into programming mode and can configure the transducer.

1.1: LED Indication

LED	LED OPERATING CONDITION	LED OPERATING STATUS
ON	Aux. Supply healthy condition	Green LED continuous ON
O/P 1	Output1 Voltage Output1 Current	Green LED continuous ON Red LED continuous ON
O/P 2	Output2 Voltage Output2 Current	Green LED continuous ON Red LED continuous ON

Table 1: Measured parameters

Measured parameters	Unit of Measurement
Active Power	W
Reactive Power	VA _r
Apparent Power	VA
Power Factor	–
Phase Angle	°(DEG)

2 . Input and Output screens

In normal operation the user is presented with display test screen followed by version screen to one of the output screen.

For Apparent Power Transducer :
Input Apparent Power,
Output 1 as Current or Voltage
Output 2 as Current or Voltage

For Reactive Power Transducer,
Input Reactive Power,
Output 1 as Current or Voltage
Output 2 as Current or Voltage

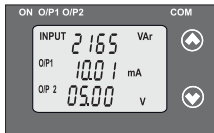
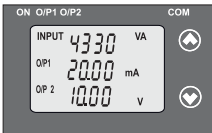

For Active Power Transducer,
Input Active Power,
Output 1 as Current or Voltage
Output 2 as Current or Voltage

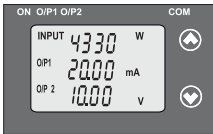

For Power Factor Transducer
Input Power Factor,
Output 1 as Current or Voltage
Output 2 as Current or Voltage

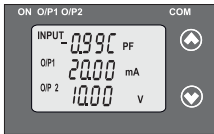

For Phase Angle Transducer
Input Phase Angle
Output 1 as Current or Voltage and Output 2 as Current or Voltage



3. Programming

Programming of transducer can be done in three ways :

- 3.1. Programming Via Front LCD & Two keys.
- 3.2. Programming Via Programming port available at front of Transducers using optional PRKAB601 Adapter.
- 3.3. Programming Via optional RS485(MODBUS) communication port.

3.1: Programming Via Front LCD & Two keys

The following sections comprise step by step procedures for configuring the Transducer for individual user requirements.

To access the set-up screens press and hold the “▼ Down” and “▲ Up” keys simultaneously for 5 seconds. This will take the User to the password screen .

3.1.1: Password Protection:

3.1.1.1: Password Verification

Password protection can be enabled to prevent unauthorized access to set-up screens, by default password protection is not enabled.

Password protection is enabled by selecting a four digit number other than 0000. Setting a password of 0000 disables the password protection.



Enter Password, prompt for first digit. (*Denotes that digit will be flashing). Pressing the “▼ Down” key will scroll the value of the first digit from 0 to 9 and the value will roll back again to 0. Pressing the “▲ Up” key will

advance the operation to next digit and set the first digit.

In the special case where the Password is “0000” pressing the “▲ Up” key when prompted for the First digit will advance to the “Password Confirmation”mode.



After first digit gets entered, it will prompt for second digit. (*Denotes that digit will be flashing). Pressing the “▼ Down” key will scroll the value of the second digit from 0 to 9 and the value will roll back again to 0.

Pressing the “▲ Up” key will advance the Operation to the next digit and set the second digit.



After, second digit gets entered, it will prompt for third digit.
(*Denotes that digit will be flashing).
Pressing the "▼ Down" key will scroll the value of the third digit from 0 to 9 and the value will roll back again to 0.

Pressing the "▲ Up" key will advance the Operation to the next digit and set the third digit.



After, third digit get entered, it will prompt for fourth digit.
(*Denotes that digit will be flashing).
Pressing the "▼ Down" key will scroll the value of the fourth digit from 0 to 9 and the value will roll back again to 0.

Pressing the "▲ Up" key will advance the Operation to the next digit and set the fourth digit.



Confirmation of Password

Pressing "▼ Down" key will enter to the " Password edit " mode .(section 3.1.1.2)
Pressing the " ▲ Up" key will advance to the Transducer Type selection (section 3.1.2).



Password Incorrect.

This screen is displayed when the unit has not accepted the Password entered.

Pressing the "▼ Down" key will re-enter to the "Enter Password" entry stage.

Pressing the "▲ Up" key will exit the setup menu.

3.1.1.2: Editing Existing Password



Editing Existing Password

(*Denotes that digit will be flashing).
Pressing the "▼ Down" key will scroll the value of the first digit from 0 to 9 and the value will roll back again to 0.

Pressing the "▲ Up" key will advance the operation to the next digit and set the first digit, in this case to "4"



After first digit gets entered, it will prompt for second digit.
(*Denotes that digit will be flashing).
Pressing the "▼ Down" key will scroll the value of the second digit from 0 to 9 and the value will roll back again to 0.

Pressing the "▲ Up" key will advance the operation to the next digit and set the second digit, in this case to "1"



After second digit gets entered, it will prompt for third digit.
(*Denotes that digit will be flashing).
Pressing the "▼ Down" key will scroll the value of the third digit from 0 to 9 and the value will roll back again to 0.

Pressing the "▲ Up" key will advance the operation to the next digit and set the third digit, in this case to "4"



After third digit gets entered, it will prompt for fourth digit.
(* Denotes that digit will be flashing).
Pressing the "▼ Down" key will scroll the value of the fourth digit from 0 to 9 and the value will roll back again to 0.

Pressing the "▲ Up" key will advance the operation to the " Password Confirmation" mode and set the fourth digit, in this case to "1".



Confirmation of Password

Pressing the "▼ Down" key will re-enter to the " Password edit " mode.

Pressing the "▲ Up" key will confirm Password and advance to the Transducer Type Selection (section3.1.2).

3.1.2: Transducer Type Selection:

This screen allows the user to set the transducer type as Active, Reactive, Apparent Power, Phase angle or Power Factor .

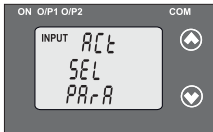

Pressing the “▼ Down” key display will show “Transducer type edit” mode and scroll between

- ACT** : Active Power
- APP** : Apparent Power
- rEA** : Reactive Power
- PF** : Power Factor
- PHA** : Phase Angle

and will roll back again to **ACT** (Parameters are flashing).

Pressing “▲ Up” key will confirm the selected type and advance to the System type selection(section 3.1.3).

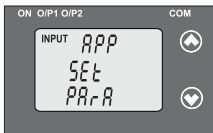

Confirmation of Transducer Type

Pressing “▼ Down” key will re-enter into “Transducer type edit” mode.

Pressing the “▲ Up” key will set the Transducer type and advance to the System type Selection (section 3.1.3).

3.1.3: System Type Selection:

This screen allows the user to set System Type.



Pressing the “▼ Down” key will enter into the “System Type edit” mode. For

Active / Apparent / Reactive Power Transducer, System type will scroll between

- 1PH2** : Single-Phase AC Network
- 3PH4 bAL** : 3-Phase 4-Wire balanced load

3PH3 bAL : 3-Phase 3-Wire balanced load

3PH3 UbAL : 3-Phase 3-Wire Unbalanced load

3PH4 UbAL : 3-Phase 4-Wire Unbalanced load

For Phase angle and Power factor Transducer networks supported are

UL 12 bAL : 3-Phase 3-Wire balanced load

UL 23 bAL : 3-Phase 3-Wire balanced load

UL 31 bAL : 3-Phase 3-Wire balanced load

3PH4 bAL : 3-Phase 4-Wire balanced load

3PH3 bAL : 3-Phase 3-Wire balanced load

1PH2 : Single-Phase AC Network

Pressing “**^** Up” key accepts the present value and advance to the to the Output type selection (section 3.1.4).



Confirmation of System Type

Pressing “**v** Down” key will re-enter into “System Type edit” mode.

Pressing the “**^** Up” key will set the value and advance to the Output type selection (section 3.1.4).

3.1.4.: Output Type Selection:

3.1.4.1: Output 1 Type Selection

This screen allows the user to set the output 1 type as Voltage or Current.



Pressing the “**v** Down” key will enter the transducer into “output 1 type edit” mode and scroll between voltage and current.

Pressing “**^** Up” key will confirm the present type for Output 1 and advance to the Output 2 type selection(section 3.1.4.2).



Confirmation of Output 1 Type

Pressing “▼ Down” key will re-enter into “Output 1 type edit” mode.

Pressing the “▲ Up” key will set the type and advance to the Output 2 type selection(section 3.1.4.2).

3.1.4.2: Output 2 Type Selection

This screen allows the user to set the output 2 type as Voltage or Current for dual output transducer.



Pressing the “▼ Down” key will enter the “output 2 type edit” mode and scroll between voltage and current.

Pressing “▲ Up” key accepts the present type for Output 2 and advance to the Potential Transformer parameter selection(section 3.1.5).



Confirmation of Output 2 Type

Pressing “▼ Down” key will re-enter into “Output 2 type edit” mode.

Pressing the “▲ Up” key will set the type and advance to the Potential Transformer parameter selection (section 3.1.5).

Note: After changing Output type switch off the Transducer and change DIP switch setting.If DIP switch setting is done before changing the output Type through Display.Then change the Output type through Display and switch off the Transducer and then switch ON. (Section 3.3.1)

3.1.5: Potential Transformer Parameter Setting:

3.1.5.1: Potential Transformer primary value

This screen allows the user to set the PT Primary value from 100V to 692.8 KVL-L with consideration that presently written PT Primary value with the previously set CT Primary value would not result in maximum power of greater than 1000 MVA per phase.



Pressing the "▼ Down" key will enter into the "PT Primary value edit" mode.

Pressing "▲ Up" key will confirm the present value as PT Primary and advance to the PT secondary value (Section 3.1.5.2).



Editing Existing PT Primary value

(*Denotes that decimal point will be flashing).
Pressing the "▼ Down" key will scroll the decimal point to the next position.
Pressing the "▲ Up" key will confirm the decimal point position and advance the operation to set the first digit.



(*Denotes that digit will be flashing).
Pressing the "▼ Down" key will scroll the value of the first digit from 0 to 9, and the value will roll back again to 0.

Pressing the "▲ Up" key will advance the operation to the next

digit and set the first digit, in this case to "0".

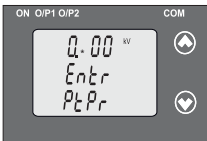

After first digit gets entered, it will prompt for second digit.

(*Denotes that digit will be flashing).

Pressing the "▼ Down" key will scroll the value of the second digit from 0 to 9 and the value will roll back

again to 0 or it will get restricted depending on first digit set.

Pressing the "▲ Up" key will advance the operation to the next digit and set the second digit, in this case to "6".

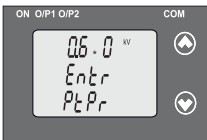

After second digit gets entered, it will prompt for third digit.

(*Denotes that digit will be flashing).

Pressing the "▼ Down" key will scroll the value of the third digit from 0 to 9 and the value will roll back

again to 0 or it will get restricted depending on second digit set.

Pressing the "▲ Up" key will advance the operation to the next digit and set the third digit, in this case to "0".



After third digit gets entered, it will prompt for fourth digit.

(*Denotes that digit will be flashing).

Pressing the "▼ Down" key will scroll the value of the fourth digit from 0 to 9 and the value will roll back

again to 0 or it will get restricted depending on third digit set.

Pressing the "▲ Up" key will advance the operation to the "PT Primary value confirmation" and set the fourth digit, in this case to "0".



Confirmation of PT Primary value

Pressing the “**▼** Down” key will re-enter to the “ PT Primary value edit ” mode.

Pressing the “**▲** Up” key will confirm PT Primary value and advance to the PT Secondary selection (section 3.1.5.2).

3.1.5.2 Potential Transformer Secondary Value

This screen allows the user to set the PT Secondary value from 100 to 500VLL.



Pressing the “**▼** Down” key will enter into the “PT Secondary value edit” mode.

Pressing the “**▲** Up” key will confirm the present value as PT Secondary and advance to the Current Transformer Parameter Setting (section 3.1.6).



Editing Existing PT Secondary value

(*Denotes that digit will be flashing). First Digit is always zero.

Pressing the “**▼** Down” key will scroll the value of the Second digit from 1 to 5 and the value will roll back again to 1.

Pressing the “**▲** Up” key will advance the operation to the next digit and set the second digit, in this case to “3”



After second digit gets entered ,it will prompt for third digit.
(*Denotes that digit will be flashing)

Pressing the "▼ Down" key will scroll the value of the third digit from 0 to 9 and the value will roll back again to 0 or it will get restricted depending on second digit set.

Pressing the "▲ Up" key will advance the operation to the next digit and set the third digit, in this case to "0".



After third digit gets entered ,it will prompt for fourth digit.

(*Denotes that digit will be flashing)
Pressing the "▼ Down" key will scroll the value of the fourth digit from 0 to 9 and the value will roll back again to 0 or it will get restricted

depending on second digit set.

Pressing the "▲ Up" key will advance to "PT secondary value confirmation" mode and set the fourth digit, in this case to "0".



Confirmation of PT Secondary value

Pressing the "▼ Down" key will re-enter into "PT Secondary value edit" mode.

Pressing the "▲ Up" key will confirm PT Secondary value and advance to the Current Transformer

Parameter Selection(section 3.1.6).

3.1.6: Current Transformer Parameter Setting

3.1.6.1: Current Transformer Primary Value

This screen allows the user to set the CT Primary value from 1 to 9999 A with consideration that presently written CT Primary value with the previously set PT Primary value would not result in maximum power of greater than 1000 MVA per phase.



Pressing the “▼ Down” key will enter the transducer into “CT Primary value edit” mode.

Pressing “▲ Up” key will confirm the present value as CT Primary and advance to the CT secondary selection (section 3.1.6.2).



Editing Existing CT Primary Value (*Denotes that digit will be flashing).

Pressing the “▼ Down” key will scroll the value of the first digit from 0 to 9 and the value will roll back again to 0.

Pressing the “▲ Up” key will advance the operation to the next digit and set the first digit, in this case to “0”



After, first digit gets entered, it will prompt for second digit. (*Denotes that digit will be flashing).

Pressing the “▼ Down” key will scroll the value of the second digit from 0 to 9 and the value will roll back again to 0 or it will get restricted

depending on first digit set. Pressing the “▲ Up” key will advance the operation to the next digit and set the second digit, in this case to “0”.



After second digit gets entered, it will prompt for third digit.
(*Denotes that digit will be flashing).

Pressing the "▼ Down" key will scroll the value of the third digit from 0 to 9 and the value will roll back

again to 0 or it will get restricted depending on second digit set.

Pressing the "▲ Up" key will advance the operation to the next digit and set the third digit, in this case to "0".



After third digit gets entered, it will prompt for fourth digit.
(*Denotes that digit will be flashing).

Pressing the "▼ Down" key will scroll the value of the fourth digit from 0 to 9 and the value will roll back again to 0 or it will get restricted

depending on third digit set.

Pressing the "▲ Up" key will advance the operation to the "CT primary value Confirmation" and set the fourth digit, in this case to "5".

Example : If PT primary value is set as 692.8 KVL-L (Max value) then CT primary Will restricted to 1736 A. The "Maximum power" restriction of 1000 MVA refers to 120 % Nominal current & 120 % nominal voltage, i.e. 694.4 MVA Nominal power per phase.



Confirmation of CT Primary value .

Pressing the "▼ Down" key will re-enter to the "CT Primary value edit" mode.

Pressing the "▲ Up" key will confirm CT Primary value and advance to the CT secondary setting (section 3.1.6.2).

3.1.6.2: Current Transformer Secondary Value

This screen allows the user to set the CT Secondary value from 1 to 5A.



Pressing the “▼ Down” key will enter transducer into “CT Secondary value edit” mode.

Pressing the “▲ Up” key will confirm the present value as CT Secondary and advance to the Communication parameter Setting (section 3.1.7).



Editing Existing CT Secondary Value (*Denotes that digit will be flashing).

Pressing the “▼ Down” key will scroll the value from 1 to 5 and value will roll back again to 1.

Pressing the “▲ Up” key will advance

the operation to the “CT Secondary value confirmation” and set digit, in this case to “5”.



Confirmation of CT Secondary Value

Pressing the “▼ Down” key will return to the “CT Secondary value edit” mode.

Pressing the “▲ Up” key will confirm the CT Secondary and advance

to the Communication parameter Selection (section 3.1.7).

3.1.7: Communication Parameter Setting:

3.1.7.1 Address Setting

This screen applies to the RS 485 output only.

This screen allows the user to set RS485 parameter for instruments. The allowable range of address is 1 to 247.



Pressing "▼ Down" key will advance to the "address value edit" mode.

Pressing the "▲ Up" key will confirm the present value as address and advance to Baud Rate selection (section 3.1.7.2).



Editing Existing Address Value

(*Denotes that digit will be flashing).

First digit is always blank.

Pressing the "▼ Down" key will scroll the value of the second digit from 0 to 2 and the value will roll back again to 0.

Pressing the "▲ Up" key will advance the operation to the next digit and set the second digit, in this case to "0".



After, second digit gets entered, it will prompt for third digit.

(*Denotes that digit will be flashing).

Pressing the "▼ Down" key will scroll the value of the third digit from 0 to 9 and the value will roll back again to 0 or it will get restricted depending on

second digit set. Pressing the "▲ Up" key will advance the operation to the next digit and set the third digit, in this case to "0".



After third digit gets entered, it will prompt for fourth digit.
(* denotes that digit will be flashing).
Pressing the "▼ Down" key will scroll the value of the fourth digit from 0 to 9 and the value will roll back again to 0 or it will get restricted

depending on third digit set.

Pressing the "▲ Up" key will advance the operation to the "Address value confirmation" mode and set the fourth digit, in this case to "1".



Confirmation of Address Value

Pressing the "▼ Down" key will re-enter to the "Address value edit" mode.

Pressing the "▲ Up" key will confirm Address value and advance to Baud Rate selection (section 3.1.7.2).

3.1.7.2: RS 485 Baud rate



This screen allows the user to set Baud Rate of RS 485 port. The values displayed on screen are in kbaud. Pressing the "▼ Down" key will enter into the "Baud Rate edit" mode and scroll the value between 2.4, 4.8, 9.6, 19.2 and value will roll back again to 2.4 (values are flashing).

Pressing "▲ Up" key will confirm the present value as Baud rate and advance to the RS485 Parity Selection (section 3.1.7.3).



Confirmation of RS 485 Baud Rate

Pressing "▼ Down" key will re-enter into the "Baud Rate edit" mode.

Pressing the "▲ Up" key will confirm the Baud rate value and advance to the Parity Selection (section 3.1.7.3).

3.1.7.3: RS 485 Parity Selection

This screen allows the user to set Parity & number of stop bits of RS 485 port.

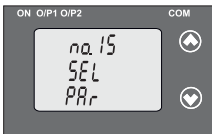

Pressing the "▼ Down" key will enter into the "Parity & stop bit edit" mode and scroll the value between

- odd** : odd parity with one stop bit
- no. 1S** : no parity with one stop bit
- no. 2S** : no parity with two stop bit
- EVEn** : even parity with one stop bit

Pressing "▲ Up" key accepts the present value and advance to the Input Characteristics selection(section 3.1.8).



Confirmation of RS 485 Parity

Pressing "▼ Down" key will be re-enter into "Parity edit" mode.

Pressing the "▲ Up" key will set the value and advance to the Input Characteristics selection (section 3.1.8).

3.1.8: Input Characteristics Setting*

3.1.8.1: End value of Input

This screen allows the user to set the End value of Input with respect to system type & Transducer type. Allowable range of End value is 30% to 130% of Rated power.(Consider that we have Selected the Input as Apparent Power.)



Pressing the "▼ Down" key will enter into "Input End value edit" mode.

Pressing "▲ Up" key will confirm the present value as Input End value and advance to the Start value of Input (section 3.1.8.2).

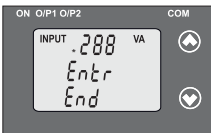

Editing Existing Input End value

(*Denotes that digit will be flashing).

Pressing the "▼ Down" key will scroll the value of the first digit from 0 to 5 and the value will roll back again to 0.

Pressing the "▲ Up" key will

advance the operation to the next digit and set the first digit, in this case to "5".

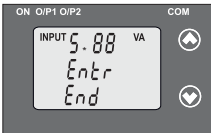

After first digit gets entered, it will prompt for second digit.

(*Denotes that digit will be flashing).

Pressing the "▼ Down" key will scroll the value of the second digit from 0 to 9, and the value will roll back again to 0 or get restricted depending

on the value of first digit. Pressing the "▲ Up" key will advance the operation to the next digit and set the second digit, in this case to "0".

* Note:- Enter values in terms of secondary value.

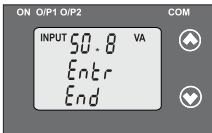

After second digit gets entered, it will prompt for third digit.
 (*Denotes that digit will be flashing).

Pressing the "▼ Down" key will scroll the value of the third digit from 0 to 9 and the value will roll back again

to 0 or value will get restricted depending on the value of second digit.

Pressing the "▲ Up" key will advance the operation to the next digit and set the third digit, in this case to "6".

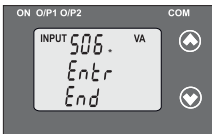

After third digit gets entered, it will prompt for fourth digit.
 (*Denotes that digit will be flashing).

Pressing the "▼ Down" key will scroll the value of the fourth digit from 0 to 9 and the value will roll back again to 0 or value will get

restricted depending on the value of third digit.

Pressing the "▲ Up" key will advance the operation to the next digit And set the fourth digit, in this case to "6".

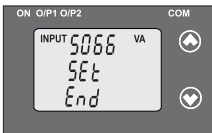

Confirmation of End value

Pressing the "▼ Down" key will re-enter to the " Input End value edit" mode.

Pressing the "▲ Up" key will confirm end value of Input and

advance to the Start value of Input selection (section 3.1.8.2).

3.1.8.2: Start Value of Input

This screen allows the user to set the Start value of Input.

The band of the start value that can be set depends upon system type & Transducer type selected.

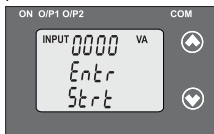

Start value can be set as follows :

1. 0 to 80% of end value for Apparent Power Transducer
2. -100% to 80% of end value for Active/Reactive Power Transducer
3. 0 to -175° for Phase angle Transducer. (Minimum span between

End value and start value is 20°)

4. -0.996 to 0.984 for Power factor Transducer.

Pressing the "▼ Down" key will enter into the "Start value edit" mode

Pressing "▲ Up" key will confirm the present value and then advance to the Elbow function selection (section 3.1.8.3)

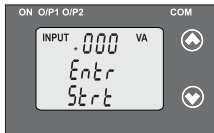

Editing Existing Start Value

(*Denotes that digit will be flashing). Pressing the "▼ Down" key will scroll the value of the first digit from 0 to 4 and value will roll back again to 0 or it will get restricted by set End value of Input.

Pressing the "▲ Up" key will advance the operation to the next digit and set the first digit, in this case to "0".

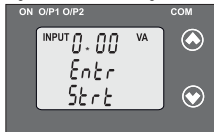

After first digit gets entered, it will prompt for second digit. (*Denotes that digit will be flashing). Pressing the "▼ Down" key will scroll the value of the second digit from 0 to 9, and value will roll back again to 0 or it will get restricted depending

on first digit set. Pressing the “^ Up” key will advance the operation to the next digit and set the second digit, in this case to “0”.



After second digit gets entered, it will prompt for third digit. (* denotes that digit will be flashing).

Pressing the “v Down” key will scroll from 0 to 9, and value will roll back again to 0 or it will get restricted depending on second digit set.

Pressing the “^ Up” key will advance the operation to Next digit and set the third digit, in this case to “5”.



After third digit gets entered, it will prompt for fourth digit. (* denotes that digit will be flashing).

Pressing the “v Down” key will scroll from 0 to 9, and value will roll back again to zero or it will get

restricted depending on third digit set.

Pressing the “^ Up” key will advance the operation to the “Input Start value confirmation” mode and set the fourth digit, in this case to “8”.



Confirmation of Start value

Pressing the “v Down” key will re-enter to the “Start value edit” mode.

Pressing the “^ Up” key will confirm Start value and advance to the Elbow function selection (section 3.1.8.3).

3.1.8.3: Elbow Function Selection

This screen allows the user to enable or disable Elbow function of input. This is applicable only for Active / Reactive / Apparent Transducer



Pressing the “**▼** Down” key will enter the “ Elbow enable or disable edit” mode and scroll the value between yes and no.

YES : Elbow function is enabled.
no : Elbow function is disabled.

Pressing “**▲** Up” key will accept the displayed condition .If Elbow function is enabled then transducer will advance to the Elbow value setting(section 3.1.8.4) otherwise advance to the output Characteristics selection(section 3.1.9).



Elbow enable/disable confirmation

Pressing “**▼** Down” key will re-enter into Elbow enable / disable Edit mode. Pressing “**▲** Up” key will confirm the displayed condition and if enabled then will advance to the Elbow value of setting (section 3.1.8.4) otherwise

Output Characteristics selection(section 3.1.9).

3.1.8.4 Elbow value of Input

This screen appears only when Elbow is enabled. This screen allows user to set Elbow value in-between (start value set+(0.015*End value set)) and 98.5 % of the end value set.



Pressing the “**▼** Down” key will enter into the “Input Elbow value edit” mode. Pressing “**▲** Up” key will confirm the present value as Elbow value of the Input and advance to the Output characteristics selection(section 3.1.9).



Editing Existing Elbow value

(*Denotes that digit will be flashing).
Pressing the “▼ Down” key will scroll the value of the first digit from 0 to 5 and value will roll back again to 0 or it will gets restricted depending upon start & end values set.

Pressing the “▲ Up” key will advance the operation to the next digit and set the first digit, in this case to “3”.

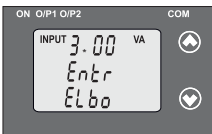

After first digit gets entered, it will prompt for second digit.
(*Denotes that digit will be flashing).
Pressing the “▼ Down” key will scroll the value of the second digit from 0 to 9 and value will roll back again to 0 or it will gets

restricted depending on first digit set.

Pressing the “▲ Up” key will advance the operation to the next digit and set the second digit, in this case to “0”.

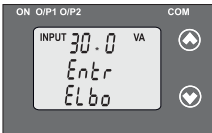

After second digit gets entered, it will prompt for third digit.
(*Denotes that digit will be flashing).

Pressing the “▼ Down” key will scroll the value of the third digit from 0 to 9 and value will roll back again to 0 or it will gets restricted depending on second digit set.

Pressing the “▲ Up” key will advance the operation to the next digit and set the third digit, in this case to “6”.



After third digit gets entered, it will prompt for fourth digit. (*Denotes that digit will be flashing). Pressing the “▼ Down” key will scroll the value of the fourth digit from 0 to 9 and value will roll back again to 0 or it will gets restricted

depending on third digit set.

Pressing the “▲ Up” key will advance the operation to the “elbow value Confirmation” mode and set the fourth digit, in this case to “6”.

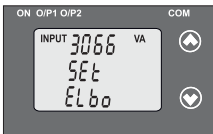

Confirmation of Elbow value

Pressing the “▼ Down” key will re-enter to the “Elbow value edit mode”. Pressing the “▲ Up” key will confirm Elbow value and advance to the output characteristics Selection (section 3.1.9).

3.1.9: Output Characteristics Setting

3.1.9.1: Output 1 Characteristics Setting

3.1.9.1.1: End value of output 1

This screen will only appear to show output1 End value .It's not editable. The End value of Current Output should be 20mA & Voltage output should be 10 V or depends upon user specified factory setting.



Pressing “▼ Down” key value remains constant because End value is fixed.

Pressing “▲ Up” key will confirm the present value as End value of the Output 1 and advance to the Start value of Output 1(section 3.1.9.1.2).

3.1.9.1.2: Start value of output 1

This screen allows the user to set the Start value of Output 1, (considered as DC Current). Start value of output 1 can be set upto 20 % of end value of output & minimum Start value setting depends upon transducer type. For Apparent transducer range of Start value setting can be done is 0 to 20% of End value.

For active/reactive/power factor/phase angle transducer range of Start value setting can be done is -100% to 20% of End value.



Pressing the "▼ Down" key will enter the " output 1 Start value edit" mode.

Pressing "▲ Up" key will confirm the present value as Start value and advance to the selection of Elbow value of output 1 if elbow

function of input is enabled (section 3.1.9.1.3)

Otherwise goes to output 2 characteristics selection(section 3.1.9.2)



Editing Existing Start value

(*Denotes that digit will be flashing).

Pressing the "▼ Down" key will not affect the first digit It always remains 0.

Pressing the "▲ Up" key will advance the operation to the next

digit and set the first digit, in every case to "0".



After first digit gets entered, it will Prompt for second digit.
(*Denotes that digit will be flashing).

Pressing the "▼ Down" key will scroll the value of the second digit from 0 to 4 and value will roll back again to 0 or it will get restricted by output End value.

Pressing the "▲ Up" key will advance the operation to the next digit and set the second digit, in this case to "4".



After second digit gets entered, it will prompt for third digit.

Pressing the "▼ Down" key will scroll the value of the third digit from 0 to 9 and value will roll back again to 0 or it will get restricted depending on second digit set.

Pressing the "▲ Up" key will advance the operation to the next digit and set the third digit, in this case to "0".



After third digit gets entered, it will Prompt for fourth digit

Pressing the "▼ Down" key will scroll the value of the fourth digit from 0 to 9 and it will roll back again to 0 or it will get restricted depending

on third digit set.

Pressing the "▲ Up" key will advance the operation to the "confirmation of Output 1 start value" and set the fourth digit, in this case to "0".



Confirmation of Start value

Pressing the "▼ Down" key will re-enter to the " Output 1 Start value edit "mode..

Pressing the "▲ Up" key will confirm Start value and advance to the selection of Elbow value of Output

(section 3.1.9.1.3) if input elbow is enabled or output 2 characteristics setting(section 3.1.9.3)

3.1.9.1.3: Elbow value of output 1

This screen appears only when Elbow is enabled. This screen allows user to set Elbow value in-between start value and end value set.



Pressing the "▼ Down" key will enter the " Output 1 Elbow value edit" Mode.

Pressing "▲ Up" key will set the present value as Elbow value of the Output 1 and advance to the Output

2 Characteristics selection(section 3.1.9.3).



Editing Existing Elbow value

(*Denotes that digit will be flashing).

Pressing the "▼ Down" key will scroll the value of the first digit from 0 to 2 and it will roll back again to 0 or it will get restricted by start value and End

value set . Pressing the "▲ Up" key will advance the operation to the next digit and set the first digit, in this case to "1".



After first digit gets entered, it will prompt for second digit.
(*Denotes that digit will be flashing).
Pressing the "▼ Down" key will scroll the value of the second digit from 0 to 9 and it will roll back again to 0 or it will get restricted depending on

first digit set.

Pressing the "▲ Up" key will advance the operation to the next digit and set the second digit, in this case to "6".



After second digit gets entered, it will prompt for third digit.
Pressing the "▼ Down" key will scroll the value of the third digit from 0 to 9 and it will roll back again to 0 or it will get restricted depending on

second digit set.

Pressing the "▲ Up" key will advance the operation to the next digit and set the third digit, in this case to "0".



After third digit gets entered, it will prompt for fourth digit.
Pressing the "▼ Down" key will scroll the value of the fourth digit from 0 to 9 and it will roll back again to 0 or it will get restricted depending

on third digit set.

Pressing the "▲ Up" key will advance the operation to the " Output 1 Elbow value confirmation "mode and set the fourth digit, in this case to "0".



Confirmation of Elbow value

Pressing the “▼ Down” key will re-enter into the “ Elbow value edit” mode.

Pressing the “▲ Up” key will confirm Elbow value and advance to the Output 2 characteristics selection(section 3.1.9.2).

3.1.9.2: Output 2 Characteristics Setting

3.1.9.2.1: End value of output 2

This screen will only appear to show output End value of Output 2. It's not editable. The End value of Current Output should be 20mA & Voltage output should be 10 V.



Pressing “▼ Down” key value remains constant because output 2 End value is fixed.

Pressing “▲ Up” key will confirm the present value as End value and advance to the Start value of Output 2 (section 3.1.9.2.2).

3.1.9.2.2: Start value of output 2

This screen allows the user to set the Start value of Output. For Apparent transducer range of Start value setting can be done is 0 to 20% of End value. For active/reactive/power factor/phase angle transducer range of Start value setting can be done is -100% to 20% of End value.



Pressing the “▼ Down” key will enter the “Output 2 Start value edit” mode.

Pressing “ ▲ Up” key will confirm the present value as Start value of the Output 2 and advance to the

Elbow value of Output 2 selection (section 3.1.9.2.3) if elbow function of input is enabled otherwise advance to the Mode selection (section 3.1.9).



Editing Existing Start value

(*Denotes that digit will be flashing). Pressing the “▼ Down” key will not affect the value of first digit, it is always 0.

Pressing the “▲ Up” key will advance the operation to the next digit and

set the first digit, in every case to “0”.



After, first digit gets entered, it will prompt for second digit.

(*Denotes that digit will be flashing).

Pressing the “▼ Down” key will scroll the value of the second digit from 0 to 9 and it will roll back again to 0 or it will get restricted by end value set.

Pressing the “▲ Up” key will advance the operation to the next digit and set the second digit, in this case to “0”.



After, second digit gets entered, it will prompt for third digit.

(*Denotes that digit will be flashing).

Pressing the “▼ Down” key will scroll the value of the third digit from 0 to 9 and it will roll back again to 0 or it will get restricted depending

on second digit set.

Pressing the “▲ Up” key will advance the operation to the next digit and set the third digit, in this case to “0”.



After, third digit gets entered, it will prompt for fourth digit. (*Denotes that digit will be flashing). Pressing the "▼ Down" key will scroll the value of the fourth digit from 0 to 1 and it will roll back again to 0 or it will get restricted depending

on third digit set.

Pressing the "▲ Up" key will advance the operation to the " Output 2 Elbow value confirmation " mode and set the fourth digit, in this case to "0".



Confirmation of Start value

Pressing the "▼ Down" key will re-enter to the "Output 2 Start value edit " mode.

Pressing the "▲ Up" key will confirm Output 2 Start value and advance to the Elbow value of Output 2

selection (section 3.1.9.2.3) if input elbow is enable or Mode Selection (section 3.1.10).

3.1.9.2.3: Elbow value of output 2

This screen appears only when Output 2 Elbow is enabled. This screen allows user to set Elbow value in-between start value and end value set.



Pressing the "▼ Down" key will enter the " Output 2 Elbow value edit " mode.

Pressing "▲ Up" key will confirm the present value as Elbow value and advance to the Mode Selection (section 3.1.10).



Editing Existing Elbow value

(*Denotes that digit will be flashing).

Pressing the "▼ Down" key will scroll the value of the first digit from 0 to 1 and it will roll back again to 0 or it will get restricted by End

value and start value set.

Pressing the "▲ Up" key will advance the operation to the next digit and set the first digit, in this case to "0".



After, first digit gets entered, it will prompt for second digit.

(*Denotes that digit will be flashing).

Pressing the "▼ Down" key will scroll the value of the second digit from 0 to 9 and it will roll back again to 0 or it will get restricted depending

on first digit set.

Pressing the "▲ Up" key will advance the operation to the next digit and set the second digit, in this case to "6".



After, second digit gets entered, it will prompt for third digit.

(*Denotes that digit will be flashing).

Pressing the "▼ Down" key will scroll the value of the third digit from 0 to 9 and it will roll back again to 0 or it will get restricted

depending on second digit set.

Pressing the "▲ Up" key will advance the operation to the next digit and set the third digit, in this case to "5".



After, third digit gets entered, it will prompt for fourth digit.
 (*Denotes that digit will be flashing).
 Pressing the "▼ Down" key will scroll the value of the fourth digit from 0 to 9 and it will roll back again to 0 or it will get restricted

depending on third digit set.

Pressing the "▲ Up" key will advance the operation to the " Elbow value Confirmation" mode and set the fourth digit, in this case to "0".



Confirmation of Elbow value

Pressing the "▼ Down" key will re-enter to the "Output 2 Elbow value edit " mode.

Pressing the "▲ Up" key will confirm Elbow value and advance to Mode Selection (Section 3.1.10).

3.1.10: Mode Selection:



This screen allows the user to set Mode Selection. Normal mode : Only Input & Output parameters are displayed. Diagnosis mode : All 3X measured parameters are displayed.
 Pressing the "▼ Down" key will enter into the "Mode Selection edit" mode and scroll between

nor: Normal Mode and **DIA:** Diagnosis Mode and will roll back again to Normal mode. Pressing "▲ Up" key will confirm the present mode as operating mode and exit the setup menu.

Note: After power ON / OFF Transducer goes by default to normal mode.



Mode confirmation

Pressing "▼ Down" key will be re-enter into the. "Mode selection edit" mode.

Pressing the "▲ Up" key will confirm the operating mode and exit the setup menu.

3.2: Programming Via Programming Port available at front of Transducers using optional PRKAB601 Adapter.

For programming of transducer, steps to be followed are

Connections

PC → PRKAB 601 → Transducer.

The power supply must be applied to transducer before it can be programmed.

The Configuration software is supplied on a CD along with software help file .

The programming cable PRKAB601 adjusts the signal level and provides the electrical insulation between the PC and Transducers. Configuration software can be used to program following parameter

- 1) PT ratio.
- 2) CT ratio.
- 3) RS485 parameters.
- 4) Transducer type.
- 5) System type.
- 6) Output type (along with DIP switch setting).
- 7) Input Characteristics.
- 8) Output Characteristics.

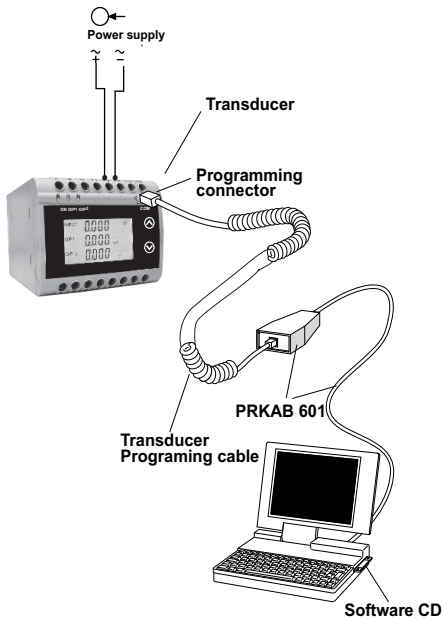

3.3 Programming Via optional RS485 (MODBUS) communication port.

(Refer section 4 for programming through MODBUS)

3.3.1: DIP Switch Setting for Changing Output type

The Transducer output type can be changed from DC current to DC voltage depending upon user requirement on site.

To change output type user has to set the transducer output type parameter either to voltage or current along with DIP switch setting.

The transducer output type parameters can be configured using one of the three below given methods.

A) PRKAB 601(optional) : Using PRKAB601 through Transducer programming port (COM) and using PC based configuration software.

B)Frontdisplay(optional):Using front display user can enter into programming mode and can change the output type.

C) Modbus Rs485(optional): Using Modbus interface user can configure the output type refer Modbus Rs485 section.

Note: If DIP switch setting is done first and then output type parameter is configured using either of the above three methods then switch OFF - ON the Transducer.

For changing DIP switches follow these steps

1) To change O/P switches from Current to Voltage or vice versa, ensure that transducer should be Electrically dead and all connection wires should be disconnected.

2) Remove the back cover of Transducer by using screw driver.

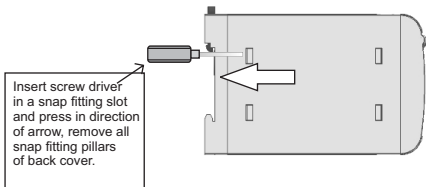

3) Remove the back cover and take the Output card out.

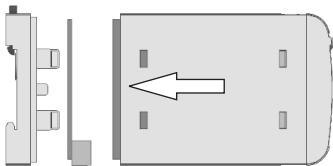

4) Configure the switches for Voltage or Current as shown below.

DIP Switch Setting	Type of Output Signal
<p>ON 1234</p>	load-independent Voltage
<p>ON 1234</p>	load-independent Current

Note : Black portion in this diagram indicates switch position.

Switches for setting output 2 type to Voltage or Current.

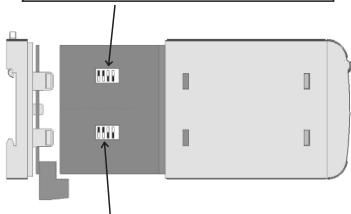

Switches for setting output 1 type to Voltage or Current.

NOTE:

Black portion in above diagram indicate switch position.

- 5) After changing the switches for desired Output, Insert the Output Card.

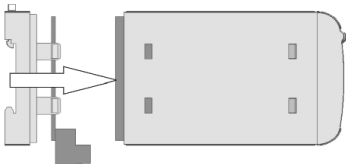

Insert the output card, press in direction of arrow.

6) After inserting the output card insert the Interface card PCB and back cover.

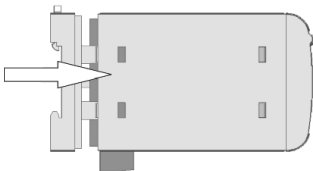

Insert the Interface card PCB and Back cover,
press in direction of arrow.

7) After inserting the Back cover of transducer, transducer is ready for required application.

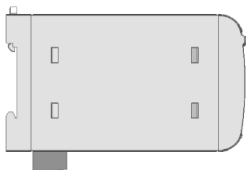

4. RS 485 (Modbus)

Transducer supports MODBUS (RS485) RTU protocol (2-wire).

Connection should be made using twisted pair shielded cable. All "A" and "B" connections are daisy chained together. The screens should also be connected to the "Gnd" terminal. To avoid the possibility of loop currents,

an Earth connection should be made at one point on the network. Loop (ring) topology does not require any termination load. Line topology may or may not require terminating loads depending on the type and length of cable used. The impedance of the termination load should match the impedance of the cable and be at both ends of the line. The cable should be terminated at each end with a 120 ohm (1/4 Watt min.) resistor.

RS 485 network supports maximum length of 1.2km. Including the Master, a maximum of 32 instruments can be connected in RS485 network. The permissible address range for Power Transducer is between 1 and 247 for 32 instruments. Broadcast Mode (address 0) is not allowed.

The maximum latency time of a Transducer is 200ms i.e. this is the amount of time that can pass before the first response character is output.

After sending any query through software (of the Master), it must allow 200 ms of time to elapse before assuming that the Transducer is not going to respond. If slave does not respond within 200 ms, Master can ignore the previous query and can issue fresh query to the slave.

The each byte in RTU mode has following format:

	8-bit binary, hexadecimal 0-9, A-F 2 hexadecimal characters contained in each 8-bit field of the message
Format of Data Bytes	4 bytes (32 bits) per parameter. Floating point format (to IEEE 754) Most significant byte first (Alternative least significant byte first)
Error Checking Bytes	2 byte Cyclical Redundancy Check (CRC)

Byte format	1 start bit, 8 data bits, least significant bit sent first 1 bit for even/odd parity 1 stop bit if parity is used; 1 or 2 bits if no parity
--------------------	---

Communication Baud Rate is user selectable from the front panel between 2400, 4800, 9600, 19200 bps.

Function code :

03	Read Holding Registers	Read content of read /write location (4X)
04	Read input Registers	Read content of read only location (3X)
16	Presets Multiple Registers	Set the content of read / write locations (4X)

Exception Cases : An exception code will be generated when Transducer receives Modbus query with valid parity & error check but which contains some other error (e.g. Attempt to set floating point variable to an invalid value) The response generated will be "Function code" ORed with HEX (80H). The exception codes are listed below

01	Illegal function	The function code is not supported by Power Transducer.
02	Illegal Data Address	Attempt to access an invalid address or an attempt to read or write part of a floating point value
03	Illegal Data Value	Attempt to set a floating point variable to an invalid value

4.1 Accessing 3 X register for reading measured values:

Two consecutive 16 bit registers represent one parameter. Refer table 2 for the addresses of 3X registers (Parameters measured by the instruments).

Each parameter is held in the 3X registers. Modbus Code 04 is used to access all parameters.

Example :

To read parameter,

Active power sum : Start address= 34 (Hex) Number of registers = 02

Note : Number of registers = Number of parameters x 2

Each Query for reading the data must be restricted to 20 parameters or less. Exceeding the 20 parameter limit will cause a Modbus exception code to be returned.

Query :

01 (Hex)	04 (Hex)	00 (Hex)	34(Hex)	00 (Hex)	02(Hex)	30 (Hex)	05 (Hex)
Device Address	Function Code	Start Address High	Start Address Low	Number of Registers Hi	Number of Registers Lo	CRC Low	CRC High

Start Address High : Most significant 8 bits of starting address of the parameter requested.

Start Address low : Least significant 8 bits of starting address of the parameter requested.

Number of register Hi : Most significant 8 bits of Number of registers requested.

Number of register Lo : Least significant 8 bits of Number of registers requested.

(Note : Two consecutive 16 bit register represent one parameter.)

Response: Active Power Sum (4331 W)

01 (Hex)	04 (Hex)	04 (Hex)	45 (Hex)	87 (Hex)	68 (Hex)	B5 (Hex)	B0 (Hex)	D6 (Hex)
Device Address	Function Code	Byte Count	Data Register1 High Byte	Data Register1 Low Byte	Data Register2 High Byte	Data Register2 Low Byte	CRC Low	CRC High

Byte Count : Total number of data bytes received.

Data register 1 High Byte : Most significant 8 bits of Data register 1 of the parameter requested.

Data register 1 Low Byte : Least significant 8 bits of Data register 1 of the parameter requested.

Data register 2 High Byte : Most significant 8 bits of Data register 2 of the parameter requested.

Data register 2 Low Byte : Least significant 8 bits of Data register 2 of the parameter requested.

(Note : Two consecutive 16 bit register represent one parameter.)

Table 2 : 3 X register addresses (measured parameters)

Address (Register)	Parameter No.	Parameter	Modbus start address Hex	
			High Byte	Low Byte
For Active power				
30053	27	Active power sum	0	34
For Apparent power				
30057	29	Apparent power sum	0	38
For Reactive power				
30061	31	Reactive power sum	0	3C
For Power factor				
30063	32	Power factor average	0	3E
For Phase angle				
30067	34	Phase angle average	0	42

For Diagnosis mode only

Address (Register)	Parameter No.	Parameter	Modbus start address Hex	
			High Byte	Low Byte
30001	1	voltage 1	0	0
30003	2	voltage 2	0	2
30005	3	voltage 3	0	4
30007	4	current 1	0	6
30009	5	current 2	0	8
30011	6	current 3	0	0A
30043	22	voltage average	0	2A
30047	24	current average	0	2E
30071	36	frequency	0	46
30073	37	VL1-2	0	48
30075	38	VL2-3	0	4A
30077	39	VL3-1	0	4C

4.2 Accessing 4 X register for Reading & Writing:

Each setting is held in the 4X registers .Modbus code 03 is used to read the current setting and code 16 is used to write/change the setting. Refer **Table 3** for 4 X Register addresses.

Example : Reading Device address

Device address : Start address = 0E (Hex) Number of registers = 02

Note :Number of registers = Number of Parameters x 2

Query :

Device Address	01 (Hex)
Function Code	03 (Hex)
Start Address High	00 (Hex)
Start Address Low	0E(Hex)
Number of Registers Hi	00 (Hex)
Number of Registers Lo	02 (Hex)
CRC Low	A5 (Hex)
CRC High	C8 (Hex)

Start Address High : Most significant 8 bits of starting address of the parameter requested.

Start Address low : Least significant 8 bits of starting address of the parameter requested.

Number of register Hi : Most significant 8 bits of Number of registers requested.

Number of register Lo : Least significant 8 bits of Number of registers requested.

(Note : Two consecutive 16 bit register represent one parameter.)

Response: Device address (1)

Device Address	01 (Hex)
Function Code	03 (Hex)
Byte Count	04 (Hex)
Data Register1 High Byte	3F (Hex)
Data Register1Low Byte	80 (Hex)
Data Register2 High Byte	00 (Hex)
Data Register2 Low Byte	00(Hex)
CRC Low	F7 (Hex)
CRC High	CF (Hex)

- Byte Count : Total number of data bytes received.
- Data register 1 High Byte : Most significant 8 bits of Data register 1 of the parameter requested.
- Data register 1 Low Byte : Least significant 8 bits of Data register 1 of the parameter requested.
- Data register 2 High Byte : Most significant 8 bits of Data register 2 of the parameter requested.
- Data register 2 Low Byte : Least significant 8 bits of Data register 2 of the parameter requested.
- (Note : Two consecutive 16 bit register represent one parameter.)**

Table 3 : 4 X register addresses

Address (Register)	Parameter No.	Parameter	Read / Write	Modbus Start Address Hex	
				High Byte	Low Byte
40001	1	-	-	-	-
40003	2	Mode selection	R/Wp	00	02
40005	3	System Type	R/Wp	00	04
40007	4	PT Primary	R/Wp	00	06
40009	5	PT Secondary	R/Wp	00	08
40011	6	CT Primary	R/Wp	00	0A
40013	7	CT Secondary	R/Wp	00	0C
40015	8	Device address	R/Wp	00	0E
40017	9	RS 485 Setup	R/Wp	00	10
40019	10	Password	R/Wp	00	12
40021	11	-	-	-	-
40023	12	-	-	-	-
40025	13	-			

Address (Register)	Parameter No.	Parameter	Read / Write	Modbus Start Address Hex	
				High Byte	Low Byte
40027	14	Sim_Output A	Wp	00	1A
40029	15	Sim_Output B	Wp	00	1C
40031	16	Analog O/P Type 1	R/Wp	00	1E
40033	17	Output para select 1	R/Wp	00	20
40035	18	Analog O/P Type 2	R/Wp	00	22
40041	19	Diagnosis Mode	R/Wp	00	28

Explanation for 4 X register :

Address	Parameter	Description
40003	Output Mode Selection	<p>This is used to select the output mode. By setting output in simulation mode user can simulate the output variation without giving input. Normal mode = 1. Simulation mode = 2.</p> <p>Note: After power ON / OFF Transducer goes to normal mode</p>
40005	System Type	<p>This is used to select the system type.</p> <p>For Apparent / Active / Reactive Power Transducer</p> <ol style="list-style-type: none"> 1) 3 Phase 3 wire unbalanced = 3. 2) 3 Phase 4 wire unbalanced = 4. 3) Single Phase = 1. 4) 3 Phase 4 wire balanced = 8. 5) 3 Phase 3 wire balanced = 2. <p>For Phase Angle or Power Factor Transducer</p> <ol style="list-style-type: none"> 1) U12 I1 (3 Phase 3 wire balanced) = 5. 2) U23 I1 (3 Phase 3 wire balanced) = 6. 3) U31 I1 (3 Phase 3 wire balanced) = 7.

Address	Parameter	Description
		4) Single Phase = 1. 5) 3 Phase 4 wire balanced = 8. 6) 3 Phase 3 wire balanced = 2.
40007	PT Primary	This address allows the user to read and write PT Primary value. The PT Primary value can be set between 100 to 692.8 KVLL and also depends upon the per phase 1000 MVA Restriction of power combined with CT Primary.
40009	PT Secondary	This address is used to read and write the PT secondary value in range between 100V to 500V L-L.
40011	CT Primary	This address allows the user to read and write CT Primary value. The maximum settable value is 9999 & also depends on the per phase 1000 MVA Restriction of power combined with PT primary.
40013	CT Secondary	This address is used to read and write the CT secondary value in range between 1A to 5A.
40015	Device Address	This address is used to set the Device Address between 1 to 247.
40017	RS 485 Setup	This address is used to set the Baud rate, Parity, No of Stop bits.
40019	Password	This address is used to set & reset the password. Valid Range of Password can be set is 0000 - 9999. 1) if password lock is present & if this location is read it will return zero.

Address	Parameter	Description
		2) if pass word lock is absent & if this location is read it will return one. 3) if password lock is present & to disable this lock first send valid password to this location then write "0000" to this location.
40027	Sim_Output A	This address is used to simulate output1. Analog Output 1 can be set to 10% by writing a value1000 and can be set to 100% by writing a value 10000. Note: first transducers simulation mode is to be enable using address 40003.
40029	Sim_Output B	This address is used to simulate Output 2. Analog Output 2 can be set to 10% by writing a value1000 and can be set to 100% by writing a value 10000. Note: first transducers simulation mode is to be enable using address 40003.
40031	Analog O/P Type 1	This address is used to set the output 1 type as Voltage or Current. Voltage = 1. Current = 2.
40033	Output para Select	This address is used to set the Transducer type as 1) Active Power = 1. 2) Apparent Power = 2. 3) Reactive power = 3. 4) PF = 4. 5) Phase Angle = 5.

Address	Parameter	Description
		Note: For system type 3Ph3W unbalance and 3Ph4W unbalance, transducer type such as PF and Phase angle are not applicable where as for system type U12 I1,U23 I1 and U31 I1, Transducer type such as Active power, Reactive power and Apparent power are not applicable.
40035	Analog O/P Type 2	This address is used to set output 2 type as Voltage/Current. Voltage = 1. Current = 2.
40041	Diagnosis Mode	This address is used to set transducer into the Diagonosis or Normal mode. Normal mode = 0 Diagnosis mode =1. Note: After power ON / OFF Transducer goes to normal mode

Table 4 : RS 485 Set-up Code

Baud Rate	Parity	Stop Bit	Decimal value
19200	NONE	01	12
19200	NONE	02	13
19200	EVEN	01	14
19200	ODD	01	15
9600	NONE	01	08
9600	NONE	02	09
9600	EVEN	01	10

Baud Rate	Parity	Stop Bit	Decimal value
9600	ODD	01	11
4800	NONE	01	04
4800	NONE	02	05
4800	EVEN	01	06
4800	ODD	01	07
2400	NONE	01	00
2400	NONE	02	01
2400	EVEN	01	02
2400	ODD	01	03

Note :

Codes not listed in the table above may give rise to unpredictable results including loss of communication. Exercise caution when attempting to change mode via direct Modbus writes.

5. Phaser Diagram :

Quadrant 1: 0° to 90°

Quadrant 3: 180° to 270°

Quadrant 2: 90° to 180°

Quadrant 4: 270° to 360°

Quadrant	Sign of Active Power (P)	Sign of Reactive Power (Q)	Sign of Power Factor (PF)	Inductive / Capacitive
1	+ P	+ Q	+	L
4	+ P	- Q	+	C
2	- P	+ Q	-	C
3	- P	- Q	-	L

Inductive means Current lags Voltage

Capacitive means Current leads Voltage

Examples of measuring ranges with ϕ -linear output

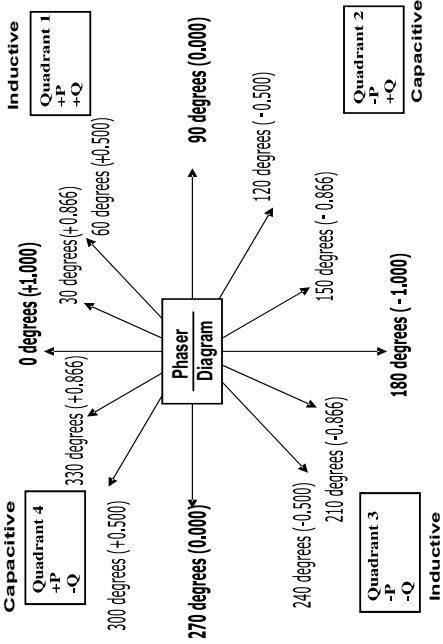

Examples of measuring ranges with Phase angle

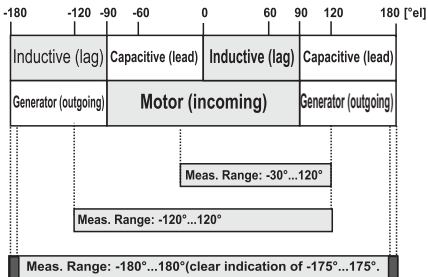

Examples of measuring ranges with $\cos\phi$

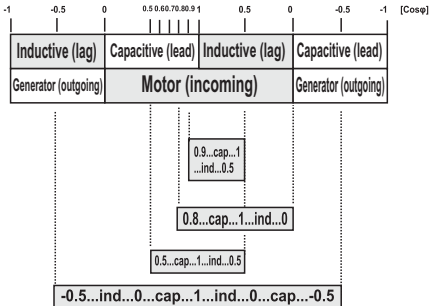

6. Installation

Transducer can be mounted either on a top-hat rail or directly on to a wall by a mounting plate.



As the front of the enclosure conforms to IP 40. The terminals of the product should be protected from liquids.

The Transducer should be mounted in a reasonably stable ambient temperature and where the operating temperature is within the range 0 to 45 °C. Vibration should be kept to a minimum and the product should not be mounted where it will be subjected to excessive direct sunlight.

Caution

1. In the interest of safety and functionality this product must be installed by a qualified engineer, abiding by any local regulations.
2. Voltages dangerous to human life are present at some of the terminal connections of this unit. Ensure that all supplies are de-energised before attempting any connection or disconnection.
3. These products do not have internal fuses therefore external fuses must be used to ensure safety under fault conditions.

6.1: EMC Installation Requirements

This product has been designed to meet the certification of the EU directives when installed to a good code of practice for EMC in industrial environments, e.g.

1. Screened output and low signal input leads or have provision for fitting RF suppression components, such as ferrite absorbers, line filters etc., in the event that RF fields cause problems.

Note: It is good practice to install sensitive electronic instruments that are performing critical functions, in EMC enclosures that protect against electrical interference which could cause a disturbance in function.

2. Avoid routing leads alongside cables and products that are, or could be, a source of interference.
3. To protect the product against permanent damage, surge transients must be limited to 2kV pk. It is good EMC practice to suppress differential surges to 2kV at the source. The unit has been designed to automatically recover in the event of a high level of transients. In extreme circumstances it may be necessary to temporarily disconnect the auxiliary supply for a period of greater than 5 seconds to restore correct operation. The Current inputs of these products are designed for connection in to systems via Current Transformers only, where one side is grounded.
4. ESD precautions must be taken at all times when handling this product.

6.2: Case Dimension

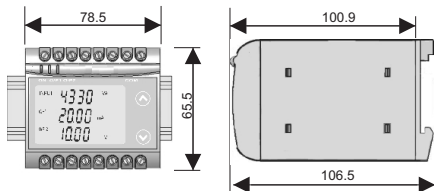

6.3: Wiring

Input connections are made directly to screw-type terminals with indirect wire pressure. Choice of cable should meet local regulations. Terminal for both Current and Voltage inputs will accept up to 4.0 mm single wire or 2 x 2.5 mm fine wire.

6.4: Auxiliary Supply

Transducer should ideally be powered from a dedicated supply, however it may be powered from the signal source, provided the source remains within the limits of the chosen auxiliary voltage. A switch or circuit, may be used in close proximity to the equipment & within easy reach of the OPERATOR & It shall be marked as the disconnecting device for the equipment.

6.5: Fusing

It is recommended that all voltage lines are fitted with 1 amp HRC fuses.

6.6: Earth/Ground Connections

For safety reasons, CT secondary connections should be grounded in accordance with local regulations.

6.7: Maintenance

No maintenance is required.

7. Specifications

Measured Parameter → Active Power / Reactive Power / Apparent Power / Power Factor /Phase Angle.

Network Type Supported for Power : Single Phase /
3 Phase 3 wire Unbalanced load/
3 Phase 4 wire Unbalanced load/
3 Phase 3 wire balanced load/
3 Phase 4 wire balanced load.

Network Type Supported for Power Factor & Phase Angle : Single Phase /
(U12 I1) 3 Phase Balanced load /
(U31 I1) 3 Phase Balanced load /
((U23 I1) 3 Phase Balanced load /
3 phase 3 wire balanced load/
3 phase 4 wire balanced load.

Nominal Voltage Input(U_N)

Nominal input Voltage (AC RMS) (PT Secondary range)	$100 \text{ V} \leq U_N \leq 500 \text{ VL-L}$
PT Primary range	100V to 692.8 KVL-L
Nominal Frequency F_N	25 to 65 Hz
Nominal input Voltage burden	$< 0.6 \text{ VA}$ per phase at U_N
Overload Capacity	$1.2 * U_N$ continuously, $2 * U_N$ for 1 second, repeated 10 times at 10 minute intervals But maximum $300V_{L-N}$ with Aux supply powered from measuring input.

Nominal Current Input(I_N):

Nominal input current (AC RMS) (CT Secondary range)	$1 \text{ A} \leq I_N \leq 5 \text{ A}$
CT Primary range	1 A to 9999 A
Nominal Frequency F_N	25 to 65 Hz
Nominal input Current burden	$< 0.2 \text{ VA}$ per phase at I_N
Overload Capacity	$1.2 * I_N$ continuously, $10 * I_N$ for 3 second, repeated 5 times at 5 minute intervals. $50 * I_N$ for 1 second, repeated 1 times at 1 hour interval(But max 250 A).

Allowed measuring range end values X2 (calibration factor Xc):

With single phase AC Active / Reactive / Apparent Power

$$[0.3 \leq (X2 / \text{Rated Power}) \leq 1.3] \cdot (U_N \cdot I_N / 3)$$

With 3-phase AC Active / Reactive / Apparent Power

$$[0.3 \leq (X2 / \text{Rated Power}) \leq 1.3] \cdot (3 \cdot U_N \cdot I_N)$$

(For single phase Rated Power = $U_N \cdot I_N / 3$)(For Three phase Rated Power = $3 \cdot U_N \cdot I_N$)**Phase Angle & Power Factor measuring Range:**

Minimum span 20° to Maximum Span 350°

Auxiliary:

AC/DC Auxiliary Supply	60V.....300 VAC-DC $\pm 5\%$ 24V.....60 VAC-DC $\pm 10\%$
Aux. Supply frequency range	40 to 65 Hz
Auxiliary Supply consumption	

60V.....300 VAC-DC	$\leq 8\text{VA}$ for one output
	$\leq 10\text{VA}$ for two outputs
24V.....60 VAC-DC	$\leq 5\text{VA}$ for one output
	$\leq 6\text{VA}$ for two outputs

Measuring Output Y(Single or Optional Dual):

Output type Y2	Load independent DC Voltage , DC Current (On site selectable through DIP switches.)
Load independent DC output	Unipolar 0...20mA / 4...20mA OR 0...10V. Bipolar -20mA....0....+20mA OR -10V....0....+10V
Output burden with DC current output Signal	$0 \leq R \leq 15V/Y2$
Output burden with DC voltage output Signal	$Y2/(2 \text{ mA}) \leq R \leq \infty$
Current limit under overload R=0	$\leq 1.25 * Y2$ with current output $\leq 100 \text{ mA}$ with voltage output
Voltage limit under $R \leq \infty$	$< 1.25 * Y2$ with voltage output $\leq 30 \text{ V}$ with current output
Residual Ripple in Output signal	$\leq 1\% \text{ pk-pk}$
Response Time	$\leq 750 \text{ ms}$

Accuracy :(Acc. to IEC 60688)

Reference Value Output end Value Y2 (Voltage or Current)

Basic Accuracy for power transducer 0.2°C

Basic Accuracy for Phase

Angle & Power Factor transducer 0.5°C

Factor C (the highest value applies)

Linear characteristics:

$$C = \frac{1 - \frac{Y_0}{Y_2}}{1 - \frac{X_0}{X_2}} \text{ or } C = 1$$

$$\text{For } X_0 \leq X \leq X_1 \quad C = \frac{Y_1 - Y_0}{X_1 - X_0} \cdot \frac{X_2}{Y_2} \text{ or } C = 1$$

For $X_1 \leq X < X_2$

Bent characteristics:

$$C = \frac{1 - \frac{Y_1}{Y_2}}{1 - \frac{X_1}{X_2}} \text{ or } C = 1$$

Output characteristics:

1) Example of setting with Linear characteristics:

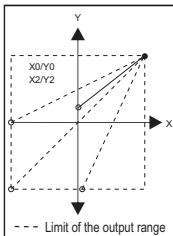

2) Example of setting with Bent characteristics:

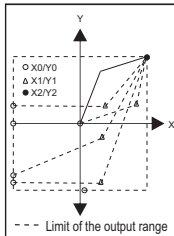

X0 = Start value of input Y0 = Start value of output
 X1 = Elbow value of input Y1 = Elbow value of output
 X2 = End value of input Y2 = End value of output
 R_N = Rated value of output burden U_N/I_N = Nominal input voltage/current

Reference conditions for Accuracy :

For Power Transducer:

Ambient temperature	23°C +/- 1°C
Pre-conditioning	30 min acc. to IEC EN - 60688
Input Variable	Rated Voltage / Rated Current Range
Input waveform	Sinusoidal, Form Factor 1.1107
Input signal frequency	50 or 60Hz
Active / Reactive / PF	Cos Φ =1 resp. Sin Φ = 1

For Phase Angle & Power Factor Transducer:

Reference Value	For Phase angle = 90° resp. For power factor = 0.5
-----------------	---

Auxiliary supply voltage	Rated Value
Auxiliary supply frequency	Rated Value
Output Load	$R_N = 7.5 \text{ V} / Y_2 \pm 1\%$ With DC current output signal $R_N = Y_2 / 1 \text{ mA} \pm 1\%$ With DC voltage output signal

Miscellaneous	Acc. to IEC - 60688
---------------	---------------------

Additional Error:

Temperature influence $\pm 0.2\%/10^{\circ}\text{C}$

Influence of Variations:

As per IEC EN-60688 standard.

Output stability <30min

Safety:

Protection IP 40, housing according to EN 60 529
IP 20, terminal according to EN 60 529

Pollution degree 2

Installation Category III

Insulation Voltage 1min. (EN 61 010-1)
7700V DC, Input versus outer surface
5200V DC, Input versus all other circuits
5200V DC, Auxiliary supply versus outer surface and output
690V DC, Output versus output versus each other versus outer surface.

Installation Data:

Mechanical Housing Lexan 940 (polycarbonate)
Flammability Class V-0 acc. To UL 94,
self extinguishing, non dripping, free of halogen

Mounting position Rail mounting / wall mounting

Weight Approx. 0.4kg

Connection Terminal:

Connection Element	Conventional Screw type terminal with indirect wire pressure
Permissible cross section the connection lead	$\leq 4.0 \text{ mm}^2$ single wire or $2 \times 2.5 \text{ mm}^2$ of Fine wire

Environmental:

Nominal range of use	0 °C... <u>23 °C</u> ... 45 °C(usage Group II)
Storage temperature	-40 °C to 70 °C
Relative humidity of annual Mean	$\leq 75\%$
Altitude	2000m max
Location	Indoor use

Ambient tests:

IEC 60 068-2-6	Vibration
Acceleration	$\pm 2 \text{ g}$
Frequency range	10....150...10Hz,
Rate of frequency sweep	1 octave/minute
Number of cycles	10, in each of the three axes
EN 60 068-2-7	Shock
Acceleration	3 x 50g 3 shocks in each direction
EN 60 068-2-1/-2/-3	Cold, Dry, Damp heat
IEC 61000/-3/-4/-5/-6 IEC 61326	Electromagnetic compatibility.

8. Connection Diagrams

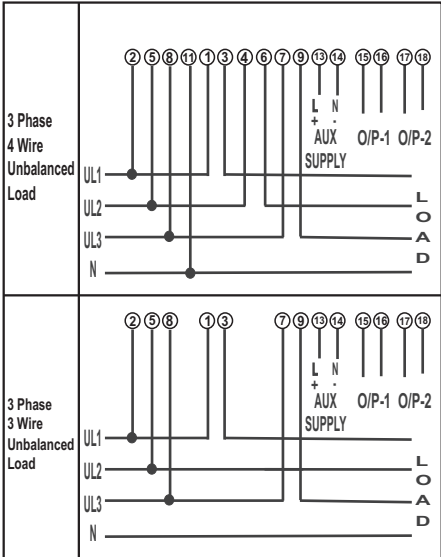

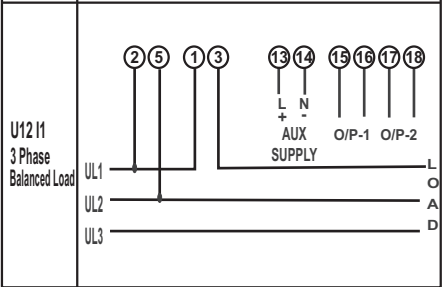
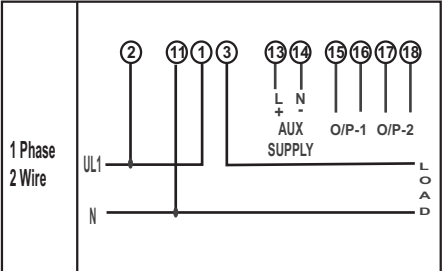

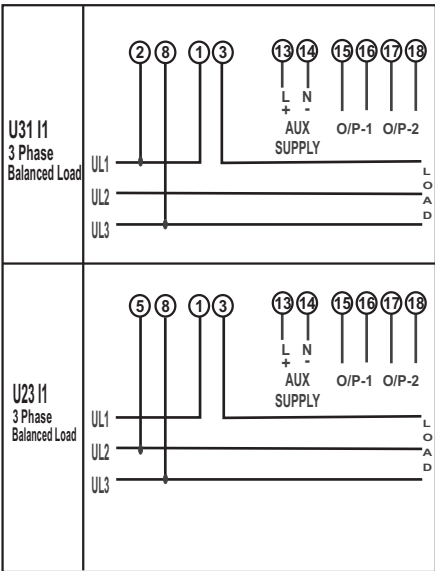

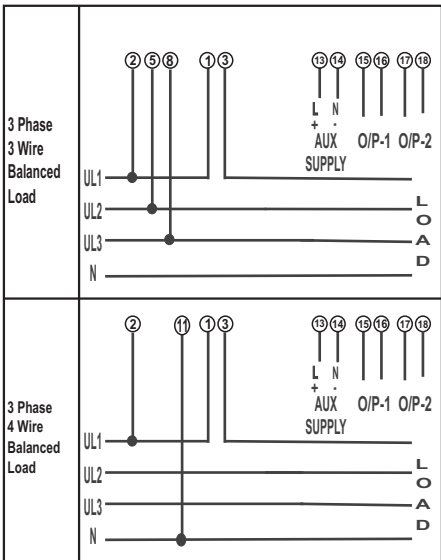

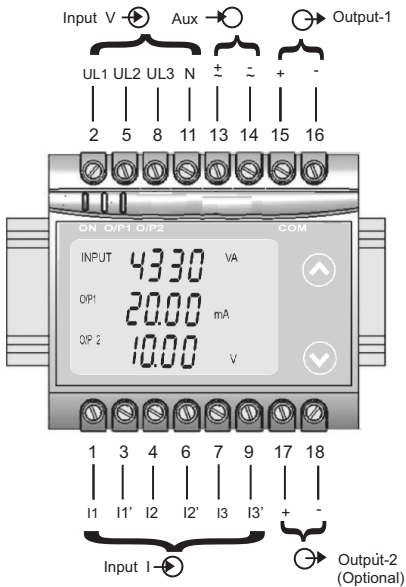

RS 485 Connection

RS 485		
B	A	G

Meaning of symbols on the instrument



Warning concerning a point of danger
(Attention:observe documentation)



Equipment protected through by
Double insulation or reinforced
insulation



DC voltage /Current



AC/DC voltage



Isolation between input versus all other
circuit is 3.7 KV.

NOTE

The Information contained in these installation instructions is for use only by installers trained to make electrical power installations and is intended to describe the correct method of installation for this product. It is the user's responsibility to determine the suitability of the installation method in the user's field conditions.

NOTE

NOTE



RISHABH
INSTRUMENTS

Measure, Control & Record with a Difference

RISHABH INSTRUMENTS PVT. LTD.

F-31, M.I.D.C., Satpur, Nashik 422 007, India.

Tel. : +91 253 2202162, 2202202,

Fax : +91 253 2351064

Email : marketing@rishabh.co.in

www.rishabh.co.in