



RISH DELTA POWER NX

With Touch Key



Measure



Control



Record



Analyze

RISH Delta Power measures important electrical parameters in 3 phase 4 wire, 3 phase 3 wire, 1 phase 2 wire and 1 phase 3 wire (split-phase) network. It displays many parameters at a glance. It measures electrical parameters like Active / Reactive / Apparent power and all basic parameter. The instrument has one optional built in relay output which can be configured as limit output. MODBUS RTU over RS-485 is built in for remote monitoring and configuration.

Product Features:

True RMS measurement:

- ▶ The instrument measures distorted waveform up to 15th harmonic

Front panel keys:

- ▶ Two keys are useful for easy setup navigation and changing setup parameters

Storage of parameters:

- ▶ The instrument stores minimum and maximum values of System Voltage, System Current, Power. Also Run Hour, On Hours, number of AUX interrupts and Max Demand are stored.

Display:

- ▶ 3 Line, 4 Digit bright Red LED display and indication LEDs
- ▶ Display can be configured for automatic scrolling of parameters or manual scrolling through 2 touch keys as per requirement and application of user.

On site programmable PT/CT ratios:

- ▶ It is possible to program primary, secondary of external potential transformer (PT) & primary, secondary of external current transformer (CT) via front panel keys and MODBUS.

MODBUS (RS485) Output:

- ▶ RS485 output enables the instrument to transmit all the Measured parameters over standard MODBUS protocol
- ▶ The instrument can be configured via MODBUS communication.

Demand:

- ▶ The Instrument integrates demand value for Active Power (kW), Apparent Power (kVA), Reactive Power (kVar) and Current (A).
- ▶ The demand integration time can be configured from 5 to 60 minutes.

Limit (Alarm) Output:

- ▶ Potential free 1NO contact
- ▶ Fully configurable trip point, hysteresis, on and off delays for Limit Output operation.



Low back depth:

- ▶ The instrument has low back depth (behind the panel) of 27mm.

Auxiliary supply:

- ▶ Higher Auxiliary power supply with voltage range 60V-300V AC/DC.
- ▶ Lower Auxiliary power supply with voltage range 20V-60V AC/DC.

Compliance to International Safety standards:

- ▶ Compliance to International Safety standard IEC 61010-1:2017

EMC Compatibility:

- ▶ Compliance to International standard IEC 61326

Datasheet subject to change without notice



Measure



Control



Record



Analyze

Dimensions Details:

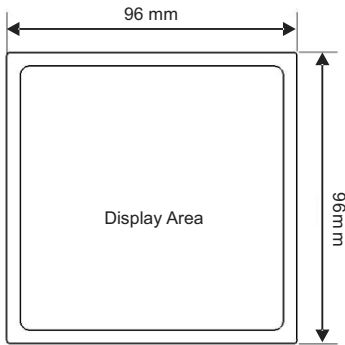

Front View

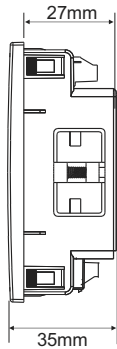

Side View

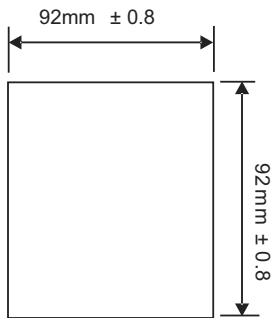

Panel Cutout

Technical Specifications:

Input Voltage:

Nominal input voltage (AC RMS)	288.68VLN (500VLL)
System PT secondary values	100VLL to 500VLL programmable on site.
System PT primary values	100VLL to 1200kVLL programmable on site. (1000MVA maximum power) (1200kVLL when CT primary ≤ 1002A)
Max continuous input voltage	120% of nominal value
Overload Indication	"-OL-" >121% of Nominal value
Nominal input voltage burden	< 0.1VA approx. per phase (at nominal 240V)
Overload Withstand:	2 x rated value for 1 second, repeated 10 times at 10 second intervals

Input Current:

Nominal input current	1A / 5A onsite programmable
System CT primary values	From 1A to 9999A (1000MVA maximum power) (9999A when PT primary ≤ 120kVLL)
Max continuous input current	120% of nominal value
Overload Indication	"-OL-" >121% of Nominal value
Nominal input current burden	< 0.3VA approx. per phase (at 5A)
Overload Withstand:	20 x rated value for 1 second, repeated 5 times at 5 minute intervals

Auxiliary Supply:

Higher Auxiliary supply range	60-300 V AC/DC (230V nominal)
Lower Auxiliary supply range	20-60 V AC/DC.
Aux Supply frequency	45 to 65 Hz range
Auxiliary Supply burden	< 4VA approx (230V nominal).

Operating Measuring Ranges:

Current	5 ... 120% of nominal value
Voltage	10 ... 120% of nominal value
Power Factor	0.5 Lag ... 1 ... 0.5 Lead
Frequency	40Hz to 70Hz

Reference Conditions for Accuracy

Reference temperature	23°C +/- 2°C
Influence of temperature	0.025%/°C for Voltage & 0.05%/°C for Current
Input Waveform	Sinusoidal (distortion factor 0.005)
Input frequency	50/60 Hz ± 2%
Voltage range	10... 120% of nominal Value
Current range	5 ... 120% of nominal Value
Power range	40 ... 120% of nominal Value of Voltage 10 ... 120% of nominal Value of Current
Power Factor/Phase Angle	40 ... 120% of nominal Value of Voltage 40 ... 120% of nominal Value of Current

Display update rate:

Response time to step input	1 sec approx.
-----------------------------	---------------

Datasheet subject to change without notice



Measure



Control



Record



Analyze

Electrical Connection:

Network Types :

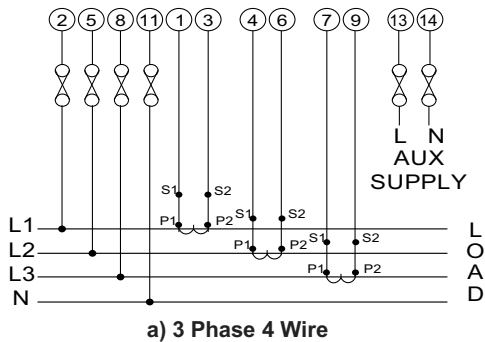

a) 3 Phase 4 Wire

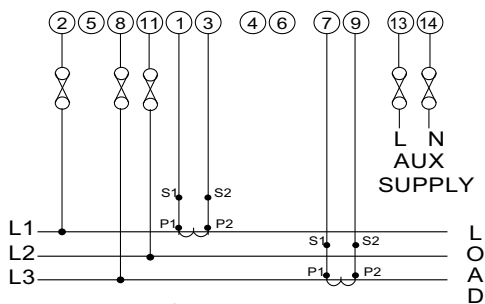

b) 3 Phase 3 Wire

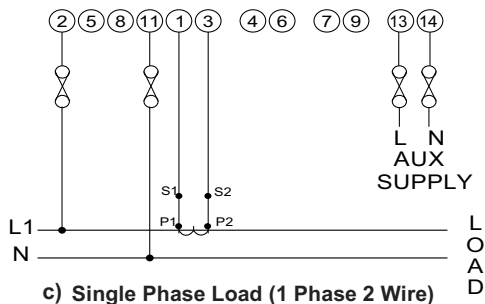

c) Single Phase Load (1 Phase 2 Wire)

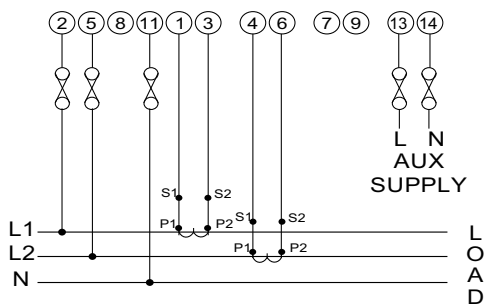

d) Split Phase (1 Phase 3 Wire)

It is recommended that the wires used for connections to the instrument should have lugs crimped at the end. That is, the connections should be made with Lugged wires for secure connections.

Technical Specifications:

Accuracy

Parameter	Accuracy Class 1.0
Voltage	± 0.5% of Nominal value
Current	± 0.5% of Nominal value
Frequency	± 0.1% of mid frequency
Active Power	± 1% of Nominal value
Re-Active Power	± 1% of Nominal value
Apparent Power	± 1% of Nominal value
Power Factor/ angle	±2°

Applicable Standards:

EMC	IEC 61326 - 1, Table 2
Immunity	IEC 61000-4-2, 4-3, 4-4, 4-5, 4-6, 4-8, 4-11
Emission	CISPR 11
Safety	IEC 61010-1:2017
IP for water & dust	IEC 60529

Isolation:

Pollution degree:	2
Installation category:	III
High voltage test	
All Circuit Vs Surface	3.5 kV RMS, 50Hz, 1min
Input / AUX Vs Others	3.3 kV RMS, 50Hz, 1min
Input Voltage Vs Input Current	2.2 kV RMS, 50Hz, 1min
Input Vs AUX	3.3 kV RMS, 50Hz, 1min
Rs485 Vs Relay	2.2 kV RMS, 50Hz, 1min

Environmental

Operating temperature	-10 to +60°C
Storage temperature	-25 to +70°C
Relative humidity	0... 95% RH (non condensing)
Warm up time	Minimum 3 minute
Shock (As per IEC60068-2-27)	Half sine wave, Peak acceleration 30gn (300 m/s ²), duration 18ms.
Vibration	10 ... 150 ...10 Hz, 0.15mm amplitude
Number of Sweep cycles	10 per axis
Enclosure	IP20 (Terminal side) and IP50 (Front side)

Interfaces

Relay	250 VAC, 5A AC 30VDC, 5A DC
MODBUS	Rs485, Baud rate : 4.8k, 9.6k, 19.2k, 38.4k 57.6k bps (Response time > 200ms)

Installation:

Mechanical Housing	Lexan 940 (polycarbonate), Flammability Class V-0 acc. to UL 94, self extinguishing, non dripping, free of halogen
Mounting Position	Panel Mounted (96X96)
Connection Element	Conventional screw type terminal with indirect wire terminals (Screw Torque: 0.5N.m)
Connection Terminal	4mm ² solid or 2.5mm ² stranded cable
Weight	250 Gram Approx.

Datasheet subject to change without notice



Measure



Control



Record



Analyze

Measured Parameter System wise:

√ : Available

x : Not Available

Sr. No.	Parameter	3 Phase 4 Wire	3 Phase 3 Wire	1 Phase	1 Phase 3 Wire
1	System Volts	√	√	√	√
2	System Current	√	√	√	√
3	Voltage L1	√	x	x	√
4	Voltage L2	√	x	x	√
5	Voltage L3	√	x	x	x
6	Voltage L12	√	√	x	√
7	Voltage L23	√	√	x	x
8	Voltage L31	√	√	x	x
9	Current L1	√	√	x	√
10	Current L2	√	√	x	√
11	Current L3	√	√	x	x
12	Frequency	√	√	√	√
13	System Active Power	√	√	√	√
14	Active Power L1	√	x	x	√
15	Active Power L2	√	x	x	√
16	Active Power L3	√	x	x	x
17	System Re-active Power	√	√	√	√
18	Re-active Power L1	√	x	x	√
19	Re-active Power L2	√	x	x	√
20	Re-active Power L3	√	x	x	x
21	System Apparent Power	√	√	√	√
22	Apparent Power L1	√	x	x	√
23	Apparent Power L2	√	x	x	√
24	Apparent Power L3	√	x	x	x
25	System Phase Angle	√	√	√	√
26	System Power Factor	√	√	√	√
27	Power Factor L1	√	x	x	√
28	Power Factor L2	√	x	x	√
29	Power Factor L3	√	x	x	x
30	Phase Angle L1	√	x	x	√
31	Phase Angle L2	√	x	x	√
32	Phase Angle L3	√	x	x	x
33	RPM	√	√	√	√
34	Min and Max System Voltage	√	√	√	√
35	Min and Max System Current	√	√	√	√
36	Run Hour	√	√	√	√

Datasheet subject to change without notice



Measure



Control



Record



Analyze

Measured Parameter System wise:

√ : Available x : Not Available

Sr. No.	Parameter	3 Phase 4 Wire	3 Phase 3 Wire	1 Phase	1phase 3 Wire
37	On Hour	√	√	√	√
38	Number of Interruptions	√	√	√	√
39	Current Demand	√	√	√	√
40	kVA Demand	√	√	√	√
41	Import kW Demand	√	√	√	√
42	Export kW Demand	√	√	√	√
43	Max Current Demand	√	√	√	√
44	Max kVA Demand	√	√	√	√
45	Max Import kW Demand	√	√	√	√
46	Max Export kW Demand	√	√	√	√
47	Neutral Current	√	x	x	x
48	Inductive kVar Demand	√	√	√	√
49	Capacitive kVar Demand	√	√	√	√
50	Max Inductive kVar Demand	√	√	√	√
51	Max Capacitive kVar Demand	√	√	√	√

Ordering Information

Product Code: **DE20- 3 - 3 - 01 - 02 - X - H- 50000**

RISH DELTA POWER

Z – None
 S – 1 Relay Output
 M – RS485
 R – RS485 + 1 Relay Output

L: 20-60 V AC/DC
 H: 60-300 V AC/DC

Order Code Example: DE20-330102RH50000
 RISH Delta Power with Higher Auxiliary Supply, RS485 and 1 Relay Output

Datasheet subject to change without notice



Measure



Control



Record



Analyze



RISHABH

Datasheet subject to change without notice



Measure



Control



Record



Analyze

www.rishabh.co.in

RISHABH INSTRUMENTS LTD.

Domestic (India): +91 253 2202028/99 | marketing@rishabh.co.in

International: +91 253 2202004/06/08/99 | global@rishabh.co.in

www.rishabh.co.in