

# OPERATING MANUAL

## *Rish Eine NX 3 Phase*



# Rish Eine NX

## **PROGRAMMABLE DPM**

AC Volt Meter (3Φ) : DPM - 3V

AC Ammeter (3Φ) : DPM - 3A

### **Installation & Operating Instructions**

#### **Section**

#### **Contents**

1. Introduction
2. Measurement Reading Screens
3. Programming
  - 3.1 Set Up Screens
4. Relay Output
  - 4.1 Limit Switch
  - 4.2 Timer Output
5. Modbus Communication
  - 5.1 Accessing of 3x Registers
  - 5.2 Accessing of 4x Registers
6. Installation
  - 6.1 EMC Installation Requirements
  - 6.2 Case Dimensions and Panel Cut-out
  - 6.3 Wiring
  - 6.4 Auxiliary Supply
  - 6.5 Fusing
  - 6.6 Earth / Ground Connections
7. Connection Diagrams
  - 7.1 Connection Diagrams for DPM 3V
  - 7.2 Connection Diagrams for DPM 3A
8. Specifications

## 1. Introduction

The DPM Series is a panel mounted 96 x 96mm Digital Panel Meters for the measurement of AC Voltage and current in three phase or single phase systems. The instrument integrates accurate measurement technology. The parameters are displayed with Ultra high brightness LED display with 14mm Digit height which enables to take readings from long distance. Programmable DPM can be configured and Programmed at site for the following :

PT Primary, CT Primary, PT Secondary, CT Secondary. The front panel has two touch keys for user interface to scroll through the available parameters. The two keys has function as follow:



1.  : Scrolls through parameter in upward sequence.

Display sequence DPM 3V : L1 voltage, L2 voltage, L3 voltage, L1-L2 voltage, L2-L3 voltage, L3-L1 Voltage, Average Voltage, Relay 1 (only in advanced DPM) and back to L1 voltage.

Display sequence DPM 3A : L1 current, L2 current, L3 current, Average Current, Relay 1 (only in advanced DPM) and back to L1 current.

2.  : Scrolls the parameters in Reverse of above sequence.

## 2 . Measurement Reading Screen

In normal operation the user is presented with the measurement reading screens. These screens may be scrolled through one at a time in incremental order by touching the  key and in decrementing order by touching  key.



L1-N Voltage



L2-N Voltage



L3-N Voltage



Relay Status



L1-L2 Voltage



L2-L3 Voltage



L3-L1 Voltage



Average Voltage



**TABLE 1: Parameters Displayed with DPM 3V model**

Measured Parameters	Unit of measurement
L1 Voltage	Volt
L2 Voltage	Volt
L3 Voltage	Volt
L1-L2 Voltage	Volt
L2-L3 Voltage	Volt
L3-L1 Voltage	Volt
Average Voltage	Volt
Timer Relay	On/Off cycles
Limit Relay	On/Off



**TABLE 2: Parameters Displayed with DPM 3A model**

Measured Parameters	Unit of measurement
L1 Current	Ampere
L2 Current	Ampere
L3 Current	Ampere
Average Current	Ampere
Limit Relay	On/Off
Timer Relay	On/Off cycles

**Note: Relay output & MODBUS(RS485) option is only available in Advance DPM Model..**



L1 Current



L2 Current



L3 Current



Average Current

### Limit Relay Mode Status :



— Parameter name flash  
after 2 sec parameter status /value flash



— Parameter status /value flash

Relay 1 configured  
as limit relay and on

Relay 1 configured  
as limit relay and off

### Timer Relay Mode Status :



#### To access timer relay

Pressing the "↓" key 1 sec for enter edit mode for relay After Enter Edit mode

Pressing the "↑" key will scroll below options are "

The below options are possible:

1. oFF - Off Timer relay
2. on - On timer relay



#### timer relay Screen Confirmation

Pressing the "↓" key then exit relay access mode.



## Setup Parameter Screens :

Press UP and DOWN key simultaneously to enter into setup menu.

The meter shows only relevant setup screens according to meter model and configuration of relay.

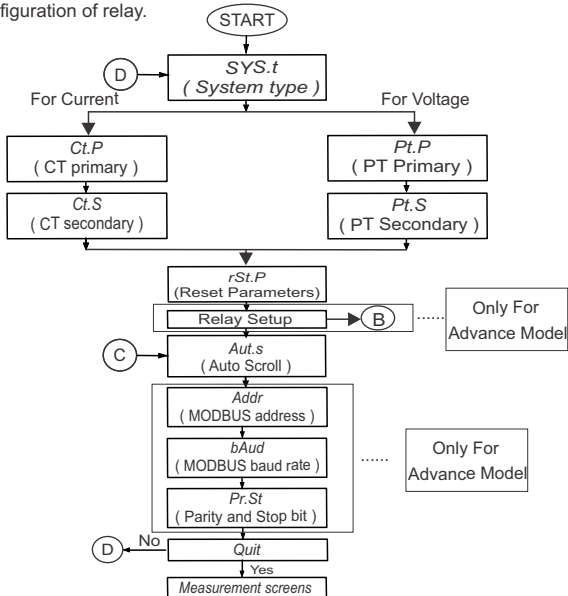

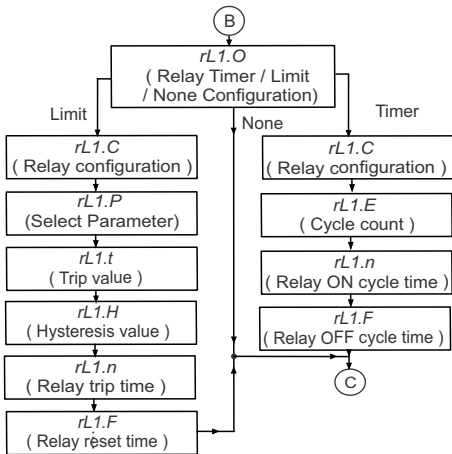

### 3. Programming

The following sections comprise step by step procedures for configuring the DPM for individual user requirements. To access the set-up screens touch and hold the “ $\uparrow$ ” and “ $\downarrow$ ” keys simultaneously. This will take the user into the Sys Type Screen Followed by “Sys” on Display(Section 3.1) .

#### 3.1 Set Up Screens

##### 3.1.1. System type

This screen is used to set the system type. System type can be set as 3Phase 4Wire, 3Phase 3Wire or 1Phase 2Wire.

Pressing the “ $\downarrow$  down” key accepts the present value and advances to the “PT primary (in case of 3V) or CT primary (in case of 3A) value Edit” menu (see section 3.1.2 for PT primary and 3.1.3. for CT primary). Pressing the “ $\uparrow$  up” key will enter to the system type selection menu and scroll the values through values available. Pressing the “ $\downarrow$  down” key advances to the system type confirmation menu.



##### System Type Confirmation

This screen will only appear following the edit of system type. If system type is to be edit again, Pressing the “ $\uparrow$  up” key will scroll between 3Phase 4Wire, 3Phase 3Wire or 1Phase 2Wire. Pressing the “ $\downarrow$ down” key sets the displayed value and will advance to “Potential Transformer Primary Value Edit” menu. (See section 3.1.2 for 3V and “Current transformer primary value (see section 3.1.3 for 3A)



##### 3.1.2. Potential Transformer Primary Value for 3V

This screen displays “Pt.P” message followed by previously set PT primary value on display. For DPM 3V user can set PT primary value from **100V<sub>LL</sub>** to **999kV<sub>LL</sub>**

Pressing the “ $\downarrow$ ” key accepts the present value and advances to the “PT Secondary” selection menu(See Section 3.1.4) for DPM -3V.

Pressing the “ $\uparrow$ ” key will enter the “Potential transformer Primary Value Multiplier Selection”.

Initially the “multiplier must be selected. Pressing the “ $\uparrow$ ” Key will move the decimal point position to the right side and show ####, after which it will again Shift to ####, #### with Annunciation of “x1000”, which indicates the value in kV. Pressing the “ $\downarrow$ ” key accepts the present multiplier (Decimal Point position) and advances to the “PT Primary value Edit” menu with decimal flashing to indicate cursor position.





### PT Primary value Edit

Pressing the "↑" key will scroll the value of the most significant digit. Pressing the "↓" key accepts the present value at the cursor position and advances the cursor to the next Less significant digit. When the least significant digit has been set,



pressing the "↓" key will advance to the "Potential transformer Primary Value Confirmation" screen. For **DPM 3 V**: When PT primary is set < 100VLL then meter shows "Err" & again goes to PT primary edit stage with the minimum PT primary value i.e. 100VLL

**Note** : the flashing decimal point indicates the cursor position, a steady decimal point will be present to identify the scaling of the number until the cursor position coincides with the steady decimal point position. At this stage the decimal point will be flashing.

### Potential Transformer Primary Value Confirmation

This screen will only appear following an edit of the Potential Transformer Primary Value. If the set value is to be corrected, pressing the "↑" key will return to the "Potential Transformer Primary Value Edit" stage. Pressing the "↓" key sets the value and then advance to the "PT secondary screen" Selection menu.



### 3.1.3 Current Transformer Primary Value (For 3A)

This screen displays "Ct.P" message followed by previously set CT primary value on display. This screen enables user to set CT primary from **1A to 9999A**.



Pressing the "↓" key accepts the present value and advances to the "CT Secondary Selection screen". Pressing the "↑" key will shift decimal point position to right side and show ###.#,###.#,####, after which it will again shift to ###.#,###.#,#### with Annunciation of "x1000", It indicates the value in kA. Pressing the "↓" key accepts the decimal point position and enters into Current Transformer Primary value edit.

### Current Transformer Primary value Edit

Pressing the "↑" key will scroll the value of the most significant digit. Pressing the "↓" key accepts the present value at the cursor position and advances the cursor to the next Less significant digit. When the least significant digit has been set, pressing the "↓" key will advance to the "Current transformer Primary Value confirmation" screen. When CT primary is set less than 1A, then meter shows "Err" and CT primary is set to 1A.

**Note** : the flashing decimal point indicates the cursor position, a steady decimal point will be present to identify the scaling of the number until the cursor position coincides with the steady decimal point position. At this stage the decimal point will be flashing.



A black rectangular box with the white text "SEL" inside.

### Current Transformer Primary Value Confirmation

This screen will only appear following an edit of the Current Transformer Primary Value. If the set value is to be corrected, pressing the "↑" key will return to the "Current Transformer Primary Value Edit" stage. Pressing the "↓" key sets the value and then advance to the "CT secondary" Selection menu.

#### 3.1.4. Potential Transformer Secondary Value (For 3V)

This screen displays "Pt.S" message followed by previously set PT secondary value on display. user can set PT secondary value from 100V<sub>LL</sub> to 500V<sub>LL</sub>.

A black rectangular box with the white text "Pt.S" inside.

Pressing the "↓" key accepts the present value and advances

to the "Reset Parameter" selection menu(See Section 3.1.6)

Pressing the "↑" key will enter the "Potential transformer Secondary Value Most significant digit Selection.

Pressing the "↑" key will scroll the value of the most significant digit.

Pressing the "↓" key accepts the present value at the cursor position and advances the cursor to the next Less significant digit. When the least significant digit has been set, pressing the "↓" key will advance to the

"Potential transformer secondary value confirmation" screen. For DPM 3V minimum PT secondary can set is 100V(L-L). otherwise meter shows "Err" and PT secondary is set to 100V(L-L).

A black rectangular box with the white text "500.0" inside.

### Potential Transformer Secondary Value Confirmation

This screen will only appear following an edit of the Potential Transformer Secondary Value. If the set value is to be corrected, pressing the "↑" key will return to the "Potential Transformer Secondary Value Edit" stage. Pressing the "↓" key sets the value and then advance to the "Reset Parameter" Selection menu in case of DPM -3V.

A black rectangular box with the white text "SEL" inside.

#### 3.1.5 Current Transformer Secondary Value (For 3A)

This screen is used to set Current transformer secondary value. "1" for CT secondary 1A and "5" for CT secondary 5A. pressing "↓" down" key accepts the present value and advanced to the "Reset Parameter" option.

A black rectangular box with the white text "CT.S" inside.A black rectangular box with the white text "5" inside.

### Current transformer Secondary confirmation screen:

When "↓" down key is pressed , set message screen will appear, if again down key is pressed value is accepted. If CT secondary value is to be edit once again, pressing "↑" up key user can scroll between "5" for CT secondary 5A and "1" for CT secondary 1A.

A black rectangular box with the white text "SEL" inside.

Pressing "↵" key will accept displayed value and advance to Reset parameter selection menu.

### 3.1.6 Reset parameter



Pressing the "↵" key will accept the display value and advances to "Relay Output Select" selection menu (See Section 3.1.7) .

Pressing the "↑" key will scroll through below options :

1. None - Do not reset any parameter
2. Fact - Factory reset i.e. all programmable parameters set to their factory default values. Meter restart after this option is selected

#### Reset parameter Screen Confirmation

Pressing the "↵" key set the selected option and advances "Relay Output Select" selection menu (See Section 3.1.7).

Pressing the "↑" key re-enter Screen selection menu.

### 3.1.7 Relay output select (Only in Advance DPM)

Pressing the "↵" key will accept the display value and advances to Next selection menu.

Pressing the "↑" key will scroll through below options :



1. None (nonE) - Relay is not activated.
2. Limit (Limt) - Relay is assigned as limit relay, which can be used to control or for indication that configured electrical parameter is not in band as specified by limits.

3. Timer (timr) (optional): Relay is assigned for timer function. This function can be use to turn on/off some control circuit based on precise timing. Relay switches according to number of cycles set in counter register and cycle on and off time. Default value is None.

#### Relay output select Screen Confirmation

If None is Selected & Pressing the "↵" key set the None option and advance to "Auto Scroll" menu. For advanced model If Limit or timer is Selected & Pressing the "↵" key advance to limit relay or timer relay configuration respectively.

Pressing the "↑" key re-enter Screen selection menu.

### 3.1.8 Limit Relay : Relay configuration (Only in Advance DPM)

Pressing the "↓" key will accept the display value and advances to Next selection menu.

Pressing the "↑" key will scroll through below options :

1. High Energize (H-En)
2. Low Energize (L-En)
3. High De-energize (HdEn)
4. Low De-energize (LdEn)

Default value is High Energize..

#### Limit Relay : Relay Configuration Select Screen Confirmation

Pressing the "↑" key set the selected option and advance to next menu for advanced model.

Pressing the "↓" key re-enter Screen selection menu.

### 3.1.9 Limit Relay : Relay Parameter (Only in Advance DPM)

Pressing the "↓" key will accept the display value and advances to next menu for advanced model.

Pressing the "↑" key will scroll option as per table 3 "

#### Limit Relay : Relay Parameter Screen Confirmation

Pressing the "↑" key set the selected option and advance to next menu for advanced model.

Pressing the "↓" key re-enter Screen selection menu.

### 3.1.10 Limit Switch : Trip Point (Only in Advance DPM)

This screen is used to set trip point for relay operation and display "rLIt"

Default value is parameter 100%

Pressing the "↓" key will accept the display value and advances to Next selection menu.

Pressing the "↑" key will enter the "set trip point for relay operation Value Most significant digit Selection.

Pressing the "↑" key will scroll the value of the most significant digit.

Pressing the "↓" key accepts the present value at the cursor position and advances the cursor to the next Less significant digit.

When the least significant digit has been set, pressing the "↓" key will advance to the "Limit Switch : Trip Point" screen. If invalid value is set then meter shows "Err"

#### **Limit Switch : Trip Point Value Confirmation**

This screen will only appear following an edit of the Limit Switch  
Limit Switch : Trip Point Value.

If the set value is to be corrected, pressing the "↑" key will return to the "Limit Switch : Trip Point" stage.

Pressing the "↓" key sets the value and then advance to the Next menu.

#### **3.1.11 Limit Switch : Hysteresis point (Only in Advance DPM)**

This screen is used to set trip point for relay operation and display "rLI.H"  
Value range from 0.5 to 50%.

Default value is parameter 20%.

Pressing the "↓" key will accept the display value and advances to Next selection menu.

Pressing the "↑" key will enter the "Limit Switch : Hysteresis point Value Most significant digit Selection.

Pressing the "↑" key will scroll the value of the most significant digit.

Pressing the "↓" key accepts the present value at the cursor position and advances the cursor to the next Less significant digit.

#### **Limit Switch : Hysteresis point Confirmation**

This screen will only appear following an edit of the  
Limit Switch : Hysteresis point.

If the set value is to be corrected, pressing the "↑" key will return to the "Limit Switch : Hysteresis point" stage.

Pressing the "↓" key sets the value and then advance to the Next menu

#### **3.1.12 Limit Switch : On delay (Only in Advance DPM)**

This screen is used to set trip point for relay operation and display "rLI.n"  
Value range from 1 to 60.

Default value is parameter 10.

Pressing the "↓" key will accept the display value and advances to Next selection menu.

Pressing the "↑" key will enter the "Limit Switch : On delay" point Value Most significant digit Selection.

Pressing the "↑" key will scroll the value of the most significant digit.

Pressing the "↓" key accepts the present value at the cursor position and advances the cursor to the next Less significant digit.

A digital display showing the text "SEL" in a white, segmented font on a black background.

A digital display showing the text "rLI.H" in a white, segmented font on a black background.

A digital display showing the number "200" in a white, segmented font on a black background.

A digital display showing the text "SEL" in a white, segmented font on a black background.

A digital display showing the text "rLI.n" in a white, segmented font on a black background.

A digital display showing the number "10" in a white, segmented font on a black background.

A black rectangular screen with the white text "SEL" in a digital font.

### Limit Switch : On delay Confirmation

This screen will only appear following an edit of the Limit Switch : On delay  
If the set value is to be corrected, pressing the "↑" key will  
return to the "Limit Switch : On delay" stage.

Pressing the "↓" key sets the value and then advance to the  
Next menu

### 3.1.13 Limit Switch : Off delay (Only in Advance DPM)

This screen is used to set trip point for relay operation and display "rL1.f"  
Value range from 1 to 60.

Default value is parameter 10.

Pressing the "↓" key will accept the display value and advances  
to Next selection menu.

Pressing the "↑" key will enter the "Limit Switch : Off delay"  
point Value Most significant digit Selection.

Pressing the "↑" key will scroll the value of the most significant digit.

Pressing the "↓" key accepts the present value at the cursor  
position and advances the cursor to the next Less significant digit.

A black rectangular screen with the white text "rL1.f" in a digital font.A black rectangular screen with the white text "10" in a digital font.A black rectangular screen with the white text "SEL" in a digital font.

### Limit Switch :Off delay Confirmation

This screen will only appear following an edit of the Limit Switch :off delay  
If the set value is to be corrected, pressing the "↑" key will  
return to the "Limit Switch : Off delay" stage.

Pressing the "↓" key sets the value and then advance to the  
Next menu

### 3.1.14 Timer Relay: Relay configuration (Only in Advance DPM)

This screen is used to set timer relay configuration for relay operation and  
display "rL1.c"

Pressing the "↓" key will accept the display value and advances  
to Next selection menu.

Pressing the "↑" key will scroll through option as follows :

1. Energize (Enr)

2. De-energize (dEnr)

Default value is Energize

A black rectangular screen with the white text "rL1.c" in a digital font.A black rectangular screen with the white text "Enr" in a digital font.A black rectangular screen with the white text "SEL" in a digital font.

### Timer Relay: Relay configuration Screen confirmation

Pressing the "↑" key set the selected option and advance  
to next menu for advanced model.

Pressing the "↓" key re-enter Screen selection menu.

### 3.1.15 Timer relay : Relay timer cycles (Only in Advance DPM)

This screen is used to Relay timer cycles for relay operation and display "rL1.E"  
Value range from 1 to 999.

Default value is 10.

Pressing the "↓" key will accept the display value and advances to Next selection menu.

Pressing the "↑" key will enter the "Relay timer cycles" operation Value Most significant digit Selection.

Pressing the "↑" key will scroll the value of the most significant digit.

Pressing the "↓" key accepts the present value at the cursor position and advances the cursor to the next Less significant digit.

#### Timer Relay : Relay timer cycles Confirmation

This screen will only appear following an edit of the

Limit Switch : Relay timer cycles

If the set value is to be corrected, pressing the "↑" key will return to the "Timer relay : Relay timer cycles" stage.

Pressing the "↓" key sets the value and then advance to the Next menu

### 3.1.16 Timer relay : ON relay time (Only in Advance DPM)

The screen is used to set on cycle time of timer value in second  
"rLin" message displayed on "rLn" message displayed on screen.  
Value range from 1 to 60.

Default value is parameter 10.

Pressing the "↓" key will accept the display value and advances to Next selection menu.

Pressing the "↑" key will enter the "Timer relay: On delay" point Value Most significant digit Selection.

Pressing the "↑" key will scroll the value of the most significant digit.

Pressing the "↓" key accepts the present value at the cursor position and advances the cursor to the next Less significant digit.

#### Limit Switch : On delay Confirmation

This screen will only appear following an edit of the Limit Switch : On delay

If the set value is to be corrected, pressing the "↑" key will return to the "Timer relay: On delay" stage.

Pressing the "↓" key sets the value and then advance to the Next menu



### 3.1.17 Timer relay : OFF relay time (Only in Advance DPM)

The screen is used to set on cycle time of timer value in second "rLIF" message displayed on screen  
Value range from 1 to 60.

Default value is parameter 10.

Pressing the "↓" key will accept the display value and advances to Next selection menu.

Pressing the "↑" key will enter the "Timer relay: OFF delay" point Value Most significant digit Selection.

Pressing the "↑" key will scroll the value of the most significant digit.

Pressing the "↓" key accepts the present value at the cursor position and advances the cursor to the next Less significant digit.

#### Timer Relay : Off delay Confirmation

This screen will only appear following an edit of the Timer relay : OFF delay  
If the set value is to be corrected, pressing the "↑" key will return to the "Timer relay: Off delay" stage.

Pressing the "↓" key sets the value and then advance to the Next menu



rLIF



10



SEL

### 3.1.18 Selection of Auto Scrolling or fixed Screen

Pressing the "↓" key will accept the display value and move to address mode.

Pressing the "↑" key will scroll between "Yes" and "No".

Select "Yes" for Auto scrolling of parameter display and Select "No" for fixed display screen.

Pressing the "↓" key will enter into Screen selection Confirmation screen.



Auto



no



### 3.1.19 RS485 MODBUS Device Address (Only in Advance DPM)

The screen is used to set device address for MODBUS communication appears with "Addr" message  
Value range from 1 to 247.



Addr



001



SEL

Default value is parameter 1.

Pressing the "↓" key will accept the display value and advances to Next selection menu.

Pressing the "↑" key will enter the "RS485 MODBUS device Addr" point Value Most significant digit Selection.

Pressing the "↑" key will scroll the value of the most significant digit.

Pressing the "↓" key accepts the present value at the cursor position and advances the cursor to the next Less significant digit.

#### Timer Relay : On delay Confirmation

This screen will only appear following an edit of the "RS485 MODBUS device Address"

If the set value is to be corrected, pressing the "↑" key will return to the "device address" stage.

Pressing the "↓" key sets the value and then advance to the Next menu.

### 3.1.20 RS485 MODBUS Communication Baud Rate (Only in Advance DPM)

This screen is used to set RS485 MODBUS Communication Baud Rate and display "baud"



baud



96



SEL

Pressing the "↓" key will accept the display value and advances to Next selection menu.

Pressing the "↑" key will scroll option are as follows: "

Option can be assigned as one of the following Baud rate parameter 4.8 kbps, 9.6 kbps, 19.2 kbps, 38.4 kbps, 57.6 kbps.

Default value is parameter : 9.6 kbps.

#### Rs485 MODBUS Communication Baud Rate Confirmation

Pressing the "↑" key set the selected option and advance to next menu for advanced model.

Pressing the "↓" key re-enter Screen selection menu.

### 3.1.21 RS485 MODBUS Communication Parity and Stop bit (Only in Advance DPM)

This screen is used to set parity and stop bit for MODBUS communication and display "Pr.St".



PrSt



no-1

Pressing the "↓" key will accept the display value and advances to Next selection menu.

Pressing the "↑" key will scroll option are as follows: "

Option can be assigned as one of the following Baud rate

no-1 : No parity and 1 stop bit

odd-1 : Odd parity and 1 stop bit

even-1 : Even parity and 1 stop bit

Default value is parameter: no-1s.

### Rs485 MODBUS Communication Parity and Stop bit Confirmation

Pressing the "↑" key set the selected option and advance to next menu menu for advanced model.

Pressing the "↓" key re-enter Screen selection menu.



SEL

#### 3.1.22 Exit from Setup Menu (Only in Advance DPM)

This screen is used to exit programming mode and display "Quit"

Pressing the "↓" key will accept the display value and advances

Exit programming mode display measurement screen.

Pressing the "↑" key will scroll option are as follows: "

**Yes** : Exit from setup to measurement

**No** : Continue in setup for editing

Default value is parameter: No..

Pressing the "↓" key re-enter Exit programming mode display measurement screen.



Quit



no

## 4. Relay Output

### 4.1 Limit Switch

Limit switch can be used to monitor the measured parameter ( Ref. TABLE 3 ) in relation to a set limit. The limit switch can be configured in one of the four mode given below:-

- 1) Hi-alarm & Energized Relay
- 2) Hi-alarm & De-Energized Relay
- 3) Lo-alarm & Energized Relay
- 4) Lo-alarm & De-Energized Relay

With User selectable Trip point, Hysteresis, On Delay & Off delay.

**Hi- Alarm:** If Hi-Alarm Energized or Hi-Alarm De-Energized option is selected then relay will get energized or De-energized, if selected parameter is greater than trip point.

**Lo-Alarm:** If Lo-Alarm Energized or Lo-Alarm De-Energized option is selected then relay will get energized or De-energized, if selected parameter is less than trip point.

**# Note:** For Lo-Alarm configuration, set the values of trip point & hysteresis such that % trip point + % hysteresis should be less than 120% Value.

**Trip Point:** Trip point can be set in the range as specified in TABLE 3 Hi-Alarm & 10% to 120 % of nominal value

**TABLE 3 : Parameters for Limit output**

Parameter Number	Parameter	3P 4W	3P 3W	1P 2W	Trip Point Set Range	100% Value
0	Voltage L1	✓	✗	✓	10 - 120 %	Vnom (L-N)
1	Voltage L2	✓	✗	✗	10 - 120 %	Vnom (L-N)
2	Voltage L3	✓	✗	✗	10 - 120 %	Vnom (L-N)
3	Current L1	✓	✓	✓	10 - 120 %	Inom
4	Current L2	✓	✓	✗	10 - 120 %	Inom
5	Current L3	✓	✓	✗	10 - 120 %	Inom
21	Average Voltage	✓	✓	✗	10 - 120 %	Nom
23	Average Current	✓	✓	✗	10 - 120 %	Nom
100	Voltage L12	✓	✓	✗	10 - 120 %	Vnom (L-L)
101	Voltage L23	✓	✓	✗	10 - 120 %	Vnom (L-L)
102	Voltage L31	✓	✓	✓	10 - 120 %	Vnom (L-L)

## Hysteresis

Hysteresis can be set in the range of 0.5% to 50 % of set trip point. If Hi-alarm Energized or Hi-alarm De-energized is selected then relay will get De-energized or Energized respectively, if set parameter value is less than Hysteresis. Similarly if Lo-alarm Energized or Lo-alarm De-energized is selected then relay will get De-energized or Energized respectively, if set parameter value is more than Hysteresis.

Note : In case of Lo-alarm if trip point is set greater than 80% then the **maximum hysteresis can be set such that the total Trip point + Hysteresis (% of trip point value)**

will not exceed 120% of range. For example :If trip point is set at 90%, then maximum 33.3% hysteresis should be set such that,  
 $[90 + 29.99 (33.3\% \text{ of } 90)] = 120$ .

### Note:

**Setting of Hysteresis and trip value is to be verified by user so that trip and reset value of relay parameter should lie within Minimum and Maximum range of that parameter.**

Energizing Delay: The energizing delay can be set in the range from 1 to 60 seconds.

De-Energizing Delay: The De-energizing delay can be set in the range from 1 to 60 seconds.

Examples of configuration:

Parameter No. 3 (Current 1)

Trip Point = 50%

Hysteresis = 50% of trip point

Energising Delay: 2 sec

De-energising Delay: 2 sec

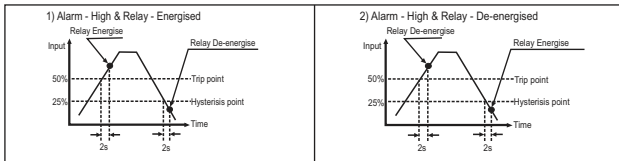

### 3) Alarm - Low & Relay - Energised

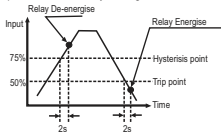

### 4) Alarm - Low & Relay - De-energised

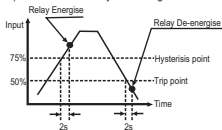

## 4.2 Timer Output

Timer output can be used to operate the Relay in a cyclic manner. The user can define the ON period and OFF period and also the number of times this cycle is to be repeated. The number of Cycles (N) can be indefinite or 1 to 9999. The counting is shown on a measurement screen as explained before.

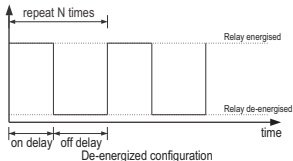
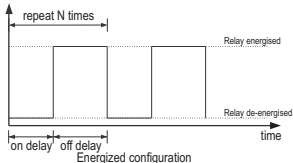

## 5. MODBUS Communication :

This instrument supports MODBUS (RS485) RTU protocol (2-wire) .

Connection should be made using twisted pair shielded cable. All "A or negative (-)" and "B or positive (+)" connections are daisy chained together. The screens should also be connected to the "Gnd" terminal. To avoid the possibility of loop currents, an Earth connection should be made at one point on the network. Loop (ring) topology does not require any termination load. Line topology may or may not require terminating loads depending on the type and length of cable used. The impedance of the termination load should match the impedance of the cable and be at both ends of the line. The cable should be terminated at each end with a 120 Ohm (1/4 Watt min.) resistor.

RS 485 network supports maximum length of 1.2km. Including the Master, a maximum of 32 instruments can be connected in RS485 network. The permissible address range for the instrument is between 1 and 247 for 32 instruments. Broadcast Mode (address 0) is not allowed. The maximum latency time for the instrument is 300ms i.e. this is the amount of time that can pass before the first response character is output.

After sending any query through software ( of the Master ) , it must allow 500ms of time to elapse before assuming that the DPM is not going to respond. If slave does not respond within 500 ms, Master can ignore the previous query and can issue fresh query to the slave.

The each byte in RTU mode has following format.

	8-bit binary, hexadecimal 0-9, A-F 2 hexadecimal characters contained in each 8-bit field of the message
<b>Format of Data Bytes</b>	4 bytes (32 bits) per parameter. Floating point format ( to IEEE 754) Most significant byte first.
<b>Error Checking Bytes</b>	2 byte Cyclic Redundancy Check (CRC)
<b>Byte format</b>	1 start bit, 8 data bits, least significant bit sent first 1 bit for even/odd parity 1 stop bit if parity is used; 1 or 2 bits if no parity

Communication Baud Rate is user selectable from the front panel between 4800, 9600, 19200, 38400, 57600 bps.

#### Function code

03	Read Holding Registers	Read content of read /write location ( 4X )
04	Read input Registers	Read content of read only location ( 3X )
10	Presets Multiple Registers	Set the content of read / write locations ( 4X )

**Exception Cases :** An exception code will be generated when DPM Meter receives Modbus query with valid parity & error check but which contains some other error ( e.g. Attempt to set floating point variable to an invalid value) The response generated will be "Function code" ORed with HEX (80H). The exception codes are listed below

01	Illegal function	The function code is not supported by DPM Meter
02	Illegal Data Address	Attempt to access an invalid address or an attempt to read or write part of a floating point value
03	Illegal Data Value	Attempt to set a floating point variable to an invalid value

#### 5.1 Accessing 3 X Register for Reading Measured Values

Two consecutive 16 bit registers represent one parameter. Refer table 6 for the addresses of 3X registers (Parameters measured by the instruments).

Each parameter is held in the 3X registers. Modbus Code 04 is used to access all parameters.

#### Example

To read parameter ,

Voltage L3 : Start address= 04 (Hex)      Number of registers = 02

#### Note : Number of registers = Number of parameters x 2

Each Query for reading the data must be restricted to 20 parameters or less. Exceeding the 20 parameter limit will cause a ModBus exception code to be returned.

## Query

01 (Hex)	04 (Hex)	00 (Hex)	04(Hex)	00 (Hex)	02(Hex)	30 (Hex)	0A (Hex)
Device Address	Function Code	Start Address High	Start Address Low	Number of Registers Hi	Number of Registers Lo	CRC Low	CRC High

Start Address High : Most significant 8 bits of starting address of the parameter requested.

Start Address low : Least significant 8 bits of starting address of the parameter requested.

Number of register Hi : Most significant 8 bits of Number of registers requested.

Number of register Lo : Least significant 8 bits of Number of registers requested.

**(Note : Two consecutive 16 bit register represent one parameter.)**

## Response: Volt3 (219.25V)

01 (Hex)	04 (Hex)	04 (Hex)	43(Hex)	5B (Hex)	41(Hex)	21 (Hex)	6F (Hex)	9B (Hex)
Device Address	Function Code	Byte Count	Data Register1 High Byte	Data Register1 Low Byte	Data Register2 High Byte	Data Register2 Low Byte	CRC Low	CRC High

Byte Count : Total number of data bytes received.

Data register 1 High Byte : Most significant 8 bits of Data register 1 of the parameter requested.

Data register 1 Low Byte : Least significant 8 bits of Data register 1 of the parameter requested.

Data register 2 High Byte : Most significant 8 bits of Data register 2 of the parameter requested.

Data register 2 Low Byte : Least significant 8 bits of Data register 2 of the parameter requested.

**(Note : Two consecutive 16 bit register represent one parameter.)**



**TABLE 6 : 3 X and 4 X register addresses for measured parameters**

Address (3X)	Address (4X)	Parameter Number	Parameter	Hex Address	
				High Byte	Low Byte
30001	40001	0	Voltage L1	00	00
30003	40003	1	Voltage L2	00	02
30005	40005	2	Voltage L3	00	04
30007	40007	3	Current I1	00	06
30009	40009	4	Current I2	00	08
30011	40011	5	Current I3	00	0A
30013	40013	6	---	00	0C
30015	40015	7	---	00	0E
30017	40017	8	---	00	10
30019	40019	9	---	00	12
30021	40021	10	---	00	14
30023	40023	11	---	00	16
30025	40025	12	---	00	18
30027	40027	13	---	00	1A
30029	40029	14	---	00	1C
30031	40031	15	---	00	1E
30033	40033	16	---	00	20
30035	40035	17	---	00	22
30037	40037	18	---	00	24
30039	40039	19	---	00	26
30041	40041	20	-----	00	28
30043	40043	21	Average Voltage	00	2A
30045	40045	22		00	2B
30047	40047	23	Average Current	00	2C
30051	40051	24		00	30
30071	40071	25	Frequency	00	46
30053	40053	26	-----	00	34
30055	40201	27	Voltage L12	00	C8
30057	40203	28	Voltage L23	00	CA
30071	40205	35	Voltage L31	00	CC

## 5.2 Accessing 4 X Register for Reading & Writing Parameter Values

Each parameter setting is held in the 4X registers. ModBus code 03 is used to read the current setting and code 10 is used to write/change the setting.

Refer **Table 7** for 4 X Register addresses.

### Example : Reading System type

System type : Start address= 177A (Hex)      Number of registers = 02

**Note : Number of registers = Number of Parameters x 2**

### Query

Device Address	01 (Hex)
Function Code	03 (Hex)
Start Address High	17 (Hex)
Start Address Low	7A (Hex)
Number of Registers Hi	00 (Hex)
Number of Registers Lo	02 (Hex)
CRC Low	E0 (Hex)
CRC High	66 (Hex)

**Start Address High** : Most significant 8 bits of starting address of the parameter requested.

**Start Address low** : Least significant 8 bits of starting address of the parameter requested.

**Number of register Hi** : Most significant 8 bits of Number of registers requested.

**Number of register Lo** : Least significant 8 bits of Number of registers requested.

**(Note : Two consecutive 16 bit register represent one parameter.)**

### Response: System Type ( 3phase 4 wire = 3 )

Device Address	01 (Hex)
Function Code	03 (Hex)
Byte Count	04 (Hex)
Data Register1 High Byte	40 (Hex)
Data Register1Low Byte	40 (Hex)
Data Register2 High Byte	00 (Hex)
Data Register2 Low Byte	00 (Hex)
CRC Low	EE (Hex)
CRC High	27 (Hex)

**Byte Count** : Total number of data bytes received.

**Data register 1 High Byte** : Most significant 8 bits of Data register 1 of the parameter requested.

**Data register 1 Low Byte** : Least significant 8 bits of Data register 1 of the parameter requested.

**Data register 2 High Byte** : Most significant 8 bits of Data register 2 of the parameter requested.

**Data register 2 Low Byte** : Least significant 8 bits of Data register 2 of the parameter requested.

**(Note : Two consecutive 16 bit register represent one parameter.)**

**Example : Writing System type**

System type : Start address= 177A (Hex) Number of registers = 02

**Query : ( Change System type to 3phase 3wire = 2 )**

Device Address	01 (Hex)
Function Code	10 (Hex)
Starting Address Hi	17 (Hex)
Starting Address Lo	7A(Hex)
Number of Registers Hi	00 (Hex)
Number of Registers Lo	02(Hex)
Byte Count	04 (Hex)
Data Register-1 High Byte	40 (Hex)
Data Register-1 Low Byte	00(Hex)
Data Register-2 High Byte	00(Hex)
Data Register-2 Low Byte	00(Hex)
CRC Low	8A (Hex)
CRC High	C4 (Hex)

Byte Count : Total number of data bytes sent.

Data register 1 High Byte : Most significant 8 bits of Data register 1 of the parameter being written.

Data register 1 Low Byte : Least significant 8 bits of Data register 1 of the parameter being written.

Data register 2 High Byte : Most significant 8 bits of Data register 2 of the parameter being written.

Data register 2 Low Byte : Least significant 8 bits of Data register 2 of the parameter being written.

**(Note : Two consecutive 16 bit register represent one parameter.)**

## Response

Device Address	01 (Hex)
Function Code	10 (Hex)
Start Address High	17 (Hex)
Start Address Low	7A(Hex)
Number of Registers Hi	00 (Hex)
Number of Registers Lo	02(Hex)
CRC Low	65 (Hex)
CRC High	A5 (Hex)

Start Address High : Most significant 8 bits of starting address of the parameter written.

Start Address low :Least significant 8 bits of starting address of the parameter written.

Number of register Hi : Most significant 8 bits of Number of registers written.

Number of register Lo : Least significant 8 bits of Number of registers written.

**(Note : Two consecutive 16 bit register represent one parameter.)**

**TABLE 7 : 4 X register addresses**

Address (Register)	Parameter No.	Parameter	Read/ Write	Modbus Start Addr.(H)		Default	
				High Byte	Low Byte	3P	1P
46003	1	---		17	72	--	--
46005	2	---		17	74	--	--
46007	3	---		17	76	--	--
46009	4	---		17	78	--	--
46011	5	System type	RWp	17	7A	3	1
46013	6	---		17	7C	--	--
46015	7	Reset parameters	RWp	17	7E	0	0
46017	8		RWp	17	80	10	10
46019	9	RS485 setup code	RWp	17	82	4	4
46021	10	Node address	RWp	17	84	1	1
46023	11	---	RWp	17	86	--	--
46025	12	---	RWp	17	88	--	--
46027	13	---	RWp	17	8A	--	--
46029	14	---	RWp	17	8C	--	--
46031	15	---	RWp	17	8E	--	--
46033	16		RWp	17	90		
46035	17	PT primary	RWp	17	92	500	500
46037	18	CT primary	RWp	17	94	5	5
46039	19	----	RWp	17	96	--	--
46041	20	----	RWp	17	98	--	--
46043	21	----	RWp	17	9A	--	--
46045	22	CT Secondary	RWp	17	9C	5	5
46047	23	PT Secondary	RWp	17	9E	500	500
46049	24	Relay output ( Limit / Timer )	RWp	17	A0	0	0
46051	25	Relay parameter select / Timer Relay counting cycles	RWp	17	A2	0/10	0/10
46053	26	Limit Relay trip point	RWp	17	A4	100	100
46055	27	Limit Relay hysteresis point	RWp	17	A6	20	20
46057	28	Limit Relay on delay / Timer Relay ON cycle time	RWp	17	A8	10	10
46059	29	Limit Relay off delay / Timer Relay OFF cycle time	RWp	17	AA	10	10

**TABLE 7 : continued...**

Address (Register)	Parameter No.	Parameter	Read/ Write	Modbus Start Addr. Hex		Default 3P/1P
				High Byte	Low Byte	
46061	30	Limit Relay configuration / Timer Relay configuration	R/Wp	17	AC	HEn/Enr
46063	31	---	R/Wp	17	AE	--
46065	32	---	R/Wp	17	B0	--
46067	33	---	R/Wp	17	B2	--
46069	34	---	R/Wp	17	B4	--
46071	35	---	R/Wp	17	B6	--
46073	36	--	R/Wp	17	B8	--
46075	37	--	R/Wp	17	BA	--
46077	38	---	R/Wp	17	BC	0000
46079	39	Autoscroll	R/Wp	17	BE	No
46081	40	---	R/Wp	17	C0	0
46083	41	---	R/Wp	17	C2	--
46085	42	---	R/Wp	17	C4	--
46087	43	---	R/Wp	17	C6	--
46089	44	Timer Relay Start / Stop	R/Wp	17	C8	0
46091	45	---	R/Wp	17	CA	--
46093	46	---	R/Wp	17	CC	--
46095	47	---	R/Wp	17	CE	--
46097	48	---	R/Wp	17	D0	--
46099	49	---	R/Wp	17	D2	--
46101	50	---	R/Wp	17	D4	--
46103	51	---	R/Wp	17	D6	--
46105	52	---	R/Wp	17	D8	--
46107	53	---	R/Wp	17	DA	--
46109	54	---	R/Wp	17	DC	--

### Explanation for 4 X register :

**NOTE:** Writing any invalid values (non-applicable values) to any of the following locations will result in modbus error.

Address	Parameter	Description
46003	----	----
46005	----	----
46007	----	----
46009	----	----
46011	System Type	This address is used to set the System type. Write one of the following value to this address. 1: 1 Phase 2 Wire 2: 3 Phase 3 Wire 3: 3 Phase 4 Wire.
46013	----	----
46015	Reset Parameters	This address is used to reset different parameters. Write specific value to this register to reset the corresponding parameter. Following are the values to reset various data. 7: None 8: Factory Reset
46017	----	----
46019	Rs485 Set-up Code	This address is used to set the baud rate, Parity and Number of stop bits. Refer <b>TABLE 9</b> for details.
46021	Node Address	Used to set Device address between 1 and 247 for MODBUS

Address	Parameter	Description
46023	----	----
46025	----	----
46027	----	----
46029	----	----
46031	----	----
46033	----	----
46035	PT Primary	This address allows the user to set PT Primary value. For 3-phase variant settable range is 100 VL-L to 999 kVL-L.
46037	CT Primary	This address allows the user to set CT Primary value. The settable range is 1A to 9999A.



Address	Parameter	Description
46039	----	----
46041	----	----
46043	----	----
46045	CT Secondary	This address is used to read and write the CT secondary value. The settable value is 1 for 1A or 5 for 5A.
46047	PT secondary	This address is used to read and write the PT secondary value. The settable range is 100-500VLL.
46049	Relay output select	This address is used to select the Relay operation as Timer/Limit. Write one of the following values to this address. <b>0:</b> None <b>2:</b> Limit <b>3:</b> Timer
46051	Relay Para select / No. of Cycles	This address is used to assign the Parameter to Relay. Limit relay: Refer <b>TABLE 3</b> The number of cycle can be 1 to 999.
46053	Limit Trip Point	This address is used to set the trip point for relay operations between 10% to 120%.
46055	Limit Hysteresis	This address is used to set the hysteresis between 0.5 to 50.0%.
46057	Relay On (Energize) Delay / On Time	This address is used to set the Energizing delay or On delay in seconds in range of 1 to 60.
46059	Relay Off (De-Energize) Delay / Off Time	This address is used to set the De-energizing delay or Off delay in seconds in range of 1 to 60

Address	Parameter	Description
46061	Limit / Timer Configuration Select	This address is used to set the Configuration for Relay 1 Refer <b>TABLE 8</b> .
46063	----	----
46065	----	----
46067	----	----
46069	----	----
46071	----	----
46073	----	----
46075	----	----
46077	----	----
46079	Autoscroll	This address allows the user to set auto-scrolling for display screen. 0 : No 1: Yes
46081	----	----
46083	----	----

Address	Parameter	Description
46085	----	----
46087	----	----
46089	Timer start stop	This address is used to start or stop timer cycles in timer mode. 0: Stop timer      1: Start timer
46091	----	----
46093	----	----

TABLE 8: Relay Configuration

For Limit Relay

Code	Configuration
0	Hi - alarm & energised Relay
1	Hi - alarm & De-energised Relay
2	Lo - alarm & Energised Relay
3	Lo - alarm & De-energised Relay

For Timer relay

Code	Configuration
0	Energize
1	De-energize

TABLE 9: RS485 Configuration

Decimal No.	Baud Rate	Parity	Stop Bit
0	4800	None	1
1	4800	None	2
2	4800	Even	1
3	4800	Odd	1
4	9600	None	1
5	9600	None	2
6	9600	Even	1
7	9600	Odd	1
8	19200	None	1
9	19200	None	2
10	19200	Even	1
11	19200	Odd	1
12	38400	None	1
13	38400	None	2
14	38400	Even	1
15	38400	Odd	1
16	57600	None	1
17	57600	None	2
18	57600	Even	1
19	57600	Odd	1

## 6. Installation

Mounting of DPM is featured with easy "Click fit" mounting. Push the meter in panel slot (size 92 x92 mm), it will click fit into panel with the four integral retention clips on two sides of meter.

If required Additional support is provided with swivel screws (optional) as shown in figure.

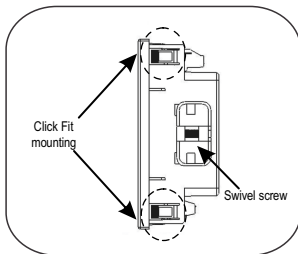

As the front of the enclosure conforms to IP 50, additional protection to the panel may be obtained by the use of an optional panel gasket. The terminals at the rear of the product should be protected from liquids. The DPM should be mounted in a reasonably stable ambient temperature and where the operating temperature is within the range 0 to 50 °C . Vibration should be kept to a minimum and the product should not be mounted where it will be subjected to excessive direct sunlight.

### Caution

1. In the interest of safety and functionality this product must be installed by a qualified engineer, abiding by any local regulations.
2. Voltages dangerous to human life are present at some of the terminal connections of this unit. Ensure that all supplies are de-energised before attempting any connection disconnection.
3. These products do not have internal fuses therefore external fuses must be used to ensure safety under fault conditions.

## 6.1 EMC Installation Requirements

This product has been designed to meet the certification of the EU directives when installed to a good code of practice for EMC in industrial environments, e.g.

1. Screened output and low signal input leads or have provision for fitting RF suppression components, such as ferrite absorbers, line filters etc., in the event that RF fields cause problems.

**Note:** It is good practice to install sensitive electronic instruments that are performing critical functions, in EMC enclosures that protect against electrical interference which could cause a disturbance in function.

2. Avoid routing leads alongside cables and products that are, or could be, a source of interference.
3. To protect the product against permanent damage, surge transients must be limited to 2kV pk. It is good EMC practice to suppress differential surges to 2kV at the source. The unit has been designed to automatically recover in the event of a high level of transients. In extreme circumstances it may be necessary to temporarily disconnect the auxiliary supply for a period of greater than 5 seconds to restore correct operation.
4. ESD precautions must be taken at all times when handling this product.

## 6.2 Case Dimensions and Panel Cut Out

### 6.2.1 for 96X96 models

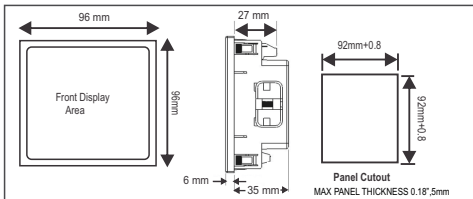

### 6.3 Wiring

Input connections are made directly to screw-type terminals with indirect wire pressure. Numbering is clearly marked on the connector. Choice of cable should meet local regulations. Terminal for inputs will accept up to 4mm<sup>2</sup> (12 AWG) solid or 2.5mm<sup>2</sup> stranded cable.

**Note :** 1) It is recommended to use wire with lug for connection with meter.

2) For disconnecting the device a switch or circuit-breaker shall be included at the site and shall be within easy reach of the operator. The specification are as below.

For aux. = At least 1.5 times of applied Power supply.

For Measuring Input = At least 1.5 times of applied measuring inputs.

### 6.4 Auxiliary Supply

DPM should ideally be powered from a dedicated supply, however it may be powered from the signal source, provided the source remains within the limits of the chosen auxiliary voltage.

### 6.5 Fusing

It is recommended that all voltage lines are fitted with 1 amp HRC fuse.

### 6.6 Earth/Ground Connections

For safety reasons, panels and accessories should be grounded in accordance

## 7. Connection Diagrams

### 7.1 Connections for DPM 3V

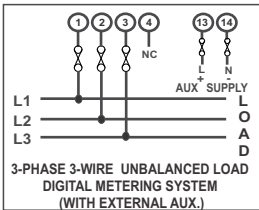
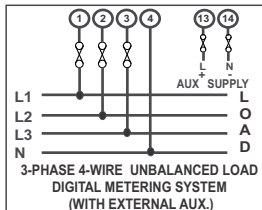

## 7.2 Connections for DPM 3A

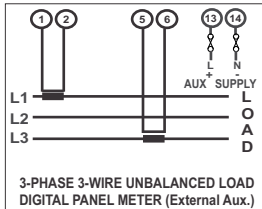
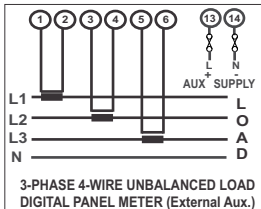



## 8. Specifications :

### Input voltage :

<b>Nominal Input Voltage Ranges</b>	100 VLL - 500VLL
Max continuous input voltage	120% of nominal voltage of primary (OL>1.21 x PTP)
Nominal input voltage burden	0.3 VA approx per phase at 230VAC
System PT Primary values	100VL-L to 999kV L-L Programmable onsite

### Input current :

Nominal Input Current Ranges	(1A or 5A per phase).
System CT Primary values	1A to 9999A Programmable onsite
Max continuous input current	120% of nominal current of primary (OL>1.21 x CTP)
Nominal input current burden	0.3VA approx. per phase

### Overload Indication :

"-oL-"  
(If input is greater than 121% of primary value )

### Auxiliary Supply :

AC-DC Auxiliary Supply 60V to 300V AC/DC (+/- 5%)

Frequency Range for AC Aux. Supply 45 to 65 Hz  
VA Burden 5 VA Approx

### Overload Withstand :

Voltage 620 VLL for 1 Second, repeated  
10 times at 10 second interval.  
Current 2 X 5A Value for 1 Second, repeated  
5 times at 5 second interval.

### Operating Measuring Ranges

Voltage Range 11 ... 346VLN(19...600VLL)  
Current Range For 1A(35mA-1.2A) & For 5A(55mA-6A)  
Frequency 40 ... 70 Hz

## Reference conditions for Accuracy :

Reference temperature	23 °C ± 2 °C
Input waveform	Sinusoidal (distortion factor 0.005)
Auxiliary supply voltage	Nominal Value ± 1 %
Auxiliary supply frequency	Nominal Value ± 1 %
Input Frequency	50 Hz or 60 Hz

## Accuracy

Voltage	± 0.5% of Nominal value .
Current	± 0.5% of 1A/5A.

## Temperature Coefficient

Voltage	0.025% / °C
Current	0.05% / °C

## Display

LED	1 line 4 digits
Digit height	14mm
Annunciator LEDs	For Displaying Units and Parameter

## Controls

User Interface	2 Touch Keys
----------------	--------------

## Interfaces: (Optional for only in Advance DPM )

Relay	250 VAC, 5 AAC / 30VDC, 5A DC
Modbus	Rs485, max.1200m Baud rate : 4.8, 9.6,19.2, 38.4, 57.6 KBPS

## Applicable Standards

EMC	IEC 61326-1 ( Table 2 )
Safety	IEC 61010-1: 2010,Permantly Connected use
IP for water & dust	IEC 60529

## Additional Errors:

Variation due to radiated susceptibility : (Only for current DPM ) ± 9 % of In

## Safety

Pollution Degree	2
Installation Category	III
High Voltage Test	2 kV AC, 50 Hz for 1 minute between aux and measuring input

## Environmental conditions

Operating temperature	0 to 55 °C
Storage temperature	0 to 70 °C
Relative humidity	0 .. 90 % (Non condensing)
Warm up time	Minimum 3 minute
Shock	Half sign wave, peak acceleration 30gn (300 m/s <sup>2</sup> )
Vibration	10 .. 55 Hz, 0.15mm amplitude

## Enclosure

Front	IP50
Back	IP20
Material	Polycarbonate Housing
Terminals	Screw-type terminals

## Dimension and weight:

Bezel Size (DIN 43718)	96mm X 96mm (DIN 43718 )
Panel Cut-Out	92 + 0.8mm X 92 + 0.8mm
Overall Depth	40mm
Weight	200g Approx.

---

The Information contained in these installation instructions is for use only by installers trained to make electrical power installations and is intended to describe the correct method of installation for this product. However, Manufacturer has no control over the field condition which influence product installation.

It is the user's responsibility to determine the suitability of the installation method in the user's field conditions. Manufacturer only obligations are those in Manufacturer standard Conditions of Sale for this product and in no case will Manufacturer be liable for any other Incidental, indirect or consequential damages arising from the use or misuse of the products.

---