

Operating Manual

RISH EM 2340



DIGITAL MULTIFUNCTION INSTRUMENT

Programmable Multi-function Energy Meter

Installation & Operating Instructions

Section	Contents
1.	Introduction
2.	Measurement Reading Screens
3.	Programming
3.1	Password Protection
3.2	Menu selection
3.2.1	System Parameter selection screen
3.2.1.1	System Type
3.2.1.2	Potential Transformer Primary value
3.2.1.3	Potential Transformer Secondary value
3.2.1.4	Current Transformer Primary value
3.2.1.5	Current Transformer Secondary value
3.2.1.6	Demand Integration Time
3.2.1.7	Auto Scrolling
3.2.1.8	Low Current Noise Cutoff
3.2.1.9	No. of Poles Selection
3.2.1.10	Energy Output
3.2.1.11	Energy Digit Reset count
3.2.1.12	Energy Rate
3.2.2	Communication Parameter selection screen
3.2.2.1	Address Setting
3.2.2.2	RS 485 Baud rate
3.2.2.3	RS 485 Parity selection
3.2.3	Reset Parameter selection screen
3.2.3.1	Resetting Parameter
3.2.4	Output Option selection screen (menu)
3.2.4.1	Configuration of Output
3.2.4.1.1	Relay 1 & 2 Output Selection menu
3.2.4.1.1.1	Pulse Output
3.2.4.1.1.1.1	Assignment of Energy to Pulse
3.2.4.1.1.1.2	Pulse Duration Selection

- 3.2.4.1.1.3 Pulse Rate
 - 3.2.4.1.1.2 Limit output
 - 3.2.4.1.1.2.1 Assignment of Limit Output to Parameter
 - 3.2.4.1.1.2.2 Limit Configuration
 - 3.2.4.1.1.2.3 Trip point selection
 - 3.2.4.1.1.2.4 Hysteresis selection
 - 3.2.4.1.1.2.5 Energizing delay time
 - 3.2.4.1.1.2.6 De-energizing delay time
 - 3.2.5 User Assignable Features
 - 3.2.5.1 Feature Selection Menu
 - 3.2.5.1.1 Backlit
 - 3.2.5.1.2 User Assignable Screens
 - 3.2.6 Quit screen
 - 4. Current Reversal screen
 - 5. Phase Rotation Error screen
 - 6. Phase Absent screen
 - 7. Run - Hour
 - 8. On - Hour
 - 9. Number of Interruption
 - 10. Relay Output
 - 10.1 Pulse output
 - 10.2 Limit Switch
 - 11. Phasor Diagram
 - 12. Installation
 - 12.1 EMC Installation Requirements
 - 12.2 Case Dimensions and Panel Cut-out
 - 12.3 Wiring
 - 12.4 Auxiliary Supply
 - 12.5 Fusing
 - 12.6 Earth / Ground Connections
 - 13. Connection Diagrams
 - 14. Optional Pluggable Module
 - 15. Specification
 - 16. Connection for Optional Pulse output / RS 485

1. INTRODUCTION

The Multifunction Energy Meter is a panel mounted 96 x 96mm DIN Quadratic Digital Panel Meter, which measures important electrical parameters in 3 ph 4 wire / 3 wire / 1ph Network and replaces the multiple analog panel meters. It measures electrical parameters like AC voltage, Current, Frequency, Power, Energy(Active / Reactive / Apparent), phase angle, power factor & many more. The instrument integrates accurate measurement technology (All Voltages & current measurements are True RMS upto 15th Harmonic) with LCD display with backlight.



It can be configured & Programmed at site for the following :
PT Primary, PT Secondary, CT Primary, CT Secondary 3 Phase 3W,
3 Phase 4W, 1 Phase 2W system.

The front panel has two push buttons using which the user can scroll through different screens, reset the energy & configure the product. The front panel also has Impulse red led, flashing at rate proportional to measured power.

DOWN **UP**

2. MEASUREMENT READING SCREENS

In normal operation, the user is presented with one of the measurement reading screens out of several screens. These screens may be scrolled through one at a time in incremental order by pressing the "UP key" and in decremental order by pressing "DOWN key".

TABLE 1 : Measurement Screens

Screen No.	Parameters	3PH 4W	3PH 3 W	1PH 2W
1	Sys Power / Voltage / Current	√	√	√
2	L-N Voltage	√	x	x
3	L-L Voltage	√	√	x
4	Current	√	√	x
5	RPM / Frequency	√	√	√
6	Sys W / VA / Phase Angle	√	√	√
7	Sys VAr / PF	√	√	√
8	Active Energy Utility*	√	√	√
9	Active Energy GEN*	√	√	√
10	Reactive Energy Utility*	√	√	√
11	Reactive Energy GEN*	√	√	√
12	Apparent Energy Utility*	√	√	√
13	Apparent Energy GEN*	√	√	√
14	Min Sys Voltage & Current	√	√	√
15	Max Sys Voltage & Current	√	√	√
16	R Phase W / VA / Phase Angle	√	x	x
17	Y Phase W / VA / Phase Angle	√	x	x
18	B Phase W / VA / Phase Angle	√	x	x
19	R Phase VAr / PF	√	x	x
20	Y Phase VAr / PF	√	x	x
21	B Phase VAr / PF	√	x	x
22	W / VA / Current Demand (Utility/GEN)	√	√	√
23	Max W / VA / Current Demand (Utility)*	√	√	√
25	Max W / VA / Current Demand (GEN)*	√	√	√
26	Per Phase Voltage THD	√	√	x
27	Per Phase Current THD	√	√	x
28	Sys Voltage / Current THD	√	√	√
29	Run Hour Utility	√	√	√
30	On Hour Utility	√	√	√

TABLE 1 : Continued...

Screen No.	Parameters	3PH 4W	3PH 3 W	1PH 2W
31	Run Hour GEN	√	√	√
32	On Hour GEN	√	√	√
33	Total Run Hour	√	√	√
34	Total On Hour	√	√	√
35	No of Interruptions Utility	√	√	√
36	No of Interruptions GEN	√	√	√
37	I Neutral	√	x	x
38	Old Active Energy Utility*	√	√	√
39	Old Active Energy GEN*	√	√	√
41	Old Reactive Energy Utility*	√	√	√
42	Old Reactive Energy GEN*	√	√	√
43	Old Apparent Energy Utility*	√	√	√
44	Old Apparent Energy GEN*	√	√	√
45	Old Run Hour Utility	√	√	√
46	Old On Hour Utility	√	√	√
47	Old Run Hour GEN	√	√	√
48	Old On Hour GEN	√	√	√
49	Old Total Run Hour	√	√	√
50	Old Total On Hour	√	√	√
51	Old No of Interruptions Utility	√	√	√
52	Old No of Interruptions GEN	√	√	√
53	Current Reversal	√	√	√
54	Phase Rotation Error	√	√	x
55	Phase Absent	√	√	x

NOTE:

* indicates that when Generator is ON, all marked Utility Screens will toggle between reading and "Utility" message and when Generator is OFF, all marked Generator screens will toggle between reading and "Generator" message.

EM 2340 Setup Parameter Screen

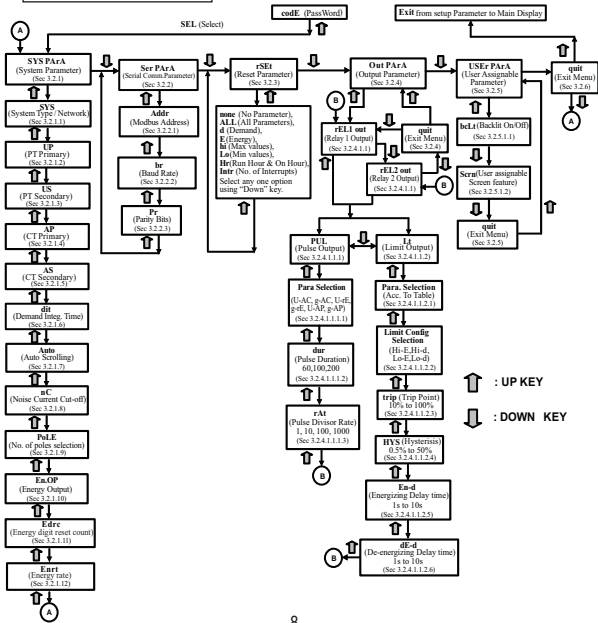

3. PROGRAMMING

The following sections comprise step by step procedures for configuring the Multifunction Meter according to individual user requirements.

To access the set-up screens press and hold "↑UP" and "↓DOWN" keys simultaneously for 5 seconds. This will take the User into the Password Protection Entry Stage (Section 3.1).

3.1. Password Protection

Password protection can be enabled to prevent unauthorised access to set-up screens, by default password protection is not enabled.

Password protection is enabled by selecting a four digit number other than 0000, setting a password of 0000 disables the password protection.

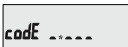

codE - - - -

Enter Password, prompt for first digit. (*Denotes that decimal Point will be flashing).

Press the "↓" key to scroll the value of first digit from 0 through to 9, the value will wrap from 9 round to 0.

Press the "↑" key to advance to next digit. In special case where the Password is "0000" pressing the "↑" key when prompted for the first digit will advance to "Password confirmed" screen.

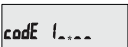

codE 1 - - -

Enter Password, first digit entered, prompt for second digit. (*Denotes that decimal Point will be flashing).

Use the "↓" key to scroll the value of the second Digit from 0 through to 9, the value will wrap from 9 round to 0.

Press the "↑" key to advance to next digit.

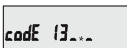

codE 13 - -

Enter Password, second digit entered, prompt for third digit. (* Denotes that decimal point will be flashing).

Use the "↓" key to scroll the value of the third digit from 0 through to 9, the value will wrap from 9 round to 0.

Press the "↑" key to advance to next digit.

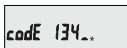

codE 134 -

Enter Password, third digit entered, prompt for fourth digit. (*Denotes that decimal point will be flashing).

Use the "↓" key to scroll the value of the fourth digit from 0 through to 9, the value will wrap from 9 round to 0.

Press the "↑" key to advance to verification of the password.

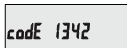

codE 1342

Enter Password, fourth digit entered, awaiting verification of the password.

Password confirmed.

codE 1342 done

Pressing the \downarrow key will advance to the "New / change Password" entry stage.

Pressing the \uparrow key will advance to the Menu selection screen. (See section 3.2).

Password Incorrect.

codE ---- Err

The unit has not accepted the Password entered.

Pressing the \downarrow key will return to the Enter Password stage.

Pressing the \uparrow key exits the Password menu & returns operation to the measurement reading mode.

New / Change Password

codE 2.000 Ed t

(* Decimal point indicates that this will be flashing).

Pressing the \downarrow key will scroll the value of the first digit from 0 through to 9, the value will wrap from 9 round to 0.

Pressing the \uparrow key to advance the operation to the next digit and sets the first digit, in this case to "2"

codE 2 1.00 Ed t

New/ Change Password, first digit entered, prompting for second digit. (*Decimal point indicates that this will be flashing).

Pressing the \downarrow key will scroll the value of the second digit from 0 through to 9, the value will wrap from 9 round to 0.

Pressing the \uparrow key to advance the operation to the next digit and sets the second digit, in this case to "1"

codE 2 15.0 Ed t

New / Change Password, second digit entered, prompting for third digit. (*decimal point indicates that this will be flashing).

Pressing the \downarrow key will scroll the value of the third digit from 0 through to 9, the value will wrap from 9 round to 0.

Pressing the \uparrow key to advance the operation to the next digit and sets the third digit, in this case to "5"

codE 2 153. Ed t

New/ Change Password, third digit entered, prompting for fourth digit. (* denotes that decimal point will be flashing).

Pressing the \downarrow key will scroll the value of the fourth digit from 0 through to 9, the value will wrap from 9 round to 0.

Pressing the \uparrow key to advance the operation to the "New Password Confirmed" & sets the fourth digit in this case to "3".

New Password confirmed.

codE 2 153 SEt

Pressing the \downarrow key will return to the "New/Change Password".

Pressing the \uparrow key will advances to the Menu selection screen. (see section 3.2).

3.2 Menu selection.

3.2.1 System Parameter selection screen

SEL SYS PAR

This screen is used to select the different system Parameter like "system type",

"CT Ratio", "PT Ratio", Pressing the **↑** key allows the user to set Different system parameters.
(see section 3.2.1.1 to 3.2.1.12)

Pressing the **↓** key will advance to Communication selection screen (see section 3.2.2)

3.2.2 Communication Parameter selection screen

SEL **SEr** **PARrA**

This screen is used to select the different communication parameters like "Address selection", "RS485 Parity selection", "RS485 baud rate".

Pressing the **↑** key allows the user to set different Communication parameters.
(see section 3.2.2.1 to 3.2.2.3)

Pressing the **↓** key will advance to Reset parameter Screen.(see section 3.2.3)

3.2.3 Reset Parameter selection screen

SEL **rSEL** **PARrA**

This screen is used to Reset the different parameters.

Pressing the **↑** key allows the user to Reset different system parameters (see section 3.2.3.1)

Pressing the **↓** key will advance to Output Option selection screen (see section 3.2.4).

3.2.4 Output Option selection screen

SEL **out** **PARrA**

This screen will allow the user to select Output option Like "Relay" Output.

Pressing the **↑** key allows the user to select & Configure the output option. (see section 3.2.4.1)

Pressing the **↓** key will advance to User Assignable Feature Selection screen.
(see section 3.2.5)

3.2.5 User Assignable Feature Selection screen

SEL **USER** **PARrA**

This screen will allow the user to access different features like "Backlit", "User assignable screens".

Pressing the **↑** key will allow the user to select & configure the features.(see section 3.2.5.1)

Pressing the **↓** key will advance to Quit screen. (see section 3.2.6)

3.2.6 Quit screen

SEL **Quit** **PARrA**

This screen will allow the user to Quit the Menu.

Pressing the **↑** key will allow the user to Quit from menu & return to measurement screen.

Pressing the **↓** key will advance to System Parameter Selection screen (see section 3.2.1)

3.2.1 System parameters Selection 3.2.1.1 System Type

SYSt **4**

This screen is used to set the system type(only for 3 phase). System type "3" for 3 phase 3 wire, "4" for 3 phase 4 wire system & "1" for single phase system.

Pressing the **↑** key accepts the present value and advances to the "Potential transformer primary value Edit" menu. (see section 3.2.1.2)

Pressing the  key will enter the system type edit mode & scroll through the values available.

Pressing the  key advances to the system type confirmation menu.

System Type Confirmation



This screen will only appear following the edit of system type.

Pressing the  key sets the displayed value and will advance to "Potential Transformer Primary Value Edit" menu. (See section 3.2.1.2)

Pressing the  key will return to the system type edit stage.

NOTE: Default value is set to '4' i.e. 3P 4W.

3.2.1.2 Potential Transformer Primary Value

The nominal full scale voltage which will be displayed as the **Line to Line** voltages for all system types.

The values displayed represent the voltage in **kilovolts** (note "K" symbol).

Pressing the  key accepts the present value and advances to the "potential Transformer secondary Value Edit" menu. (See Section 3.2.1.3)



Pressing the  key will enter the "Potential Transformer Primary Value Edit" mode.

Initially the "multiplier must be selected, pressing the  key will move the decimal point position to the right until it reaches ###.#. after which it will return to #.###.

Pressing the  key accepts the present multiplier (decimal point position) and advances to the "potential Transformer primary Digit Edit" mode.

Potential Transformer Primary Digit Edit



Pressing the  key will scroll the value of the most significant digit from 0 through to 9 unless the

presently displayed Potential Transformer Primary Value together with the Current Transformer Primary Value, previously set, would result in a maximum system power of greater than 3000 MVA (1000 MVA per phase) in which case the digit range will be restricted.

Pressing the  key accepts the present value at the cursor position and advances the cursor to the next less significant digit.

The PT Primary value can be set from 100 VL-L to 1200 kV-L. The value will be forced to 100 VL-L if set less than 100.

Note: the flashing decimal point indicates the cursor position, a steady decimal point will be present to identify the scaling of the number until the cursor position coincides with the steady decimal point position. At this stage the decimal point will flash.

When the least significant digit has been set pressing the  key will advance to the "Potential Transformer Primary Value Confirmation" screen showing display of 0.120 kV i.e. 120 Volts indicating steady decimal point and cursor flashing at the "hundreds of volts" position.

Note :

1. PT Values must be set as Line to Line Voltage for Primary as Well as Secondary for all system types (3P3W/3P4W/1P2W).
2. Default value is set as System Input Voltage.

Potential Transformer Primary Value Confirmation



This screen will only appear following an edit of the Potential Transformer Primary Value.

If the scaling is not correct, pressing the \downarrow key will return to the "Potential Transformer Primary Value Edit" stage with the digits flashing indicating that the multiplier (decimal point position) should be selected.

Pressing the \uparrow key sets the displayed value and will advance to the Potential Transformer secondary Value (See Section 3.2.1.3)

3.2.1.3 Potential Transformer Secondary Value

The value must be set to the nominal full scale secondary voltage which will be obtained from the Transformer when the potential transformer (PT) primary is supplied with the voltage defined in 3.2.1.2 Potential Transformer Primary voltage.

The ratio of full scale primary to full scale secondary is defined as the transformer ratio.

The PT Secondary value can be set from 100VL-L to 500VL-L.



Pressing the \uparrow key accepts the present value and advances to the "Current Transformer Primary Value edit" menu. (See Section 3.2.1.4)

Pressing the \downarrow key will enter the "Potential Transformer Secondary Value Edit" mode. \downarrow key will scroll the value of the most significant digit from available range of PT secondary value. Please refer the table below for different ranges.

Pressing the \uparrow key accepts the present value at the cursor position and advances the cursor to the next less significant digit.

Note : the flashing decimal point indicates the cursor position, a steady decimal point will be present to identify the scaling of the number until the cursor position coincides with the steady decimal point position. At this stage the decimal point will flash

When the least significant digit has been set, pressing the \uparrow key will advance to the "Potential Transformer secondary Value Confirmation" stage.

Potential Transformer Secondary Value Confirmation



This screen will only appear following an edit of the Potential Transformer Secondary Value .

If the scaling is not correct, pressing the \downarrow key will return to the "Potential Transformer Secondary Value Edit" menu.

Pressing the \uparrow key sets the displayed value and will advance to the Current Transformer Primary Value. (See Section 3.2.1.4)

3.2.1.4 Current Transformer Primary Value

The nominal Full Scale Current that will be displayed as the Line currents. This screen enables the user to display the Line currents inclusive of any transformer ratios, the values displayed represent the Current in Amps.

Pressing the **↑** key accepts the present value and advances to the Current Transformer secondary Value (See Section 3.2.1.5)

Pressing the **↓** key will enter the "Current Transformer Primary Value Edit" mode.

This will scroll the value of the most significant digit from 0 through to 9, unless the presently displayed Current Transformer Primary Value together with the Potential Transformer Primary Value results in a maximum system power of greater than 3000 MVA (1000 MVA per phase) in which case the digit range will be restricted, the value will wrap.

Example: If primary value of PT is set as 1200 kVL-L (max value) then primary value of Current is restricted to 1002 A.

Pressing the **↑** key will advance to the next less significant digit. (* Denotes that decimal point will be flashing).

The "Maximum Power" restriction of 3000 MVA refers to 120% of nominal current and 120% of nominal voltage, i.e, 2083.3 MVA nominal power per phase.

When the least significant digit has been set, pressing the **↑** key will advance to the "Current Transformer Primary Value Confirmation" stage.

The minimum value allowed is 1, the value will be forced to 1 if the display contains zero when the **↑** key is pressed.

Current Transformer Primary Value Confirmation

This screen will only appear following an edit of the Current Transformer Primary Value.

If the scaling is not correct, Pressing the **↓** key will return to the "Current Transformer Primary Value Edit" stage with the most significant digit highlighted (associated decimal point flashing) and the bottom line of the display will be blanked.

Pressing the **↑** key sets the displayed value and will advance to the "Current Transformer Secondary Value Edit" menu. (See Section 3.2.1.5)

NOTE: Default value is set to '5' i.e. 5A.

3.2.1.5 Current Transformer Secondary Value

This screen is used to set the secondary value for Current Transformer. Secondary value "5" for 5A or "1" for 1A can be selected.

Pressing **↑** key accepts the present value and advances to the Demand integration Time (See Section 3.2.1.6)

Pressing the **↓** key will enter the CT Secondary value edit mode and scroll the value through the values available.

Pressing the **↑** key will advance to the CT Secondary Value Confirmation screen.

CT Secondary Value Confirmation

This screen will only appear following an edit of CT secondary value. If secondary value shown is not correct,

pressing the **↓** key will return to CT secondary edit stage.

Pressing **↑** key sets the displayed value and will advance to Demand Integration Time Edit menu.
(See Section 3.2.1.6)

3.2.1.6 Demand Integration Time

This screen is used to set the period over which current and power readings are to be integrated. The Unit of displayed values is minutes.



Pressing the **↓** key will scroll through the following Options 8,15,20,30.

Pressing the **↑** key will advance to Demand Integration confirmation screen.

Demand Integration Time value confirmation



Pressing **↑** key sets the displayed value and will advance to Auto Scroll screen.
(See Section 3.2.1.7)

NOTE: Default value is set to '8' i.e. 8 min.

3.2.1.7 Auto Scrolling :

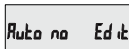

This screen allows user to enable screen scrolling.

Pressing **↑** key accepts the present status and advance to the Low Current Noise Cutoff selection.
(See Section 3.2.1.8).

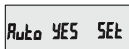

Pressing the **↓** key will enter the "Auto Screen Scrolling Edit" and toggle the status 'Yes' and 'No'.

Pressing the **↑** key will select the status displayed and advance to the Low Current Noise Cutoff selection. (See Section 3.2.1.8)

NOTE: Default value is set to 'NO'.

3.2.1.8 Low Current Noise Cutoff

This screen allows the user to set Low noise current cutoff in mA.

Low Current Cutoff Edit

Pressing **↑** key accepts the present value and advance to No. of Poles selection.
(See section 3.2.1.9)



Pressing the **↓** key will enter the "Low current noise cutoff Edit" mode and scroll the "Value" through 0 & 30 and wrapping back to 0. Setting 30 will display measured currents as 0 below 30 mA.

Low current noise cutoff Confirmation



Pressing the **↓** key will re-enter the "Low current Noise cutoff Edit" mode.

Pressing **↑** key will set displayed value and advance to the No. of Poles selection.
(See section 3.2.1.9)

NOTE: Default value is set as '0'.

3.2.1.9 No. of Poles Selection

This screen enables to set No. of poles of a Generator of which RPM is to be measured and to which the instrument is connected to monitor its parameters.

Selection of No. of poles of the Generator

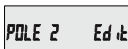



Pressing **↑** key accepts the present value and advance to Energy Output menu.
(See section 3.2.1.10)

Pressing the **↓** key will enter the "No. of Poles selection" mode and scroll the number from 2 to 40 in steps of 2. After 40 it scrolls the number back to 2.

No. of poles Confirmation

POLE 4 SET

Pressing the  key will re-enter the "No. of Poles Selection" mode.

Pressing  key set the number on screen as number of poles of generator & advance to "Energy Resolution" menu. (See section 3.2.1.10)

NOTE: Default value is set to '2'.

3.2.1.10. Energy Output

This screen enables user to set energy in terms of Wh / kWh / MKWh as per the requirement . Same is applicable to all types of energy.

Pressing  key accepts the presents value and advances to the "Energy Digit Reset Count" menu. (See section 3.2.1.11).

ENOP 2 Edit

Pressing the  key will enter the "Energy Output Edit" mode and scroll through the values 1,2 & 3 wrapping back to 1.

- 1 : Energy In Wh
- 2 : Energy in KWh
- 3 : Energy in MWh.

Pressing the  key advances to the "Energy Output Confirmation" menu.

Energy Output Confirmation

ENOP 3 SET

This screen will only appear following an edit of the Energy Output.

Pressing the  key will enter the "Energy Output Edit" stage.

Pressing  key sets the displayed value and will advance to the "Energy Digit Reset Count" menu. (See section 3.2.1.11)

- Note :** 1. Default value is set to '2' i.e. Energy will be in terms of kWh/kVArh/kVAH resp.
2. If $(PT \text{ primary}(VLL) * CT \text{ primary} * \text{Root}3) > 30000 \text{ kW}$, then Energy Output can be set only as kWh and MWh.
3. Old Energy is stored as per Energy Output only.

3.2.1.11 Energy Digit Reset Count :

This screen enables user for setting maximum energy count after which energy will roll over to zero depending on setting of Wh,KWh, & MWh.

Pressing the  key accepts the present value and will advance to the "Energy Rate" menu. (See Section 3.2.1.12)

Edrc 8

Pressing the  key will enter the Energy Digit Reset Count edit mode. This will scroll the value of reset count from 7 to 9.

Ex. If Energy Digit count is set to 9 then energy will reset after "999,999,999" & rollback to zero.

Pressing  key will advance to Energy Digit Reset Count confirmation screen.

Pressing the  key will re-enter Energy Digit Reset Count edit mode.

Pressing the  key sets the displayed value and will advance to the "Energy Rate" menu.

(See Section 3.2.1.12)

Note: Default value is set to '8' i.e. if energy count crosses 8 digits, then it will reset and rollback to zero.

3.2.1.12 Energy Rate :

This screen allows user to enter energy update rate in min. After entering particular value in min. the energy will be updated on modbus location from 30145 to 30153 of 3X register and 44241 to 44249 of 4X register as per value that user has entered.

Pressing the "↑" key accepts the present value and will jump back to System Parameter selection. (See Section 3.2.1)



Enrt 2

Pressing the "↓" key will enter the Energy Rate edit mode. This will scroll the count in minutes from 1 to 60.

Ex. If Energy Rate is set to 2 then energy will get stored after 2 minutes.

Pressing "↑" key will advance to Energy Digit Reset Count confirmation screen.

Pressing the "↓" key will re-enter Energy Digit Reset Count edit mode.

Pressing the "↑" key sets the displayed value and will jump back to System Parameter selection. (See Section 3.2.1)

NOTE: Default value is set to '15' i.e. 15 min.

3.2.2 Communication Parameter Selection :

3.2.2.1 Address Setting :



Addr 001 Edt

This screen applies to the RS 485 output only. This screen allows the user to set RS 485 address for the meter.

The allowable range of addresses is 1 to 247. When entering new address, it will prompt for first digit. (* Denotes that decimal point will be flashing). Press the "↓" key to scroll the value of the first digit.

Press the "↑" key to advance to next digit. Similarly, Enter second and third digits of address. After entering third digit, press "↑" key to advance to Address Confirmation screen.

Address confirmation Screen



Addr 111 SEt

This Screen confirms the Address set by user. Press the "↑" key to advance to next Screen "Rs485 Baud Rate" (See Section 3.2.2.2).

Pressing the "↓" key will re-enter the "Address Edit" mode.

3.2.2.2 RS 485 Baud Rate :



br 96

This screen allows the user to set Baud Rate of RS 485 port. The values displayed on screen are in kbaud.

Pressing "↑" key accepts the present value and advance to the Parity Selection (See Section 3.2.2.3).

Pressing the "↓" key will enter the "Baud Rate Edit" mode and scroll the value through 4.8, 9.6, 19.2, 38.4 & back to 4.8.

Pressing the "↑" key will select the value and advances to the Parity Selection (See Section 3.2.2.3).

NOTE: Default value is set to '9.6'.

3.2.2.3 RS 485 Parity Selection:

This screen allows the user to set Parity & number of stop bits of RS 485 port.

Pr no 1

Pressing  key accepts the present value and advance to Communication Parameter selection screen. (see section 3.2.2)

Pressing the  key will enter the "Parity & Stop bit Edit" mode & scroll the value through

odd : odd parity with one stop bit
no 1 : no parity with one stop bit
no 2 : no parity with two stop bit
E : even parity with one stop bit

Pressing the  key will set the value.

Pressing the  key again will jump back to the Communication Parameter selection menu (see section 3.2.2).

NOTE: Default value is set as 'no 1'.

3.2.3 Reset Parameter Selection :

3.2.3.1 Resetting Parameter

This screen allows the users to reset Energy, Lo(Min), hi(Max), Demand, Run hour, On hour, No. of Interrupts.

After Reset, the current value of the parameters are shown on their respective OLD screens.

rSEt none

Reset (None)

Pressing  key advances to Reset Parameter selection screen. (see section 3.2.3)

Pressing the  key will enter the "Reset option" mode & scroll through the parameter given below-

ALL : reset all resettable parameters

d : reset all demand parameters

E : reset all energies

Hi : reset maximum values of voltage & current

Lo : reset minimum values of voltage & current

hr : reset run hour & on hour

intr : reset no. of auxiliary supply interruption count

Pressing the  key will select the value.

Pressing the  key again will jump back to the Communication Parameter selection menu (see section 3.2.2).

3.2.4. Output Option Selection menu

3.2.4.1 Configuration of Output

SEL rEL 1 out

This screen applies to the Relay Output option Selection.

Pressing  key will select the Relay 1 output selection menu (See section 3.2.4.1.1).

Pressing the  key will advance to the Relay 2 output option.

SEL rEL 2 out

Pressing  key will advance to Assignment of Energy to Pulse Output (See section 3.2.4.1.1.1.1).

Pressing the  key will advance to the Quit screen. This screen allows the user to quit the output option.

SEL Quit out

Pressing  key will advance to the Output Parameter selection. (See section 3.2.4)

Pressing the  key will go back to Relay 1 output option. (See section 3.2.4.1).

3.2.4.1.1 Relay 1 & 2 Output Selection menu :

3.2.4.1.1.1 Pulse output :

rEL | PUL

This screen is used to assign Relay 1 & 2 in Pulse output mode.

Pressing "**↑**" key will advance to the Pulse output configuration. (See section 3.2.4.1.1.1.1)

Pressing "**↓**" key will show "Limit" output option. (See section 3.2.4.1.1.2)

3.2.4.1.1.2 Limit output :

rEL | Lt

This screen is used to assign Relay 1 in limit output mode.

Pressing "**↑**" key will Assign Limit output mode (See section 3.2.4.1.1.2.1).

Pressing the "**↓**" key will go back to the pulse option Screen. (See section 3.2.4.1.1.1)

3.2.4.1.1.1.1 Assignment of Energy to Pulse output :

This screen allows the user to assign pulse output to energy.

rEL | U-RC

Pressing "**↑**" key accepts the present setting and advance to "Pulse duration selection" (see section 3.2.4.1.1.1.2).

Pressing the "**↓**" key will enter into edit mode and scroll through the energy setting:

- U - AC : Active Energy Utility
- g - AC : Active Energy Generator
- U - rE : Reactive Energy Utility
- g - rE : Reactive Energy Generator
- U - AP : Apparent Energy Utility
- g - AP : Apparent Energy Generator

Pressing the "**↑**" key will set the value & advance to the "Pulse Duration Selection". (see section 3.2.4.1.1.1.2)

NOTE: Default value is set as 'U-AC'.

3.2.4.1.1.1.2 Pulse Duration Selection:

This screen applies only to the Pulse output mode of relay.

This screen allows the user to set Relay energization time in milliseconds.

Pulse Duration Edit

dur | 100

Pressing "**↑**" key accepts the present value and advance to Pulse Rate selection menu (see section 3.2.4.1.1.1.3).

Pressing the "**↓**" key will enter the "Pulse Duration Edit" mode and scroll the value through 60, 100, 200 and wrapping back to 60.

Pressing the "**↑**" key will select the value and advances to "Pulse Duration Confirmation".

Pressing the "**↑**" key again will set displayed value and advance to Pulse Rate selection menu. (See section 3.2.4.1.1.1.3)

NOTE: Default value is set to '100'.

3.2.4.1.1.1.3 Pulse Rate

This screen applies to the Relay Output option only. The screen allows user to set the Energy Pulse Rate divisor. Divisor values can be selected through 1, 10, 100, 1000 as per EnOP set. Refer **TABLE 3** for details.

rRt |

Pressing "**↑**" key accepts the present value and advances to the "Configuration of output" (See section 3.2.4.1).

Pressing the "↓" key will enter the "Pulse Rate Divisor Edit" mode & scroll the value through the values 1,10,100, 1000 wrapping back to 1. Pressing the "↑" key advances to the "Pulse Rate Divisor Confirmation" menu.

Pressing the "↓" key will return to the "Pulse rate Divisor Edit" stage.

Pressing the "↑" key sets the displayed value and will advance to the "Configuration of output". (See section 3.2.4.1)

3.2.4.1.1.2.1 Assignment of Limit output to parameter.

This screen is for Limit output mode selection. It allows the user to set Limit output corresponding measured value. Refer **TABLE 2** "Parameter for Limit output" for assignment.



rEL 1 000

Pressing the "↑" key accepts the present value and advance to the Limit Configuration select screen. (see section 3.2.4.1.1.2.2).

Pressing the "↓" key will enter the "Limit output Edit" mode and scroll the values, as per **TABLE 2**, "Parameter for Limit Output".

Pressing the "↑" key will advance to the Limit output confirmation screen.

Pressing the "↑" key sets the displayed value & will advance to the Limit Configuration select screen. (see section 3.2.4.1.1.2.2)

3.2.4.1.1.2.2 Limit Configuration select

This screen is used to set the Limit Configuration. Four different types of configuration can be selected:



LE1 Hi-E

Hi-E (High Alarm & Energized Relay)
Hi-d (High Alarm & De-Energized Relay)
Lo-E (Low Alarm & Energized Relay)
Lo-d (Low Alarm & De-Energized Relay)

(For details refer to section 10.2)

Pressing the "↑" key accepts the present value and advances to the "Trip Point selection" screen. (see section 3.2.4.1.1.2.3)

Pressing the "↓" key will enter the Limit Configuration edit mode and scroll through the modes available.

Pressing the "↑" key advances to the Limit Configuration type confirmation menu.

Pressing the "↑" key sets the displayed value & will advance to "Trip point selection" Screen. (See section 3.2.4.1.1.2.3)

NOTE: Default value is set to 'Hi-E'.

3.2.4.1.1.2.3 Trip point selection :

This screen applies to the Trip point selection. This screen allows the user to set Trip point for instruments.



LE1P 100 Ed 1

The allowable range is 10% to 120% for High Alarm 10% to 100% for Low Alarm. (refer **TABLE 2**).

Enter value, prompt for first digit. (* Denotes that digit will be flashing).

Press the "↓" key to scroll the values of the first digit.

Press the "↑" key to advance to next digit.

Similarly, enter second and third digits also.

Press **↩** to confirm and advance to "Hysteresis Selection" screen. (See section 3.2.4.1.1.2.4)
Pressing the **↵** key will return to Edit mode.

NOTE: Default value is set to '100'.

3.2.4.1.1.2.4 Hysteresis selection :

This screen applies to the Hysteresis selection.



This screen allows the user to set Hysteresis for relay output.

The allowable range is 0.5% to 50.0 % of Trip point.

Enter value, prompt for first digit.
(* Denotes that decimal point will be flashing).

Press the **↵** key to scroll the value of the first digit

Press the **↩** key to advance to next digit.

Hysteresis for Frequency is calculated as % of trip point span from 45 to 66 Hz. Eg. If trip point is 50% (55.5 Hz) and hysteresis is set to 10%, then relay will reset at 49.95 Hz [10% of 55.5 is 5.55 Hz. Hence, 55.5 - 5.55 = 49.95 Hz]

NOTE : In case of lo alarm if trip point is set at 100% then maximum 20% Hysteresis can be set.

Similarly, enter second and third digits also.

Press **↩** to confirm and advance to "Energizing Delay Time" screen. (See section 3.2.4.1.1.2.5)
Pressing the **↵** key will return to Edit mode.

NOTE: Default value is set to '50'.

3.2.4.1.1.2.5 Energizing Delay time

This screen allows the user to set Energizing Delay time in seconds for Relay Limit Assigned Parameters.



Pressing **↩** key accepts the present value and advance to De-energizing delay screen.

Pressing the **↵** key will enter the "Energizing Delay" Edit mode and scroll the "Value" through 1 to10.

Pressing **↩** key set displayed value & will advance to Assignment of De-energizing delay time. (See section 3.2.4.1.1.2.6)

NOTE: Default value is set to '1'.

3.2.4.1.1.2.6 De-Energizing Delay time

This screen allows the user to set De-Energizing Delay time in seconds for Relay Limit Assigned Parameters.



Pressing **↩** key accepts the present value and jumps back to Configuration of Output.
(See section 3.2.4.1)

Pressing the **↵** key will enter the "De-Energizing Delay" Edit mode and scroll the "Value" through 1 to10.

Pressing **↩** key set displayed value & will advance to Configuration of output. (See section 3.2.4.1)

NOTE: Default value is set to '1'.

3.2.5 User Assignable Features

3.2.5.1 Feature Selection Menu



This menu allows the user to scroll through different User Configurable features:

bCLt : backlit on/off

Scrn : user screen on/off

Pressing the **↵** key will scroll through the features backlit, user screen and quit.

Pressing **↑** key will select that particular option. (See section 3.2.5.1.1 or 3.2.5.1.2)
Selecting "Quit" option will return to "User Assignable Features" screen. (See section 3.2.5)

3.2.5.1.1 Backlit

backlit OFF

This screen allows the user to switch the backlight on or off.

Pressing the **↓** key will toggle between options "ON" and "OFF".

Pressing the **↑** key will select that particular option and jump back to "Feature Selection Menu". (See section 3.2.5.1)

NOTE: When backlight is switched 'Off', on pressing any key backlight will turn 'On' for 1 min. Default value is set to 'On'.

3.2.5.1.2 User Assignable Screens

This screen allows the user to turn On or Off the User Screen feature. Using this feature, the user can select any **FIVE / TEN** measurement screens of his choice and scroll through only those selected screens.

USER SCRn no

Pressing the **↓** key will toggle between options "no", "5" and "10".

5: Five userscreens
10: Ten userscreens

If "NO" option is selected by pressing **↓** key, then it will jump back to "Feature Selection Menu". (See section 3.2.5.1)

If "5" or "10" option is selected, then it will advance to "User Screen 1" selection screen.

NOTE: If User Screen feature is ON and System type is changed, then Active Energy screen (No. 8) is shown after exiting from setup.

User Screens Selection

Scr1 001

Pressing the **↑** key accepts the present value and advance to "User Screen 2" selection.

Pressing the **↓** key will enter the "User Screen" Edit mode and scroll through the screen numbers as per **TABLE 1** "Measurement Screens".

Pressing **↑** key will set the displayed value & advance to "User Screen 2" selection.

Similarly, enter the screen numbers for "User Screens 2 to 5 or 2 to 10" depending upon the selection.

After entering User Screen 10 value, pressing the **↑** key will jump back to "Feature Selection Menu". (See section 3.2.5.1)

4. Current Reversal screen

This screen is useful to indicate if current in any phase is reversed or not.

If current in any phase gets reversed, then corresponding phase will be indicated on this screen.

L1 L2 L3

This screen shows that currents in all three phase are reversed.

nonE

This screen shows that currents in all three phase are correct.

no curr inPt

This screen shows that the meter has no current input.

5. Phase Rotation Error screen

Meter shows phase rotation error if the phase sequence R-Y-B (L1-L2-L3) is not maintained or if any of the phase is absent.



This screen indicates that Phase Sequence is incorrect.

User must check this screen in order to get correct readings when meter is connected.



This screen indicates that Phase Sequence is correct.



This screen indicates that all three phases (voltages) are absent.

Note: In 3P3W, this screen is applicable only when load is balanced.

6. Phase Absent screen

This screen is useful to indicate if voltage or current in any phase is absent. Hence, user will know which voltage or current is missing and take corrective action.



This screen indicates that all three phases (voltage & current) are absent.



This screen indicates that V2, I2 and I3 are absent.



This screen indicates that all three phases are present i.e. all inputs are present.

7. Run Hour



This Screen shows the total no. of hours the load is connected. Even if the Auxiliary supply is interrupted,

count of Run hour will be maintained in internal memory & displayed in the format "hours. min". For example if Displayed count is 105000.10 it indicates 105000 hours & 10 minutes. After 999999.59 run hours display will restart from zero. To reset run hour manually see section Resetting Parameter 3.2.3.1

8. On Hour



This Screen shows the total no. of hours the Auxiliary Supply is ON. Even if the Auxiliary supply is interrupted,

count of On hour will be maintained in internal memory & displayed in the format "hours. min". For example if Displayed count is 105000.10 it indicates 105000 hours and 10 minutes. After 999999.59 On hours display will restart from zero. To reset On hour manually see section Resetting Parameter 3.2.3.1

9. Number of Interruption :



This Screen Displays the total no. of times the Auxiliary Supply was Interrupted. Even if the Auxiliary supply is interrupted count will be maintained in internal memory.

To reset No of Interruption manually see section Resetting Parameter 3.2.3.1.

TABLE 2 : Parameters for Limit output

Parameter No.	Parameter	3P 4W	3P 3W	1P 2W	Trip Point Set Range	100% Value
0	None	✓	✓	✓	—	—
1	Volts 1	✓	✓	✓	10 - 120 %	Vnom (L-N)
2	Volts 2	✓	✓	✗	10 - 120 %	Vnom (L-N)
3	Volts 3	✓	✓	✗	10 - 120 %	Vnom (L-N)
4	IL1	✓	✓	✓	10 - 120 %	Inom
5	IL2	✓	✓	✗	10 - 120 %	Inom
6	IL3	✓	✓	✗	10 - 120 %	Inom
7	W1	✓	✗	✓	10 - 120 %	Nom ⁽³⁾
8	W2	✓	✗	✗	10 - 120 %	Nom ⁽³⁾
9	W3	✓	✗	✗	10 - 120 %	Nom ⁽³⁾
10	VA1	✓	✗	✓	10 - 120 %	Nom ⁽³⁾
11	VA2	✓	✗	✗	10 - 120 %	Nom ⁽³⁾
12	VA3	✓	✗	✗	10 - 120 %	Nom ⁽³⁾
13	VAr1	✓	✗	✓	10 - 120 %	Nom ⁽³⁾
14	VAr2	✓	✗	✗	10 - 120 %	Nom ⁽³⁾
15	VAr3	✓	✗	✗	10 - 120 %	Nom ⁽³⁾
16	PF1 [#]	✓	✗	✓	10 - 90 %	90°
17	PF2 [#]	✓	✗	✗	10 - 90 %	90°
18	PF3 [#]	✓	✗	✗	10 - 90 %	90°
19	Pa1 [#]	✓	✗	✓	10 - 90 %	360°
20	Pa2 [#]	✓	✗	✗	10 - 90 %	360°
21	Pa3 [#]	✓	✗	✗	10 - 90 %	360°

Parameter No.	Parameter	3P 4W	3P 3W	1P 2W	Trip Point Set Range	100% Value
22	Volts Ave.	✓	✓	✗	10 - 120 %	Vnom ⁽²⁾
24	Current Ave.	✓	✓	✗	10 - 120 %	Inom
27	Watts sum	✓	✓	✗	10 - 120 %	Nom ⁽³⁾
29	VA sum	✓	✓	✗	10 - 120 %	Nom ⁽³⁾
31	VAr sum	✓	✓	✗	10 - 120 %	Nom ⁽³⁾
32	PF Ave.#	✓	✓	✗	10 - 90 %	90°
34	PA Ave.#	✓	✓	✗	10 - 90 %	360°
36	Freq.	✓	✓	✓	10 - 90 %	66 Hz ⁽¹⁾
43	Watt Demand Utility/Gen	✓	✓	✓	10 - 120 %	Nom ⁽³⁾
44	Watt Max Demand Utility	✓	✓	✓	10 - 120 %	Nom ⁽³⁾
46	Watt Max Demand Gen	✓	✓	✓	10 - 120 %	Nom ⁽³⁾
51	VA Demand Utility/Gen	✓	✓	✓	10 - 120 %	Nom ⁽³⁾
52	VA Max Demand Utility	✓	✓	✓	10 - 120 %	Nom ⁽³⁾
53	Current Demand Utility/Gen	✓	✓	✓	10 - 120 %	Inom
54	Current Max Demand Utility	✓	✓	✓	10 - 120 %	Inom
101	VL1-L2	✓	✗	✗	10 - 120 %	Vnom (L-L)
102	VL2-L3	✓	✗	✗	10 - 120 %	Vnom (L-L)
103	VL3-L1	✓	✗	✗	10 - 120 %	Vnom (L-L)
113	I Neutral	✓	✗	✗	10 - 120 %	Inom

Note : Parameters 1,2,3 are L-N Voltage for 3P 4W & L-L Voltage for 3P 3W.

- (1) For Frequency 0% corresponds to 45 Hz and 100% corresponds to 66 Hz.
- (2) For 3P 4W and 1Ph the nominal value is V_{L-N} and that for 3P 3W is V_{L-L} .
- (3) Nominal Value for power is calculated from Nominal Voltage and current values.
- (4) Nominal Value is to be considered with set CT/ PT Primary values.
- (5) For single phase L1 Phase values are to be considered as System values.

10. Relay output (Optional) :

The Meter is provided with relay for pulse output as well as for limit switch.

10.1 Pulse Output :

Pulse Output is the potential free, very fast acting relay contact which can be used to drive an external mechanical counter for energy measurement. The Pulse Output can be configured to any of the following parameter through setup parameter screen:

- 1) Active Energy Utility
- 2) Active Energy Generator
- 3) Reactive Energy Utility
- 4) Reactive Energy Generator
- 5) Apparent Energy Utility
- 6) Apparent Energy Generator

TABLE 3 : Energy Pulse Rate Divisor

1.For Energy Output in Whr

Divisor	Pulse rate	
	Pulse	System Power*
1	1 per Whr	Up to 3600 W
	1 per kWhr	Up to 3600 kW
	1 per MWhr	Above 3600 kW up to 30000 kW
	1 per 10Whr	Up to 3600 W
10	1 per 10kWhr	Up to 3600 kW
	1 per 10MWhr	Above 3600 kW up to 30000 kW
100	1 per 100Whr	Up to 3600 W
	1 per 100kWhr	Up to 3600 kW
	1 per 100MWhr	Above 3600 kW up to 30000 kW
	1 per 1000Whr	Up to 3600 W
1000	1 per 1000kWhr	Up to 3600 kW
	1 per 1000MWhr	Above 3600 kW up to 30000 kW

Pulse Duration 60 ms, 100 ms or 200 ms

2. For Energy Output in KWhr

Divisor	Pulse rate	
	Pulse	System Power*
1	1 per kWhr	Up to 3600 kW
	1 per MWhr	Above 3600 kW

3. For Energy Output in MWhr

Divisor	Pulse rate	
	Pulse	
1	1 per MWhr	

Above options are also applicable for Apparent and Reactive Energy.

*Note:

- 1) System power = $3 \times CT(\text{Primary}) \times PT(\text{Primary})$
L-N for 3 Phase 4 Wire
- 2) System power = $\text{Root}3 \times CT(\text{Primary}) \times PT(\text{Primary})$
L-L for 3 Phase 3 Wire
- 3) System power = $CT(\text{Primary}) \times PT(\text{Primary})$
L-N for 1 Phase 2 Wire

10.2 Limit Switch :

Limit switch can be used to monitor the measured parameter (Ref. **TABLE 2**) in relation with to a set limit. The limit switch can be configured in one of the four mode given below:-

- 1) Hi alarm & Energized Relay
- 2) Hi alarm & De-Energized Relay
- 3) Lo alarm & Energized Relay
- 4) Lo alarm & De-Energized Relay

With User selectable Trip point, Hysteresis, Energizing Delay & De-Energizing delay.

Hi Alarm:

If Hi-Alarm Energized or Hi Alarm De-Energized option is selected then relay will get energized or De-energized, if selected parameter is greater than or equal to trip point.

Lo Alarm:

If Lo-Alarm Energized or Lo Alarm De-Energized option is selected then relay will get energized or De-energized, if selected parameter is less than or equal to trip point.

Note: For Lo-Alarm configuration, set the values of trip point & hysteresis such that % trip point + % hysteresis should be less than 100%.

Example for Phase angle:

If trip point is set 70% then maximum applicable hysteresis is 42.8%. i.e Trip point 70% (252°) + Hysteresis 42.8% (107.8°) = 359.8°
 If total value is greater than the 100% i.e. 360° then relay will not release.

Example for PF:

For Hi-Alarm Energized, if trip point is 70% & hysteresis is 30%, then trip value = $0.7 \times 90^\circ = 63^\circ$.
 Tripping PF = $\cos(63) = 0.4539$ & hysteresis = $0.3 \times 0.4539 = 0.136$.

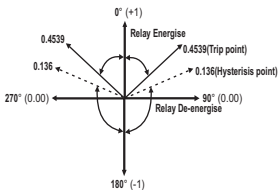

Hence, the relay will energize above 0.4539 and de-energize below 0.136.

Note: This function will work irrespective of +/- sign. It depends only on value.

Trip point:

Trip point can be set in the range as specified in **TABLE 2** of nominal value for Hi-Alarm & 10% to 100 % of nominal value for Lo-Alarm.

Hysteresis:

Hysteresis can be set in the range of 0.5% to 50 % of set trip point .

If Hi-alarm Energized or Hi-alarm De-energized is selected then relay will get De-energized or Energized respectively, if set parameter value is less than Hysteresis

Similarly if Lo-alarm Energized or Lo-alarm De-Energized.

Note : In case of lo alarm if trip point is set greater than 80% then the maximum hysteresis can be set such that the total Trip point+ Hysteresis(% of trip point value) will not exceed 120% of range.

For example :If trip point is set at 90%, then maximum 33.3% hysteresis should be set such that $[90 + 29.99 (33.3\% \text{ of } 90)] = 120$

Energizing Delay:

The energizing delay can be set in the range from 1 to 10 sec.

De-Energizing Delay:

The De-energizing delay can be set in the range from 1 to 10 sec.

Examples of different configurations

Parameter No. 4 (Current1)

Trip Point = 50%

Hysteresis = 50% of trip point

Enersing Delay: 2S

De-ensing Delay: 2S

1) Hi alarm & Energised relay

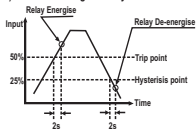

3) Lo alarm & Energised relay

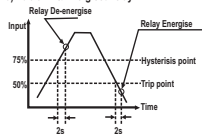

2) Hi alarm & De-energised relay

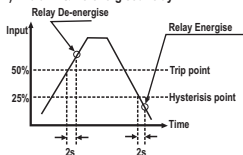

4) Lo alarm & De-energised relay

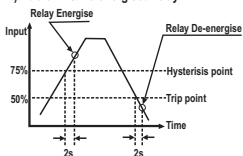

11. Phasor Diagram :

Quadrant 1: 0° to 90°

Quadrant 2: 90° to 180°

Quadrant 3: 180° to 270°

Quadrant 4: 270° to 360°

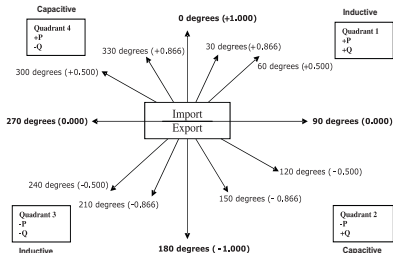

Connections	Quadrant	Sign of Active Power (P)	Sign of Reactive Power (Q)	Sign of Power Factor (PF)	Inductive / Capacitive
Import	1	+ P	+ Q	+	L
Import	4	+ P	- Q	+	C
Export	2	- P	+ Q	-	C
Export	3	- P	- Q	-	L

Inductive means Current lags Voltage

Capacitive means Current leads Voltage

When Multifunction Meter displays Active power (P) with " + " (positive sign), the connection is " **Import** " .

When Multifunction Meter displays Active power (P) with " - " (negative sign), the connection is " **Export** " .

12. Installation

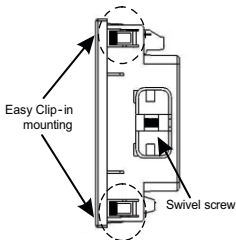

Panel Thickness : 1 - 3mm for self clicking,

1 - 6mm for swivel screws

Caution

1. In the interest of safety and functionality this product must be installed by a qualified engineer abiding by any local regulations.
2. Voltages dangerous to human life are present at some of the terminal connections of this unit. Ensure that all supplies are de-energised before attempting any connection or disconnection.
3. These products do not have internal fuses therefore external fuses must be used to ensure safety under fault conditions.

Mounting of the Meter is featured with easy "Clip-in" mounting. Push the meter in panel slot (size 92 x92 mm), it will click fit into panel with the four integral retention clips on two sides of meter. If required, additional support is provided with swivel screws as shown in figure.

The front of the enclosure conforms to IP50. Additional protection to the panel may be obtained by the use of an Optional panel gasket. The terminals at the rear of the product should be protected from liquids.

The Meter should be mounted in a reasonably stable ambient temperature and where the operating temperature is within the range 0 to 50°C. Vibration should be kept to a minimum and the product should not be mounted where it will be subjected to excessive direct sunlight.

12.1 EMC Installation Requirements

This product has been designed to meet the certification of the EU directives when installed to a good code of practice for EMC in industrial environments, e.g.

1. Screened output and low signal input leads or have provision for fitting RF suppression components, such as ferrite absorbers, line filters etc., in the event that RF fields cause problems.

Note: It is good practice to install sensitive electronic instruments that are performing critical functions, in EMC enclosures that protect against electrical interference which could cause a disturbance in function.

2. Avoid routing leads alongside cables and products that are, or could be, a source of interference.
3. To protect the product against permanent damage, surge transients must be limited to 2kV pk. It is good EMC practice to suppress differential surges to 2kV at the source. The unit has been designed to automatically recover in the event of a high level of transients. In extreme circumstances it may be necessary to temporarily disconnect the auxiliary supply for a period of greater than 5 seconds to restore correct operation. The Current inputs of these products are designed for connection in to systems via Current Transformers only, where one side is grounded.
4. ESD precautions must be taken at all times when handling this product.

12.2 Case Dimension & Panel Cut Out

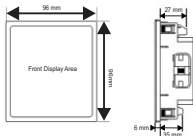

With optional MODBUS / Limit switch.

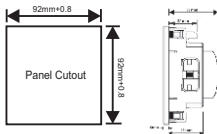

12.3 Wiring

Input connections are made directly to screw-type terminals with indirect wire pressure. Numbering is clearly marked on the connector. Choice of cable should meet local regulations. Terminal for both Current and Voltage inputs will accept upto 4mm² (12AWG) solid or 2.5 mm² stranded cable.

Note : It is recommended to use wire with lug for connection with meter.

12.4 Auxiliary Supply

Meter should ideally be powered from a dedicated supply, however powered from the signal source, provided the source remains within it may be the limits of the Chosen auxiliary voltage range.

12.5 Fusing

It is recommended that all voltage lines are fitted with 1 Amp HRC fuse.

12.6 Earth/Ground Connections

For safety reasons, CT secondary connections should be grounded in accordance with local regulations.

13. Connection Diagrams

3-PHASE 3-WIRE UNBALANCED LOAD
DIGITAL METERING SYSTEM (WITH EXTERNAL AUX.)

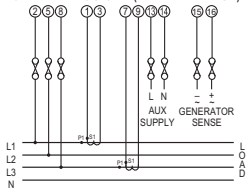

3-PHASE 4-WIRE UNBALANCED LOAD
DIGITAL METERING SYSTEM (WITH EXTERNAL AUX.)

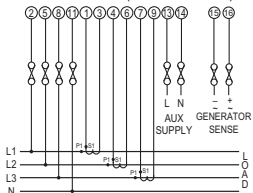

SINGLE PHASE 2-WIRE
DIGITAL METERING SYSTEM (WITH EXTERNAL AUX.)

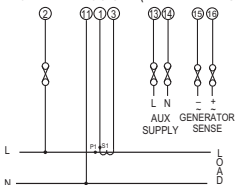

14. Optional Pluggable Module

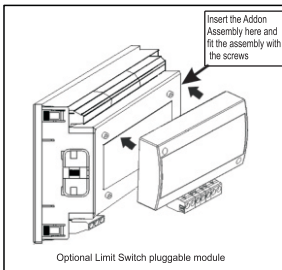

15. Specification :

System

3 Phase 3 Wire / 4 Wire or Single
Phase programmable at site

Inputs

Nominal Input Voltage 100 V_{L-L} to 500 V_{L-L}
57.7 V_{L-N} to 290 V_{L-N}

System PT Primary Values 100 V_{L-L} to 1200 kV_{L-L} ,
programmable at site

System PT Secondary Values 100 V_{L-L} to 500 V_{L-L}
programmable at site

Max continuous input voltage 120% of Nominal Value

Nominal input voltage burden <0.3 VA approx.
per Phase

Nominal Input Current 1A / 5A AC RMS

max continuous input current 120% of Nominal value

Nominal input current burden <0.3 VA approx.
per phase

SystemCT primary values Std. Values 1 to
9999A (1 or 5 Amp secondary)

System Secondary Values 1A / 5A,
programmable at site

Overload Indication "-OL-"
>121% of Nominal value
(for voltage and current)

Overload withstand

Voltage input 2 x Rated Value
(1s application repeated 10 times
at 10s intervals)

Current input 20 x I_{max} for 0.5sec

Auxiliary Supply

Higher 60V to 300V AC/DC
Auxiliary Supply (+/- 5% approx.)

Nominal Value 230V AC/DC
50/60 Hz for AC Aux
OR

Lower 20V to 60V DC /

Auxiliary Supply 20V to 40V AC

Nominal Value 48V DC /
24 V AC 50/60 Hz

Frequency Range 45 to 65 Hz

VA Burden
With Addon card < 6 VA approx.
Without Addon card < 4 VA approx.

Generator Sense

AC Voltage 20-300 VAC
DC Voltage 10-60 VDC

Operating Measuring Ranges

Voltage with external Aux. 50 ... 120 % of
Nominal Value
Current 1A - 20mA to 1.2A
5A - 100mA to 6A

Starting Current 1A - 2mA
(As per IEC 62053-21) 5A - 10mA

Frequency 50 Hz / 60 Hz
Power Factor 0.5 Lag ... 1 ... 0.8 Lead
Total Harmonic Distortion 0...50%

Reference conditions for Accuracy

Reference temperature $23^{\circ}\text{C} \pm 2^{\circ}\text{C}$
 (as per IEC 62053-21)

Accuracy

Voltage	$\pm 0.5\%$ of Nominal Value
Current	$\pm 0.5\%$ of Nominal Value
Frequency	$\pm 0.2\%$ of mid frequency
Active power	$\pm 0.5\%$ of Nominal Value at $\cos \phi = 1$
Reactive power	$\pm 1.0\%$ of Nominal Value at $\sin \phi = 1$
Apparent Power	$\pm 0.5\%$ of Nominal Value
Power Factor / Phase Angle	$\pm 3^{\circ}$
Active energy	class 1 as per IEC 62053-21
Reactive energy	class 2 as per IEC 62053-23
Apparent energy	class 1
THD (Voltage / Current)	$\pm 2\%$

Note: Variation due to influence quantity is 100% of class index for all other parameters except energy.

Display

LCD Display with backlight
 Update rate Approx. 1 sec.

Controls

User Interface 2 push buttons

Standards

EMC Immunity	IEC 61000-4-3 10V/m - Level 3 Industrial Low Level
EMC Emission	IEC 61326-1
Safety	IEC 61010-1-2010, permanently connected use
IP for water & dust	IEC 60529
Pollution degree	2
Installation Category	III

Isolation

Protective Class	2
High Voltage Test	
Input+Aux vs Surface	4 kV RMS, 50Hz, 1 min
Input vs Remaining Circuit	2 kV RMS, 50Hz, 1 min

Environmental conditions

Operating temperature	-10 to +55 °C
Storage temperature	-20 to +65 °C
Relative humidity	0 .. 90 % RH (Non condensing)
Warm up time	3 minute (minimum)
Shock (As per IEC 60068-2-27)	Half Sine wave, Peak acceleration 30gn (300 m/s ²), duration 18 ms
Vibration	10..150..10 Hz, 0.15mm amplitude
Number of Sweep cycles	10 per axis

Enclosure		100	1 per 100Wh (up to 3600W),
Enclosure front	IP 50		1 per 100kWh (up to 3600 kW),
Enclosure front with seal (optional)	IP 65		1 per 100MWh (above 3600 kW up to 30000 kW)
Enclosure back	IP 20		
Dimensions			
Bezel Size	96mm x 96mm DIN 43718		
Panel cut out	92 ^{+0.8} mm X 92 ^{+0.8} mm	1000	1 per 1000Wh (up to 3600W),
Overall Depth	55 mm		1 per 1000kWh (up to 3600kW),
Panel thickness	1 - 3mm for self clicking 1 - 6mm for swivel screws		1 per 1000MWh (above 3600 kW up to 30000 kW)
Weight	320 grams Approx.		
Pulse output Option			
Relay	1NO	Pulse Duration	60ms , 100ms or 200ms
Switching Voltage & Current	240 VAC , 5 A.		
Default Pulse rate Divisor	1 per Wh (up to 3600W), 1 per kWh (up to 3600kW), 1 per MWh (above 3600 kW up to 30000 kW)		
Pulse rate Divisors	Programmable on site		
10	1 per 10Wh (up to 3600W), 1 per 10kWh (up to 3600kW), 1 per 10MWh (above 3600 kW up to 30000 kW)		
		ModBus (RS 485) Option :	
		Protocol	ModBus (RS 485)
		Baud Rate	38400, 19200, 9600 or 4800 (Programmable)
		Parity	Odd or Even, with 1 stop bit, Or None with 1 or 2 stop bits
		Impulse Output :	
		Impulse Constant as per PT Secondary	
		100 to 125 VLL:	16000 impulse/kWh
		126 to 250 VLL:	8000 impulse/kWh
		251 to 500 VLL:	4000 impulse/kWh

16. Connection for Optional Pulse Output / RS 485 (rear view of Multifunction Meter):

1. One Pulse Output (Limit Output)

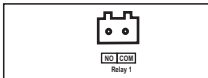

2. RS 485 Output

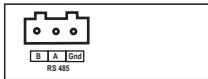

3. One Pulse (Limit) + RS 485 Output

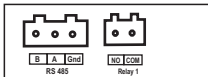

4. Two Pulse/limit Output

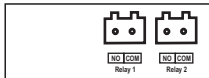

5. Two Pulse/limit + RS 485 Output

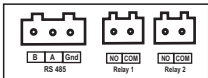

NOTE

The Information contained in these installation instructions is for use only by installers trained to make electrical power installations and is intended to describe the correct method of installation for this product. However, 'manufacturer' has no control over the field conditions which influence product installation.

It is the user's responsibility to determine the suitability of the installation method in the user's field conditions. 'manufacturer' only obligations are responsibility to determine the suitability of the installation method in the user's field conditions. 'manufacturer' only obligations are those in 'manufacturer' standard Conditions of Sale for this product and in no case will 'manufacturer' be liable for any other incidental, indirect or consequential damages arising from the use or misuse of the products.