

Power Factor Controller

RISH PFC 8

96 x 96

Operation Manual



CAUTIONS:

1. High voltage !
2. This controller may only be used indoor !
3. Make sure that the discharge time set in controller matches capacitor discharge time !

CONTENTS

Section 1	General
Section 2	Mechanical dimensions and panel cut out
Section 3	Installation and connection of the controller 3.1 Alarm output / Error messages
Section 4	Terminal details 4.1 96 x 96 4 relay model 4.2 96 x 96 6/8 relay model, MODBUS model
Section 5	Front screen
Section 6	Front screen capacitor symbols
Section 7	Keyboard
Section 8	Display of various electrical parameters
Section 9	Display operations
Section 10	basic settings

Section 11	Advanced settings
	11.1 System setup
	11.2 Manual setup
	11.3 Alarm setup
	11.4 Reset values
	11.5 Modbus setup
	11.6 Display setup
	11.7 Change password
Section 12	Service mode
Section 13	Technical data
Section 14	Factory default setting
Section 15	Operating diagram

Section1 General

The power factor controller is a modern control device of innovative design with a variety of functions. It is designed for a measuring voltage of 30...550V (L-N) or (L-L) and a auxillary supply voltage of 110 to 550 VAC.

It features a user interface with a menu-driven display in plain text for maximum ease of operation. Straight forward symbols and alphanumeric displays combine maximum ease of handling with convenient presentation of results.

Display of various grid parameters, storage of various values and a test run option make it easy to analyse errors and monitor the system.

Main features:

- P 1. Autoinitialisation function that detects connected capacitor kvar,
- P connected number of capacitor banks, input phase correction angle,
- P input voltage connection VLL or VLN
- 2. Various capacitor kvar selection option -
Direct value (Individual capacitor kvar),
Control series (programming of capacitor kvar ratio),
Auto detected capacitor kvar
- 3. 4/6/8 switching outputs
- P 4. Complete menu-guided operation and User interface
- P 5. Illuminated graphic display with 2 x 16 characters
- P 6. Four-quadrant operation
- P 7. RTC option with last three fault logs
- P 8. Display of various line parameters (V, I, F, Q, P, S...)
- P 9. Monitoring of the individual capacitor kvar

- P 10.Storage of maximum values, minimum values of line-parameter,
P switching-operation values as well as of the turn-on times of
P individual capacitor
- P 11.Programming of output
Programming of output as Auto, fixed and faulty. This option used
for skipping step from switching for PF correction
- P 12.Manual control
P Manual control allows switching of capacitor and contactor
P thus used for diagnosis purpose
- P 13.Error detection for various states and interference-message
P output Test run of PFC system with error analysis
- 14.Recall function of recorded values
- P 15.True RMS measurement upto 31st harmonics
- P 16.Display of individual voltage and current harmonics upto 31st
- P 17.Display of voltage and current total harmonics distortion
- P 18.Display and monitoring of temperature

PFC Configurations

Output relay Options	4 relays outputs, 1 alarm relay 6 relay outputs, 1 alarm relay 8 relays outputs, 1 alarm relay
Option RS485	Optional Interface RS 485 output
Option RTC	Optional Real Time Clock.

Section 2 Mechanical Dimensions :

96 model Without Add On card (Relay + Modbus)

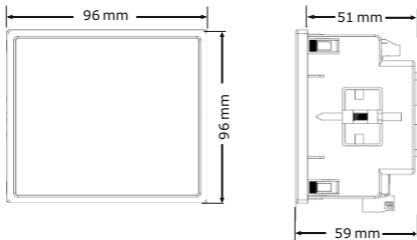

PFC 96 model With Add On card (Relay + Modbus)

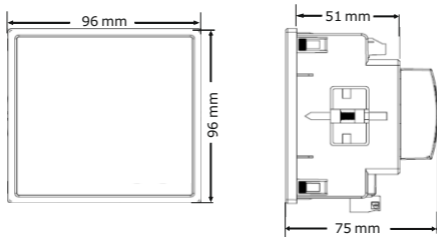

Panel Cutout for PFC 96 size model

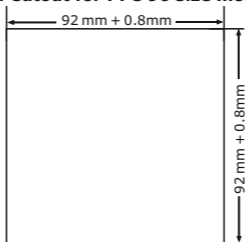

Optional Pluggable Module (Relay + Modbus)

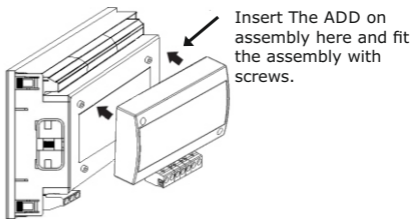

Section 3 Installation and connection of the controller

The controller is designed to be incorporated into the front panel of a PFC-cabinet. It requires a panel cutout of 92 x 92. The controller is inserted from the front and it gets fitted into panel with help of self clicking & if required swivel screw can be used. The controller should be installed by qualified technicians and must be operated in accordance with the specified safety regulations.

Mounting of the controller is featured with easy "Clip-in" mounting. Push the meter in panel slot, it will click fit into panel with the four integral retention clips on two sides of meter. If required, additional support is provided with swivel screws as shown in Fig. 1

Before the controller is connected up, all leads and cables must be checked to ensure that no current is flowing through them. Care should be taken to ensure that the measuring voltage and current are in the correct phase position. The connection should be set up as shown in Fig. 2. The specified safety regulations must be observed.

The auxiliary supply voltage is 110 to 550 VAC / DC

The measuring voltage may lie in the range from 30-550 VAC and can be connected as L-N or L-L. after voltage and current connections enter CT primary and secondary.

Now as per site conditions **Phase correction angle, voltage type, Capacitor bank KVAR , Number of capacitor banks** parameters can be set **OR** Auto initialisation can be carried out to detect above parameters.

Auto-initialisation function designed to works in most of practical load conditions and system networks. Refer Auto initialisation notes for detail.

if any ambiguity found in system values during or after autoinitialisation then settings for above can be done in basic settings and advanced system settings.

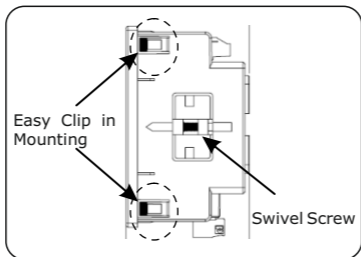

Fig 1: Installation

3.1 Alarm output / error messages

The alarm contact is open in normal operation and closed in the event of a fault. The relevant fault is simultaneously shown on the display in plain text. The following fault messages are displayed:

UNDERVOLTAGE	Display and relay output
OVERVOLTAGE	Display and relay output
UNDER FREQUENCY	Display and relay output
OVER FREQUENCY	Display and relay output
UNDER CURRENT	Display and relay output
OVER CURRENT	Display and relay output
VOLTAGE HARMONICS	Display and relay output
CURRENT HARMONICS	Display and relay output
OVER TEMPERATURE	Display and relay output
OUT OF BANK	Display and relay output
OVER COMPENSATION	Display and relay output

PFC 96X96 Electrical Connection

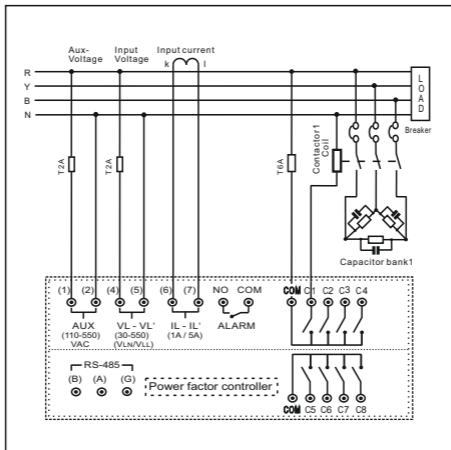
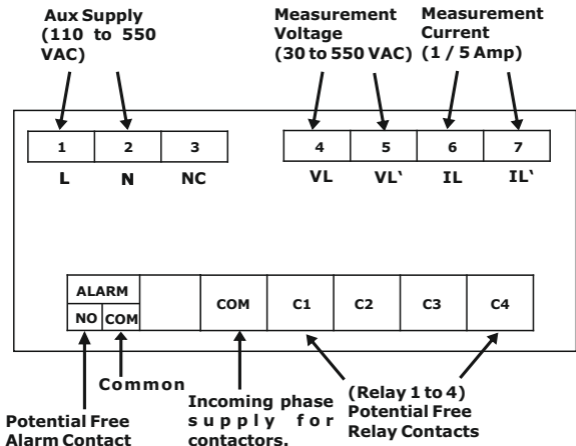

Fig 2: Connection Diagram

Section 4 Rear side Terminals

4.1 Without Add on Card (Relay + Modbus)



4.2 With Add on Card (Relay + Modbus)

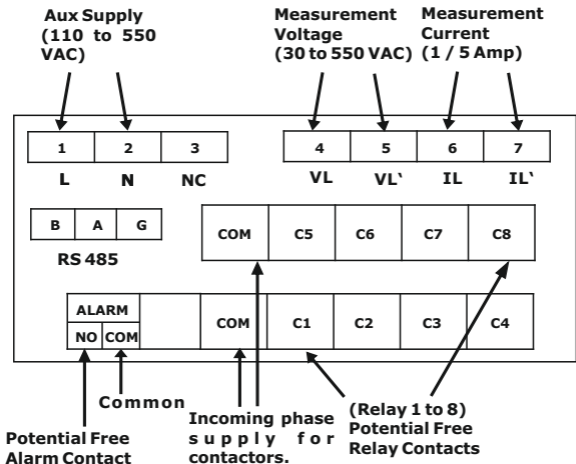

Section 5 Front Screen

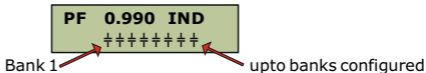

First line indicates the PF value, inductive / capacitive PF.

"PF = 0.999" indicates the overall PF of the system.

"IND" or "CAP" indicates inductive or capacitive respectively.

'-' sign to power factor indicates change in quadrant operation

Maximum 8 banks available with PFC 96

Meter toggles between PF screen, Fault status screen (if any fault exist).

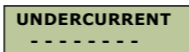

Fault status screen represent one out of following status :

- UNDERVOLTAGE
- OVERVOLTAGE
- UNDER FREQUENCY
- OVER FREQUENCY
- UNDER CURRENT
- OVER CURRENT
- OVER HARMONICS VOLTAGE
- OVER HARMONICS CURRENT
- OVER TEMPERATURE
- OUT OF BANK
- OVER COMPENSATION

Section 6 Front Screen capacitor symbols

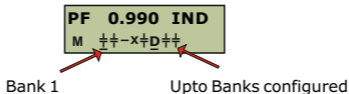

Label **M** in second line of display signifies that controller is in manual mode screen

Power Factor at Load sensing CT is 0.990 IND (Inductive).
(‘CAP’ defines Capacitive).

change in quadrant is indicated by minus sign appearing in-front of power factor value.

Total number of banks configured 8

Capacitor bank 1 is declared as fixed and is in ON condition.

Capacitor bank 2 is in ON condition (Auto mode).

Capacitor bank 3 is in Auto mode, OFF state and can be switched ON

Capacitor bank 4 is declared as faulty so in OFF condition.

Capacitor bank 5 is in ON condition (Auto mode).

Capacitor bank 6 is in discharging state.

Capacitor bank 7,8 is in ON condition (Auto mode).

if any faults is existing then PF and alternately fault screen appears on LCD.

Section 7 Keyboard

Keyboard with soft touch keys are provided on the front fascia of the controller. The various keys are:-



MENU Key. Pressing menu key will enter into program mode menu OR to return to previous menu / submenu / Return to main PF screen.

This key is denoted as **M** key in manual.



UP Key. Used to scroll up the menu screen and submenu screen, Increment values when entering numbers.

This key is denoted as **U** key in manual.



DOWN Key. Used to scroll down the menu and submenu screen, decrement values when entering numbers.

This key is denoted as **D** key in manual.



ENTER key. Used for entering a submenu or for confirming changes of entered values.

This key is denoted as **E** key in manual.

Section 8 Display of various electrical parameters:

Values of various electrical parameters can be viewed by using UP / Down keys.

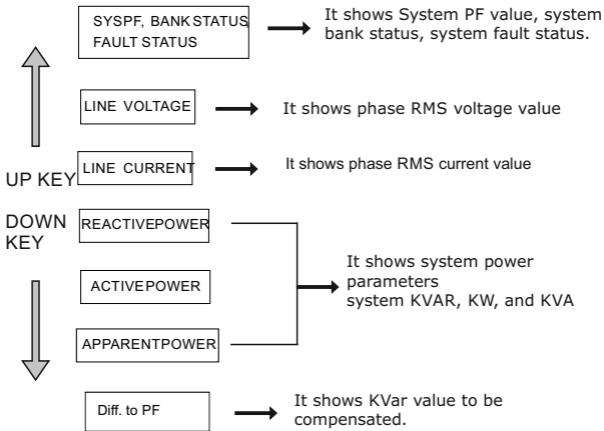

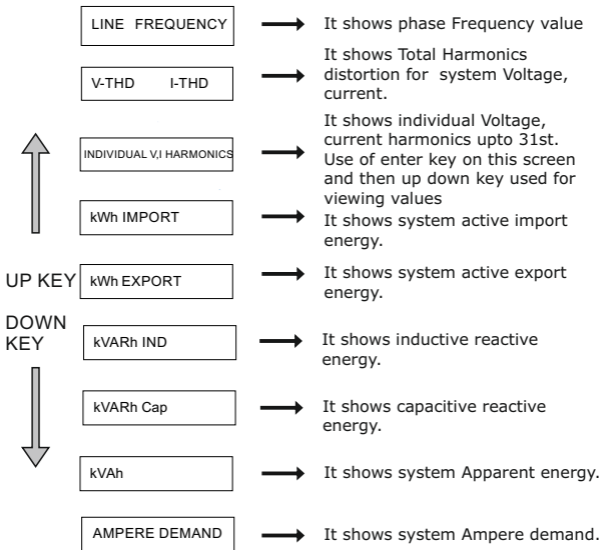

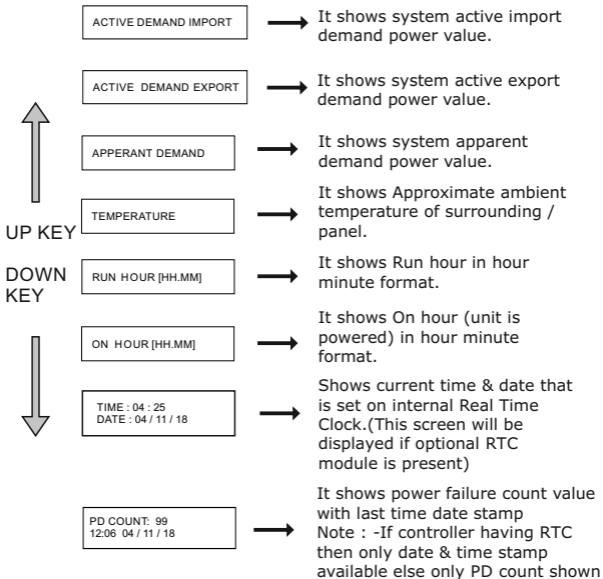

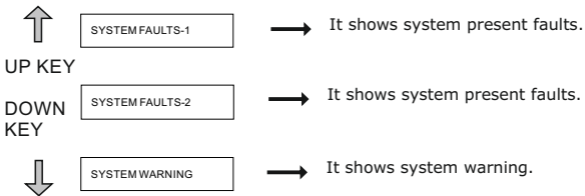

Section 9 Display Operations

PFC normally shows default screen of power factor, by using up / down key scrolling is possible for various system measured parameters.

Pressing menu key on other than default screen will show default screen first. use Up/ Down key to scroll measurement parameter. Auto scroll of display parameter with fixed scrolling time can also be enabled.

Upon pressing menu key on default screen will show three main menus namely Basic Setting, Advanced Setting, Service Modes.

Further navigation to settings is possible by using Up / Down key.

Enter key enables scrolling for various menu option and also, editing of parameters.

Section 10 BASIC SETTINGS

Press ENTER key to enter into Basic setting.

ENTER PASSWORD

ENTER PASSWORD : Password protection can be enabled to prevent unauthorised access to basic setting's sub-menus, by default password is set to 0000.

APFC allows user to set password in range 0000 to 9999. Password protection is enabled by selecting a four digit number other than 0000.

Password Setting:

To change password please refer section 11.7

CT PRIMARY

CT PRIMARY : This parameter allows user to set Current transformer's primary value. Value is settable from 0001 to 9999 Amp.

Press ENTER key to edit CT PRIMARY value.

Pressing UP or DOWN key will increment or decrement digit value. Then pressing ENTER key will advance to next digit & confirm newly changed values.

CT SECONDARY

CT SECONDARY : This parameter allows user to set Current transformer's secondary value. Value can be set as 1 or 5 Amp.

Press ENTER key to edit CT SECONDARY value.

Pressing UP or DOWN key will increment or decrement digit value. Then press ENTER key to confirm newly changed values.

Auto init : Enables auto initialization function
selecting YES option starts auto detection process

Proper CT primary and secondary should be set before starting auto init

AUTO INIT

Auto initialization detects voltage connection type LN or LL , system correction angle between inputs , carries out test run to detect capacitor KVAR and also detect number of connected capacitors. if undercurrent fault is present during auto init then auto init function gets aborted.

To successfully detect system type (LN,LL) voltage should be in range of 180V.to 550V, if 220/230/240 VLN system then system connection can be automatically detected ,if any other voltage ex. 110 VLL controller prompts to select connection type.

To successfully detect phase correction angle PF should be in range of 0.600 inductive to 0.999 inductive.

auto init starts with switch off all capacitors and after discharge time complete, phase correction angle and type is evaluated and shown on LCD, then capacitor KVAR detection starts, detected KVAR is displayed on LCD and these values can also be seen in service mode menu.

system type (LN or LL) detected get overwritten to present value whereas system angle stored in separate location (not overwritten).

if any discrepancy found in system type ,correction user can change to old values by appropriate settings in basic settings menu.if any capacitor detected 0 KVAR then that output marked as faulty and neglected in correction algorithm if any discrepancy found in KVAR detected or number of banks then appropriate settings to be carried out in basic settings.

SYS NOM VOLTAGE

SYSTEM NOMINAL VOLTAGE : This is the system rated voltage with respect to which the fault limits are calculated. Press ENTER key to edit system nominal value. Pressing UP or DOWN key will increment or decrement digit value. Then pressing ENTER key will advance to next digit & confirm newly changed values.

CAPACITOR KVAR

CAPACITOR KVAR: Assigns Capacitor KVAR for outputs. following 3 option possible

1. AUTO DETECTED: KVAR detected by auto detection function
2. DIRECT Kvar: Individual capacitor KVAR can be programmed independent of other capacitor banks
3. CONTROL SERIES. Predefined sequence is Ratio of capacitor KVAR with reference to first step

Press ENTER key to edit Capacitor KVAR selection option
Pressing UP or DOWN key will scroll available options
Then pressing ENTER key confirms the option

PHASE CORR. ANGLE

PHASE CORRECTION ANGLE: Selects phase correction angle for inputs applied following two options possible

1. AUTO DETECTED: phase correction angle as detected by auto detection function
2. USER SETTINGS: use correction angle as set in

Press ENTER key to edit phase correction angle
Pressing UP or DOWN key will scroll available options
Then pressing ENTER key confirms the option

Control Series: Control series is predefined sequence is ratio of capacitor KVAR with respect to first capacitor KVAR. there are 20 predefined control series any control series can be selected

Pressing UP or DOWN key will increment or decrement control series number. Then pressing ENTER key will confirm newly changed values

Control series1:1,1,1,1,1,1,1,1

Control series2:1,2,2,2,2,2,2,2

Control series3:1,2,3,3,3,3,3,3

Control series4:1,2,3,4,4,4,4,4

Control series5:1,2,4,4,4,4,4,4

Control series6:1,2,3,6,6,6,6,6

Control series7:1,2,4,8,8,8,8,8

Control series8:1,1,1,1,2,2,2,2

Control series9:1,1,1,1,1,6,6,6

Control series10:1,1,2,2,2,2,2,2

Control series11:1,1,2,2,2,4,4,4

Control series12:1,1,2,2,4,4,4,4

Control series13:1,1,1,1,2,2,2,2

Control series14:1,1,2,3,3,3,3,3

Control series15:1,1,2,4,4,4,4,4

Control series16:1,1,2,4,8,8,8,8

Control series17:1,2,2,3,3,3,3,3

Control series18:1,2,3,4,4,8,8,8

Control series19:1,2,2,4,4,4,4,4

Control series20:1,2,2,2,4,4,4,4

If connected capacitor kVAR to output relays not suitable for any of above control series then direct kvar option can be selected so that any value of capacitor kVAR can be set

CAP BANKS IN USE

CAP.BANKS IN USE :

There are 3 models with 4 / 6 / 8 relay options. user can set banks from 1 to n

(n = 4,6,8)as per ordered device.

if CAPACITOR KVAR option set as [AUTO DETECTED] then this option not available since number of banks are detected automatically.

Press ENTER key to edit bank kVAR values.

Pressing UP or DOWN key will increment or decrement digit value. Then pressing ENTER key will advance to next digit & confirm newly changed values.

CAP.[01] POWER

CAP.[01] POWER : user can program bank KVAR values in range 1 to 255 KVAR. Increments in steps of 0.5 KVAR.

if [CONTROL SER.] option is selected then only 1st capacitor KVAR need to set. next capacitor KVAR sets automatically

Ex if control series is 3 and CAP[01] set 5KVAR then

Capacitor1 KVAR is $5 \times 1 = 5$ KVAR

Capacitor2 KVAR is $5 \times 2 = 10$ KVAR

Capacitor3 KVAR is $5 \times 3 = 15$ KVAR

For [DIRECT KVAR] option all capacitor KVAR need to be entered in subsequent settings.

For [AUTO DETECTED] option capacitor KVAR automatically detected and set.

Press ENTER key to edit Capacitor KVAR power

Pressing UP or DOWN key will increment or decrement digit value. Then pressing ENTER key will confirm newly changed values.

CAP.[n] POWER

Section 11 ADVANCED SETTINGS

Press ENTER key to enter into Advance setting.

ENTER PASSWORD

ENTER PASSWORD : Password protection can be enabled to prevent unauthorised access to advanced setting's sub-menus, by default password is set to 0001.

PFC allows user to set password in range 0000 to 9999. Password protection is enabled by selecting a four digit number other than 0000.

Password Setting:

To change password please refer section 11.7

Section 11.1 : SYSTEM SETUP

This menu allows user to set one out of several system related setup parameters.

SYSTEMSETUP

Press ENTER key to enter into system setup sub menus. Pressing UP or DOWN key will scroll through submenus.

TARGET PF :This parameter is the target power factor of system. Value is settable from 0.8 INDUCTIVE to 0.8 CAPACITIVE.

TARGET PF

Press ENTER key to edit target PF. Pressing UP or DOWN key will increment or decrement digit value. Then pressing ENTER key will advance to next digit & confirm newly changed values.

SWITCH IN TIME :This parameter is the SWITCH-IN time of individual capacitor bank. Switch in time Value is settable from 10 to 1800 Sec.

SWITCH-IN-TIME

Press ENTER key to edit switch in time value. Pressing UP or DOWN key will increment or decrement digit value resp. Then pressing ENTER key will advance to next digit & confirm newly changed values.

SWITCH-OFF-TIME

SWITCH OFF TIME :This parameter is the SWITCH-OFF time of individual capacitor bank. Switch off time Value is settable from 10 to 1800 Sec.

Press ENTER key to edit Switch off time value. Pressing UP or DOWN key will increment or decrement digit value resp. Then pressing ENTER key will advance to next digit & confirm newly changed values.

DISCHARGE TIME

DISCHARGE TIME :This parameter is the discharge time of individual capacitor bank. discharge time Value is settable from 60 to 1800 Sec.

Press ENTER key to edit discharge time value. Pressing UP or DOWN key will increment or decrement digit value resp. Then pressing ENTER key will advance to next digit & confirm newly changed values.

THRESHOLD

THRESHOLD : Threshold for switching ON / OFF next stage. It should not be change in normal case

Threshold value is editable in range 30 to 100%.

Press ENTER key to edit threshold value. Pressing UP or DOWN key will increment or decrement digit value resp. Then pressing ENTER key will advance to next digit & confirm newly changed values.

SWITCHING OPERATION
WARNING COUNT

SWITCHING OPERATION WARNING COUNT :

After an output has performed this number of switching operations a warning message is displayed.

switching operation warning count is editable in range 10000 to 255000.

Warning will disappear if user resets switching operation count.

Press ENTER key to edit switching operation count.

Pressing UP or DOWN key will increment or decrement digit value resp. Then pressing ENTER key will advance to next digit & confirm newly changed values.

CAP HEALTH CHECK

Capacitor Health Check : The kvar of the particular capacitor bank is calculated during each switching operation and compared with stage output of capacitor. If the result value is below 80% and above 70 % of nominal value for a particular bank warning will be displayed & if it goes below 70% of nominal value that particular bank will get block. user can enable or disable this feature. The number of attempts for checking bank value are programable, refer "cap test attempt" count.

Press ENTER key to edit cap health check.

Press UP or DOWN key to get available options (yes /no) resp. Then pressing ENTER key will confirm newly changed options.

CAPACITOR TEST
ATTEMPTS COUNT

CAPACITOR TEST ATTEMPTS COUNT :

This parameter is programmable in range 5 to 9. when at least this number of successive measurement is resulted in fault in the capacitor power, Capacitor fault message will appear on display.

Press ENTER key to edit capacitor test attempt count. Pressing UP or DOWN key will increment or decrement digit value resp. Then pressing ENTER key will advance to next digit & confirm newly changed values.

SYSTEM FREQUENCY

SYSTEM FREQUENCY :

This parameter is settable as 50 or 60 Hz.

Press ENTER key to edit parameter. Pressing UP or DOWN key will increment or decrement digit value resp. Then pressing ENTER key will advance to next digit & confirm newly changed values.

SYSTEMTYPE

SYSTEM TYPE :

This parameter is settable as 1 phase or 3 phase. for 3 phase option all powers get multiplied by 3

Press ENTER key to edit parameter. Press UP or DOWN key to get available options (1PH /3PH) resp. Then pressing ENTER key will confirm newly changed option.

INPUT PHASE CURRENT

INPUT PHASE VOLTAGE

INPUT PHASE CURRENT / VOLTAGE :

This parameters are used for phase correction between voltage and current in the measuring system.

Theses settings are applicable if PHASE CORR. ANGLE option in basic settings is set as [USER SETTINGS]

first set phase input current then accordingly in next menu set phase voltage as per network connection. Refer below table for configuration. Use UP or DOWN key to scroll options and use ENTER key to confirm selection

Note : This setting is not applicable if PHASE CORR. ANGLE set as [AUTO DETECTED]

Network table

PHASE CURRENT	PHASE VOLTAGE
IL1	L1 - N - 0°
IL1	L1 - L2 - 30°
IL1 (k <-> l)	L2 - N - 60°
IL1	L3 - L2 - 90°
IL1	L3 - N - 120°
IL1	L3 - L1 - 150°
IL1 (k <-> l)	L1 - N - 180°
IL1 (k <-> l)	L1 - L2 - 210°
IL1	L1 - N - 240°
IL1 (k <-> l)	L2 - L3 - 270°
IL1 (k <-> l)	L3 - N - 300°
IL1 (k <-> l)	L3 - L1 - 330°

PHASE CURRENT	PHASE VOLTAGE
IL2	L2 - N - 0°
IL2	L2 - L3 - 30°
IL2 (k <-> l)	L3 - N - 60°
IL2	L1 - L3 - 90°
IL2	L1 - N - 120°
IL2	L1 - L2 - 150°
IL2 (k <-> l)	L2 - N - 180°
IL2 (k <-> l)	L2 - L3 - 210°
IL2	L3 - N - 240°
IL2 (k <-> l)	L3 - L1 - 270°
IL2 (k <-> l)	L1 - N - 300°
IL2 (k <-> l)	L1 - L2 - 330°

PHASE CURRENT	PHASE VOLTAGE
IL3	L3 - N - 0°
IL3	L3 - L1 - 30°
IL3 (k <-> l)	L1 - N - 60°
IL3	L2 - L1 - 90°
IL3	L2 - N - 120°
IL3	L2 - L3 - 150°
IL3 (k <-> l)	L3 - N - 180°
IL3 (k <-> l)	L3 - L1 - 210°
IL3	L1 - N - 240°
IL3 (k <-> l)	L1 - L2 - 270°
IL3 (k <-> l)	L2 - N - 300°
IL3 (k <-> l)	L2 - L3 - 330°

DEMAND INT. TIME

DEMAND INTEGRATION TIME :

This parameter is used to set the period over which current and power readings are to be integrated. The Unit of displayed values is minutes. time is settable as 8,15,20,30 minutes resp.

Press ENTER key to edit parameter.

Pressing UP or DOWN key will increment or decrement digit value resp. Then pressing ENTER key will advance to next digit & confirm newly changed values.

ENERGY UPDATE RATE

ENERGY UPDATE RATE :

This parameter allows user to enter energy update rate in min. Time is settable in range 1 to 60 min resp.

Press ENTER key to edit parameter.

Pressing UP or DOWN key will increment or decrement digit value resp. Then pressing ENTER key will advance to next digit & confirm newly changed values.

ENERGY UNIT

ENERGY UNIT :

This parameter allows user to set energy in terms of Wh / kWh / MWh as per the requirement. Same is applicable to all types of energy.

Press ENTER key to edit parameter.
Pressing UP or DOWN key will scroll between the available options. Then pressing ENTER key will confirm the newly selected option.

ENERGY OVERFLOW
COUNT

ENERGY OVERFLOW COUNT :

This parameter is used for setting maximum energy count after which energy will roll over to zero depending on setting of Wh, KWh & MWh. Count is settable in range 7 to 9.

Press ENTER key to edit parameter.
Pressing UP or DOWN key will increment or decrement digit value resp. Then pressing ENTER key will advance to next digit & confirm newly changed values.

RTC DATE, TIME

RTC DATE, TIME

Date: Allows user to set date.

Time: Allows user to set the time.

Press ENTER key to edit parameter.
Pressing UP or DOWN key will increment or decrement digit value resp. Then pressing ENTER key will advance to next digit & confirm newly changed values.

Note: (optional menu displayed when RTC module is present)

DEFAULT SYSTEM VALUES

DEFAULT SYSTEM VALUES :

This menu allows user to reset PFC to factory default setting.(Refer section 14)

Press ENTER key to edit parameter.

Press UP or DOWN key to get available options. Then press ENTER key to confirm newly changed option.

During factory reset meter will display "WAIT" message on second row then PFC will reset to factory default settings.

Note : - Resetting to factory default setting APFC will initialize Energy, Demand counters and resets Min / max values.

MAX SWITCH POWER

MAX SWITCH POWER :

This menu allows user to set maximum capacitor bank kVAR switching value.

The settable range is from minimum set capacitor bank value upto the sum of total capacitor banks values.

Increments in steps of minimum capacitor bank value.

Press ENTER key to edit parameter.

Press UP or DOWN key to increments OR decrements max switching power in steps of minimum bank kVAR value. Then press ENTER key to confirm newly changed max switching power.

MANUAL SETUP

Section 11.2 :MANUAL SETUP :

This menu allows user to test or set the bank operating mode.

BANK ON / OFF MANUALLY :

This menu allows user to ON / OFF banks set in Auto mode only.

Press ENTER key to ON/OFF Bank manually.

Press UP or DOWN key to get available options as ON / OFF. Then press ENTER to ON / OFF bank manually.

Note : PFC allows to ON / OFF Banks set in Auto mode only. If fault is present PFC does not allow to ON/OFF Banks manually. On exit from manual mode all the banks enter into Auto mode.

MANUAL BANK
OPERATION

SET BANKFUNCTION AS
AUTO / FIXED / FAULTY

BANKS FUNCTION :

This parameter allows to set individual bank operating mode.

Press ENTER key to edit parameter.

Press UP or DOWN key to get available options as AUTO / FIXED / OFF. Then press ENTER to confirm individual bank operating mode.

Auto : Automatic Operation

It is displayed as capacitor symbol if connected.

Fixed : - It is displayed as capacitor symbol with underline. Fixed Capacitor Banks are continuously connected except in fault condition.

Off : - It is displayed as cross symbol. The capacitor banks are permanently disconnected.

ALARM SETUP

Section 11.3 :ALARM SETUP :

This menu allows user to set one out of several alarm related parameters.

Press ENTER key to enter into alarm setup sub menus. Pressing UP or DOWN key will scroll through submenus.

UNDER -VOLTAGE

UNDER VOLTAGE : It is for Under voltage protection when phase voltage goes below the set threshold value.

Press ENTER key to enter into under voltage sub setup. Pressing UP or DOWN key will scroll through submenus.

TRIGGER VALUE
(75 TO 99 %)

TRIGGER VALUE : Value is settable from 75 to 90% of system nominal voltage value.

Press ENTER key to edit trigger value. Pressing UP or DOWN key will increment or decrement digit value. Then pressing ENTER key will advance to next digit & confirm newly changed values.

RELAYACTIVATION

RELAY ACTIVATION : APFC unit allows to activate / deactivate assigned relay.

Press ENTER key to edit option. Press UP or DOWN key to get available options. Then press ENTER key to confirm newly changed option.

Note 1: - If fault occurs PFC will Switch off all banks including fixed banks one after the other with a delay of 1second between the banks when fault occurs.

Note 2: - Relay will reset at 3% of voltage nominal value plus trip value.
Reset point is factory set, not editable.

OVER VOLTAGE

OVER VOLTAGE : It is for over voltage protection against over voltage condition in phase.

Press ENTER key to enter into over voltage sub setup.
Pressing UP or DOWN key will scroll through submenus.

TRIGGER VALUE : Value is settable from 105 to 115% of system nominal voltage value.

TRIGGER VALUE
(105 TO 115 %)

Press ENTER key to edit trigger value.
Pressing UP or DOWN key will increment or decrement digit value. Then pressing ENTER key will advance to next digit & confirm newly changed values.

RELAYACTIVATION

RELAY ACTIVATION : APFC unit allows to activate / deactivate assigned relay.

Press ENTER key to edit option.
Press UP or DOWN key to get available options. Then press ENTER key to confirm newly changed option.

Note : - 1. If fault occurs APFC will Switch off all banks including fixed banks one after the other with a delay of 1sec between the banks when fault occurs.
2. Relay will reset if system voltage is trip value setting minus 2% of voltage nominal value. Reset point is factory

FREQUENCY FAULT

FREQUENCY FAULT : It is for frequency protection against frequency condition in phase.

Press ENTER key to enter into under frequency sub setup. Pressing UP or DOWN key will scroll through submenus.

TRIGGER VALUE : Value is settable from 2 to 10% of system frequency value.

TRIGGER VALUE

(2 - 10 %)

Press ENTER key to edit trigger value.

Pressing UP or DOWN key will increment or decrement digit value. Then pressing ENTER key will advance to next digit & confirm newly changed values.

RELAYACTIVATION

RELAY ACTIVATION : PFC unit allows to activate / deactivate assigned relay.

Press ENTER key to edit option.

Press UP or DOWN key to get available options. Then press ENTER key to confirm newly changed option.

Note : -

1. Frequency fault will occur at nominal frequency minus or plus of trigger point of nominal frequency.
2. If fault occurs PFC will Switch off all banks including fixed banks one after the other with a delay of 1sec between the banks when fault occurs.
3. Relay will reset at 1% of Nominal frequency value plus OR minus trip value resp. Reset point is factory set, not editable.

UNDER CURRENT

UNDER CURRENT : It is for under current protection against under current condition in phase.

Press ENTER key to enter into under current sub setup. Pressing UP or DOWN key will scroll through submenus.

TRIGGER VALUE : Value is settable from 1 to 3% of CT Primary. For example if CT ratio is 500/1A & trigger value is set as 1%, then under current fault will activate if load current falls below 1% of CT Primary.

TRIGGER VALUE

(1 - 3%)

Press ENTER key to edit trigger value. Pressing UP or DOWN key will increment or decrement digit value. Then pressing ENTER key will advance to next digit & confirm newly changed values.

RELAY ACTIVATION

RELAY ACTIVATION : PFC unit allows to activate / deactivate assigned relay.

Press ENTER key to edit option. Press UP or DOWN key to get available options. Then press ENTER key to confirm newly changed option.

Note : - 1. If fault occurs PFC will Switch off all banks including fixed banks one after the other with a delay of 1sec between the banks when fault occurs.
2. Relay will reset at Trip value plus 1% of CT Primary. Reset point is factory set, not editable.

OVER CURRENT

OVER CURRENT : It is for over current protection against over current condition in phase.

Press ENTER key to enter into over current sub setup.
Pressing UP or DOWN key will scroll through submenus.

TRIGGER VALUE : Value is settable from 60 to 120%.
For example if CT ratio is 500/1A & trigger value is set as 110%, then Over current fault will activate if load current exceeds 550A.

TRIGGER VALUE

(60 - 120 %)

Press ENTER key to edit trigger value.
Pressing UP or DOWN key will increment or decrement digit value. Then pressing ENTER key will advance to next digit & confirm newly changed values.

RELAYACTIVATION

RELAY ACTIVATION : PFC unit allows to activate / deactivate assigned relay.

Press ENTER key to edit option.
Press UP or DOWN key to get available options. Then press ENTER key to confirm newly changed option.

Note : - 1. If fault occurs PFC will Switch off all banks including fixed banks one after the other with a delay of 1sec between the banks when fault occurs.
2. Relay will reset at Trip value minus 1% of CT Primary.
Reset point is factory set, not editable.

VOLTAGE THD

VOLTAGE THD : When voltage THD is more than set limit then PFC will operate alarm relay

Press ENTER key to enter into voltage THD sub setup. Pressing UP or DOWN key will scroll through submenus.

TRIGGER VALUE

(1 - 25 %)

TRIGGER VALUE : Value is settable from 1 to 25%.

Press ENTER key to edit trigger value. Pressing UP or DOWN key will increment or decrement digit value. Then pressing ENTER key will advance to next digit & confirm newly changed values.

RELAYACTIVATION

RELAY ACTIVATION : APFC unit allows to activate / deactivate assigned relay.

Press ENTER key to edit option. Press UP or DOWN key to get available options. Then press ENTER key to confirm newly changed option.

Note : - 1. If fault occurs PFC will Switch off all banks including fixed banks one after the other with a delay of 1second.

2. Relay will reset at set trigger value of voltage THD minus 5%.

Reset point is factory set, not editable.

CURRENT THD

CURRENT THD : When current THD is more than set limit then PF controller will operate relay

Press ENTER key to enter into current THD sub setup. Pressing UP or DOWN key will scroll through submenus.

TRIGGER VALUE
(1 -99 %)

TRIGGER VALUE : Value is settable from 1 to 99%.

Press ENTER key to edit trigger value. Pressing UP or DOWN key will increment or decrement digit value. Then pressing ENTER key will advance to next digit & confirm newly changed values.

RELAY ACTIVATION

RELAY ACTIVATION : PFC allows to activate / deactivate assigned relay.

Press ENTER key to edit option. Press UP or DOWN key to get available options. Then press ENTER key to confirm newly changed option.

Note : - 1. If fault occurs APFC will Switch off all banks including fixed banks one after the other with a delay of 1second

2. Relay will reset at set current THD minus 5%. Reset point is factory set, not editable.

TEMPERATURE

Temperature : When cabinet temperature exceeds above the 55 deg celsius PFC displays warning message and if temperature exceeds above 60 deg celsius PFC disconnects all the capacitor banks and activates the relay if enabled.

RELAYACTIVATION

RELAY ACTIVATION : PFC allows to activate / deactivate assigned relay.

Press ENTER key to edit option.

Press UP or DOWN key to get available options. Then press ENTER key to confirm newly changed option.

Note : - 1. If fault occurs PFC will Switch off all banks including fixed banks one after the other with a delay of 1sec between the banks when fault occurs.

2. When temperature regains below the 55 deg celcius the alarm relay gets deactivated and banks switching takes as per requirement

3. The temperature values of 55 and 60 deg celcius is factory set and not editable.

OVER COMPENSATION

OVER COMPENSATION : In Auto mode if all banks are ON (except Fixed banks) and if Diff. to PF exceeds threshold of lower bank KVAR value PFC will activate relay if enabled.

Press ENTER key to enter into over compensation sub setup.

Pressing UP or DOWN key will scroll through

RELAYACTIVATION

RELAY ACTIVATION : PFC allows to activate / deactivate assigned relay.

Press ENTER key to edit option.

Press UP or DOWN key to get available options. Then press ENTER key to confirm newly changed option.

Note : - 1. Relay will reset if Diff. to PF goes below threshold of lower bank kvar value.

OUT OFFBANKS

OUT OF BANKS : In Auto mode if all banks are ON and still target PF is not achieved PFC will operate relay if activated.

Press ENTER key to enter into OUT OF BANK sub setup.

Pressing UP or DOWN key will scroll through

RELAYACTIVATION

RELAY ACTIVATION : PFC allows user to activate / deactivate assigned relay.

Press ENTER key to edit option.

Press UP or DOWN key to get available options. Then press ENTER key to confirm newly changed option.

Note : - Relay will reset if target PF is achieved.

BATT. LOW FAULT

BATT. LOW FAULT : - (* Applicable for RTC module.)

If the internal Lithium coin Battery Voltage drops down, APFC will show "BAT" (low RTC battery) message on the system warning screen (Display Parameters) until the battery is replaced by a new healthy battery. It is essential to have the battery operational to maintain the Real Time Clock and Calendar information specifically during supply power down condition.

User can enable / disable battery low fault message. Press ENTER key to edit option.

Press UP or DOWN key to get available options (Yes / No). Then press ENTER key to confirm newly changed

BANK SWITCHING
COUNT WARNING

BANK SWITCHING COUNT WARNING : -IF count crosses the set Capacitor switching count APFC gives warning only on display. If user resets the count that particular bank warning will disappear. By default warning is enabled.

BANK HEALTH
WARNING

BANK HEALTH WARNING : -The kvar value of the particular capacitor bank is calculated during each switching operation and compared with set bank value of capacitor. If the result is below the 80% of set bank value health warning will be displayed.

Section 11.4 : RESET VALUES :

This menu allows user to reset one out of several parameters.

RESET VALUES

Press ENTER key to enter into reset values sub menus. Pressing UP or DOWN key will scroll through submenus.

RESETENERGY

RESET ENERGY : Press ENTER key to reset all energy related parameters.

After resetting PFC will show "DONE" message on display.

RESET DEMAND

RESET DEMAND : Press ENTER key to reset all demand related parameters.

After resetting PFC will show "DONE" message on display.

RESETMIN PARA

RESET MINIMUM PARAMETERS : Pressing ENTER key will reset minimum voltage, current, frequency, temperature parameters.

After resetting PFC will show "DONE" message on display.

RESET MAX PARA

RESET MAXIMUM PARAMETERS : Pressing ENTER key will reset maximum voltage, current, frequency, temperature voltage THD, current THD, import power, export power, capacitive power, inductive power, apparent power parameters.

After resetting PFC will show "DONE" message on display.

RESET ON-RUN
HOUR

RESET ON - RUN HOUR : Press ENTER key to reset run hour, on hour.

After resetting PFC will show "DONE" message on display.

RESET INTERRUPT

RESET INTERRUPT : Press ENTER key to reset power down interrupt count.

After resetting PFC will show "DONE" message on display.

RESET BANK SWITCHING
COUNT (INDIVIDUAL/ ALL)

RESET BANK SWITCHING COUNT : Press ENTER key to entered into submenus. Then press UP or DOWN key get available options. Then pressed ENTER key to reset individual, all bank switching count.

After resetting PFC will show "DONE" message on display.

RESET BANK OPERATION
TIME (INDIVIDUAL/ ALL)

RESET BANK OPERATION TIME : Press ENTER key to entered into submenus.. Then press UP or DOWN key get available options. Then pressed ENTER key to reset individual, all bank operation count.

After resetting PFC will show "DONE" message on display.

MODBUS SETUP

Section 11.5 : MODBUS SETUP :

This menu allows user to set modbus related setup.

Press ENTER key to enter into modbus setup sub menus.
Pressing UP or DOWN key will scroll through submenus.

BAUD RATE

BAUD RATE : Press ENTER key to edit baud rate.

Press UP or DOWN key to get available options. Then pressing ENTER key will confirm newly changed values.
Value are settable as 4.8k, 9.8k, 19.2k, 38.4k, 57.6kpbs.

PARITY

PARITY : Press ENTER key to edit parity.

Press UP or DOWN key to get available options. Then pressing ENTER key will confirm newly changed parity.
parity are settable as none, even, odd.

STOPBITS

STOP BITS : Press ENTER key to edit stop bits.

Press UP or DOWN key to get available options. Then pressing ENTER key will confirm newly changed values.
stop bits are settable as 1 or 2.

DEVICE ADDRESS

DEVICE ADDRESS : It allows to set RS 485 address for PFC.

Address are settable in range 1 to 247.

Press ENTER key to edit device address.

Pressing UP or DOWN key will increment or decrement digit value resp. Then pressing ENTER key will advance to next digit & confirm newly changed values.

Section 11.6 : DISPLAY SETUP :

DISPLAY SETUP

This menu allows user to set display related submenus.

Press ENTER key to enter into display setup sub menus.
Pressing UP or DOWN key will scroll through submenus.

LCD BACKLIGHT

LCD BACKLIGHT : PFC allows to ON / OFF LCD backlight. If backlight is set to off mode, APFC unit will switch off backlight after 30 Sec. During editing period backlight will get switch on & remained ON for next 30 Sec.

AUTOSCROLL

AUTOSCROLL: APFC unit allows to enable / disable screen scrolling. Press ENTER key to edit autoscroll mode.
Press UP or DOWN key to get available options. Then pressing ENTER key will confirm newly changed autoscroll

CONTRAST

CONTRAST: APFC unit allows to set LCD contrast. It is settable in range 1 to 9.
Press ENTER key to edit LCD contrast.
Pressing UP or DOWN key will increment or decrement digit value. Then pressing ENTER key will advance to next digit & confirm newly changed contrast.

CHANGE PASSWORD

Section 11.7 :CHANGE PASSWORDS:

To change Basic setting's password and Advanced setting's password enter correct password of Advanced Setting.

After entering Advanced Setting's correct password, PFC enters into advanced setting's sub-menus.

Pressing UP or DOWN key will scroll through Advanced setting's sub-menus. Select "CHANGE PASSWORDS" sub-menu, Press ENTER key to enter into Change Password's sub menus. Pressing UP or DOWN key will scroll through Basic password, Advanced Password menu.

BASIC PASSWORD

BASIC PASSWORD:

Press ENTER key to edit basic password.

Pressing UP or DOWN key will increment or decrement digit value. Then pressing ENTER key will advance to next digit & confirm newly changed password.

To re-edit password, follow the same procedure as mentioned.

ADVANCE PASSWORD

ADVANCE PASSWORD:

Press ENTER key to edit advanced password.

Pressing UP or DOWN key will increment or decrement digit value. Then pressing ENTER key will advance to next digit & confirm newly changed password.

To re-edit password, follow the same procedure as mentioned.

Section 12 : SERVICE MODE :

Press ENTER key to entered into service sub menus.
Pressing UP or DOWN key will scroll through submenus.

The following sub menus will be available in service sub menu : -

1. V -MIN V-MAX
2. I -MIN I -MAX
3. Frequency- MIN MAX
4. Temperature Min MAX
5. Maximum V THD I THD
6. Maximum Import Active power
7. Maximum Export Active power
8. Maximum Capacitive power
9. Maximum Inductive power
10. Maximum Apparent power
11. Maximum Import demand
12. Maximum Export demand
13. Maximum Apparent demand
14. Maximum Ampere demand
15. C1 to C8* Switching count
16. C1 to C8* Operation time
17. C1 to C8*

- Auto Initialization detected capacitor KVAR value
- 18 TEST RUN
 - 19.SHOW FAULT LOG

* As per configuration (Maximum relay can be 8)

TEST RUN:

This menu point allows the user to check the settings of the PFC controller. After activation of the test run, PFC checks if any fault condition present then message will be displayed as INPUT FAULT TESTRUN ABORTED

For fault condition banks are not switched ON.

PFC switches each stage on and off successively and calculates the output of the capacitors connected (this procedure is done three times to eliminate possible errors).

kvar of capacitor bank can be seen while test run in process.

Any discrepancies in bank parameters found are evaluated and displayed in plain text.

The following errors can be displayed:

UNSTABLE LOAD

CHECK CAPACITOR POWER!!!

CHECK CAPACITOR COUNT

Note: The results displayed are messages intended to help the user trace the cause of the error. Final evaluation remains the responsibility of the user. Under complicated (high load fluctuations) grid conditions, 100% error recognition cannot be guaranteed.

Section 13 : TECHNICAL DATA :

Display	<ul style="list-style-type: none">- Large and multifunctional LCD (2 × 16 characters)- Graphic and alphanumeric- LCD illumination
System parameters displayed	<ul style="list-style-type: none">- Line voltage (V AC)- Reactive power (VAr)- Active power (W)- Frequency (Hz)- Apparent power (VA)- Line current (A)- Temperature (°C)- Real-time cos phi- Diff to PF- THD – V / THD - I in % upto 31st- Individual Harmonics in % upto 31st for V & I- Energy kWh (Import/ Export)- Energy kVAh- Energy kVARh (Ind /Cap)- Demand kVA/Current/kW (Imp / Exp)- Run Hour- On Hour- No of interruption- RTC time.- System Fault 1/2.- System Warning

Alarm output	<ul style="list-style-type: none">- Out of Bank (Under Compensation)- Overcompensation- Under Voltage- Over Voltage- Undercurrent- Overcurrent- Over temperature- Under / Over Frequency- Excess Harmonics (V-THD / I- THD)
Recall recorded values	<ul style="list-style-type: none">- Maximum / Minimum Voltage- Maximum / Minimum Current- Maximum / Minimum Frequency- Maximum Active Power (Import / Export)- Maximum Apparent Power- Maximum Capacitive Power- Maximum Inductive Power- Maximum Active Import Demand- Maximum Active Export Demand- Maximum Apparent Demand- Maximum Ampere Demand- Maximum / Minimum Temperature- Maximum THD(V/I)- Switching count of Capacitor- Operation time of capacitor

Warning Messages	<ul style="list-style-type: none"> - Capacitor switching count exceed the limit (OSC - Over Switching Count) - Capacitor kVAR value between 70 to 80% (CVAl) - Ambient temperature between 55 to 60 Degree Cel. (TMP) - RTC Battery Low (BAT) (Only applicable for RTC module)
Weight	0.35 kg
Dimensions	<p>Panel-mounted 96 × 96 × 51 mm (Back Depth 75mm with add on module) (cut out 92 +0.8× 92+0.8 mm)</p>
<p>Ambient conditions</p> <ul style="list-style-type: none"> - Over-voltage class - Pollution degree - Operating temperature - Storage temperature - Sensitivity to EMC - Safety guidelines - Mounting position - Humidity class <p>Protection class</p> <ul style="list-style-type: none"> - Front plate - Rear side 	<p>III 2 -10 ... +60 °C -20 ... +65 °C IEC61326-1:2012 Table-2 IEC 61010-1:2010 Flush Mounting 15% ... 95% non-condensing</p> <p>IP54 to IEC60529 IP20 to IEC60529</p>

<p>Operation</p> <ul style="list-style-type: none"> - Auxiliary Supply voltage - Auxiliary Supply Frequency - Target cos phi - Switching On & Off - Discharge Time Control modes 	<p>110 V AC – 550 V AC 40 to 70 Hz 0.8 ind. ... 0.8 cap. 10 s ... 30 min 60 s ... 30 min self-optimized intelligent control mode</p>
<p>Measurement</p> <ul style="list-style-type: none"> - Measurement voltage range - Fundamental frequency - Measurement current (CT) - Minimum operating current - Maximum current <p>Accuracy</p>	<p>30 ... 550 V AC (L-L / L-N) 50 / 60 Hz x/5 and x/1 Ampere onsite programmable 2 mA 6 A (sinusoidal) Current, voltage: 0.5% of nominal value Active, Apparent, Reactive power: 1% of nominal value Active Energy : 1% Apparent Energy : 1% Reactive Energy : 2% THD : ± 4%</p>
<p>Switching outputs</p> <p>Relay outputs</p> <ul style="list-style-type: none"> - Number of outputs - Switching voltage/Power 	<p>4/6/8 steps available Max. 250 VAC / 1000W</p>
<p>Alarm relay</p>	<p>Potential-free contact (Max. 250 VAC / 1000W)</p>

Section 14 : FACTORY DEFAULT SETTING :

Description	Default value
System Nominal Voltage	240 VLN
CT Primary	1000 Amp
CT Seconadry	5 Amp
System frequency	50 Hz
System type	3 Phase
PHASE I (refer flow chart)	IL 1
PHASE V (refer flow chart)	VL 1 - N - 0°
Demand integration time	8 Min
Energy unit	kWh, KVArh, KVAh
Energy Rate	1 Min
Energy Overflow Count	8
Node address	1
Rs485 setup code	9600, none, 2
PHASE CORR. ANGLE	USER SETTINGS
CAPACITOR KVAr	DIRECT KVAr

Section 14 : FACTORY DEFAULT SETTING :

Basic Password	0000
Advanced Password	0001
Autoscroll	OFF
Backlite ON/OFF	ON
Contrast level	5
Target power factor	0.995 Ind
Banks in use	4
Maximum Switching Power	25 kVAr
Capacitor bank 1 kvar	25
Capacitor bank 2 kvar	25
Capacitor bank 3 kvar	25
Capacitor bank 4 kvar	25
AUTO INIT	NO
CONTROL SERIES	1

Depending on model number of capacitor bank count changes max is 8

Description	Default value
Bank switching Threshold	66%
Capacitor switch in time	40 Sec
Capacitor switch off time	40 Sec
Capacitor discharge time	60 Sec
Capcitor bank 1 (Auto/Fixed/Faulty)	Auto
Capcitor bank 2 (Auto/Fixed/Faulty)	Auto
Capcitor bank 3 (Auto/Fixed/Faulty)	Auto
Capcitor bank 4 (Auto/Fixed/Faulty)	Auto
C-health test (enable/disable)	Disable
Switch_operation_warning	50000
C Health test count	5

Fault	Description	Default
Under Voltage	Enable Parameter (*)	Enable
	Trip Value	85%
	Trip Delay (*)	5 Sec
	Hysteresis (*)	3%
	Relay	Yes
Over Voltage	Enable Parameter (*)	Enable
	Trip Value	110%
	Trip Delay (*)	5 Sec
	Hysteresis (*)	2%
	Relay	Yes
Under Frequency	Enable Parameter	Disable
	Trip Value	6%
	Trip Delay (*)	5 Sec
	Hysteresis (*)	1%
	Relay	No
Over Frequency	Enable Parameter	Disable
	Trip Value	6%
	Trip Delay (*)	5 Sec
	Hysteresis (*)	1%
	Relay	No

*Note : - Parameters are not editable, Factory set.

Fault	Description	Default
Under Current	Enable Parameter (*)	Enable
	Trip Value	2%
	Trip Delay (*)	5 Sec
	Hysteresis (*)	1%
	Relay	Yes
Over Current	Enable Parameter (*)	Enable
	Trip Value	110%
	Trip Delay (*)	5 Sec
	Hysteresis (*)	1%
	Relay	Yes
V THD	Enable Parameter (*)	Enable
	Trip Value	7%
	Trip Delay (*)	30 Sec
	Hysteresis (*)	5%
	Relay	Yes
I THD	Enable Parameter (*)	Enable
	Trip Value	50%
	Trip Delay (*)	30 Sec
	Hysteresis (*)	5%
	Relay	Yes

*Note : - Parameters are not editable, Factory set.

Fault	Description	Default
Temperature	Enable Parameter (*)	Enable
	Trip Value (*)	60 Degree
	Trip Delay (*)	10 Sec
	Hysteresis (*)	55 Degree
	Relay	Yes
Out Of bank	Enable Parameter (*)	Enable
	Trip Delay (*)	10 Sec
	Relay	Yes
OverCompensation	Enable Parameter (*)	Enable
	Trip Delay (*)	10 Sec
	Relay	Yes

*Note : - Parameters are not editable, Factory set.

Section 15 : OPERATING DIAGRAM :

Menu Key (M)

Enter Key (E)

Up Key (U)

Down Key (D)

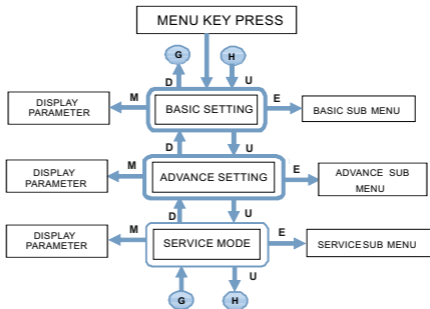

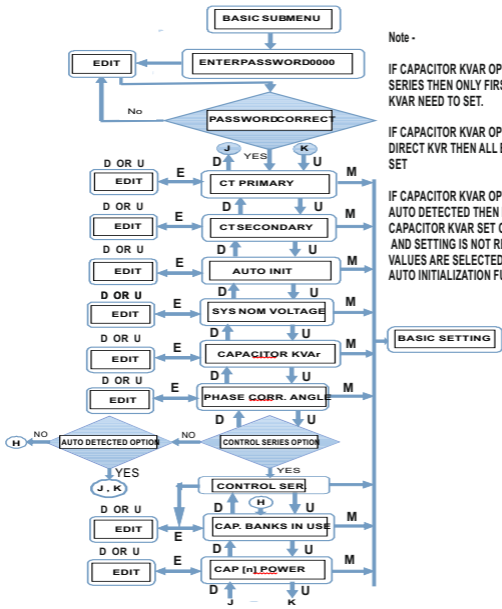

Note -

IF CAPACITOR KVAR OPTION IS CONTROL SERIES THEN ONLY FIRST CAPACITOR BANK KVAR NEED TO SET.

IF CAPACITOR KVAR OPTION SELECTED AS DIRECT KVR THEN ALL BANK KVAR NEED TO SET

IF CAPACITOR KVAR OPTION SELECTED AS AUTO DETECTED THEN BANK IN USE OPTION, CAPACITOR KVAR SET OPTION DISAPPEAR AND SETTING IS NOT REQUIRED BECAUSE VALUES ARE SELECTED FROM AUTO INITIALIZATION FUNCTION

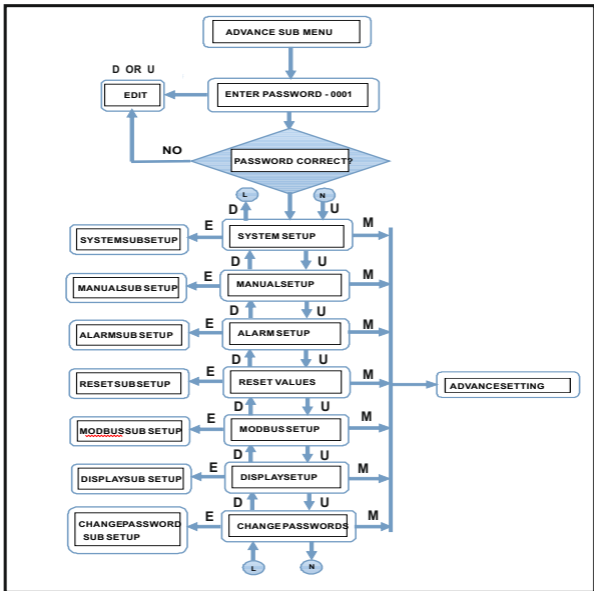

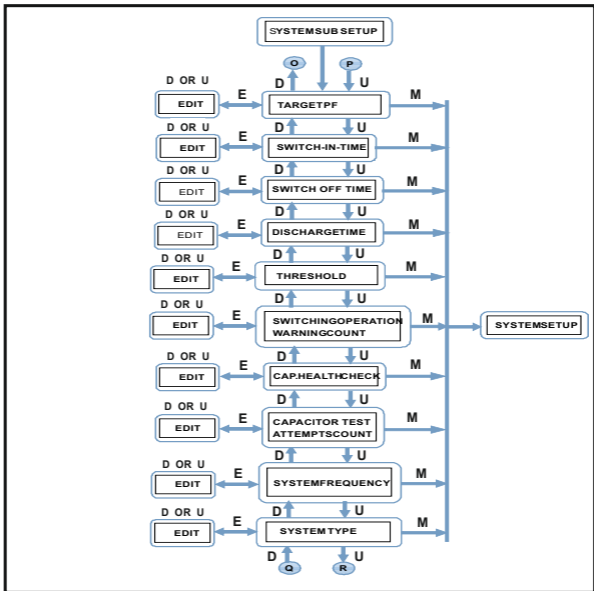

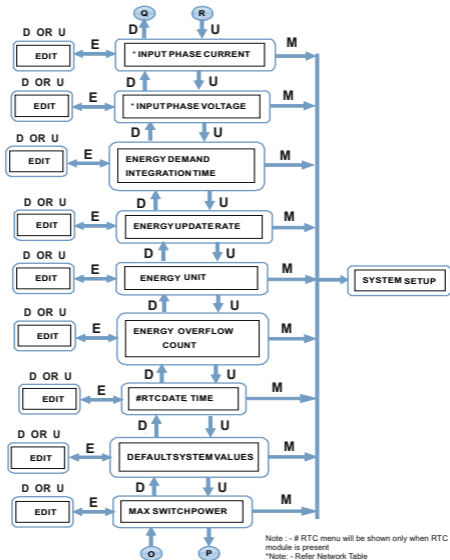

Network Table :-

PHASE CURRENT	PHASE VOLTAGE
IL1	L1 - N - 0°
IL1	L1 - L2 - 30°
IL1 (k <-> l)	L2 - N - 60°
IL1	L3 - L2 - 90°
IL1	L3 - N - 120°
IL1	L3 - L1 - 150°
IL1 (k <-> l)	L1 - N - 180°
IL1 (k <-> l)	L1 - L2 - 210°
IL1	L1 - N - 240°
IL1 (k <-> l)	L2 - L3 - 270°
IL1 (k <-> l)	L3 - N - 300°
IL1 (k <-> l)	L3 - L1 - 330°

PHASE CURRENT	PHASE VOLTAGE
IL2	L2 - N - 0°
IL2	L2 - L3 - 30°
IL2 (k <-> l)	L3 - N - 60°
IL2	L1 - L3 - 90°
IL2	L1 - N - 120°
IL2	L1 - L2 - 150°
IL2 (k <-> l)	L2 - N - 180°
IL2 (k <-> l)	L2 - L3 - 210°
IL2	L3 - N - 240°
IL2 (k <-> l)	L3 - L1 - 270°
IL2 (k <-> l)	L1 - N - 300°
IL2 (k <-> l)	L1 - L2 - 330°

PHASE CURRENT	PHASE VOLTAGE
IL3	L3 - N - 0°
IL3	L3 - L1 - 30°
IL3 (k <-> l)	L1 - N - 60°
IL3	L2 - L1 - 90°
IL3	L2 - N - 120°
IL3	L2 - L3 - 150°
IL3 (k <-> l)	L3 - N - 180°
IL3 (k <-> l)	L3 - L1 - 210°
IL3	L1 - N - 240°
IL3 (k <-> l)	L1 - L2 - 270°
IL3 (k <-> l)	L2 - N - 300°
IL3 (k <-> l)	L2 - L3 - 330°

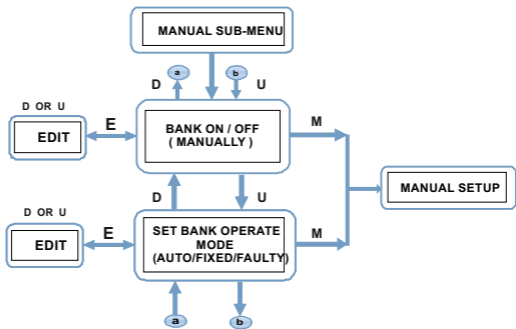

NOTE -

Setting bank mode (Fixed,Faulty,Auto) menu is available when CAPACITOR KVAR OPTION in basic settings is selected as DIRECT KVAR or CONTROL SERIES. If CAPACITOR KVAR OPTION selected as AUTO DETECTED then bank mode option is not available and all capacitor banks are evaluated in auto initialization function.

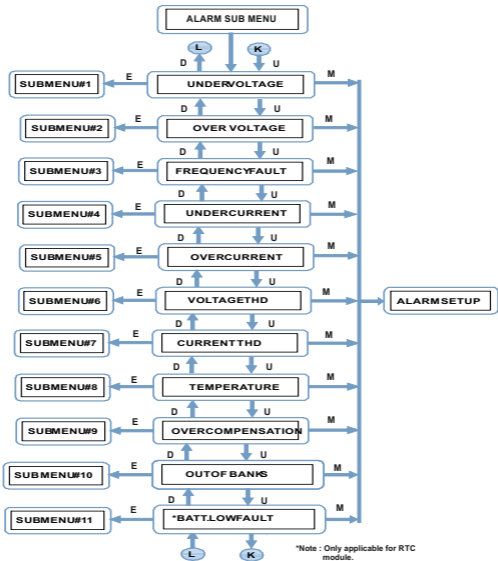

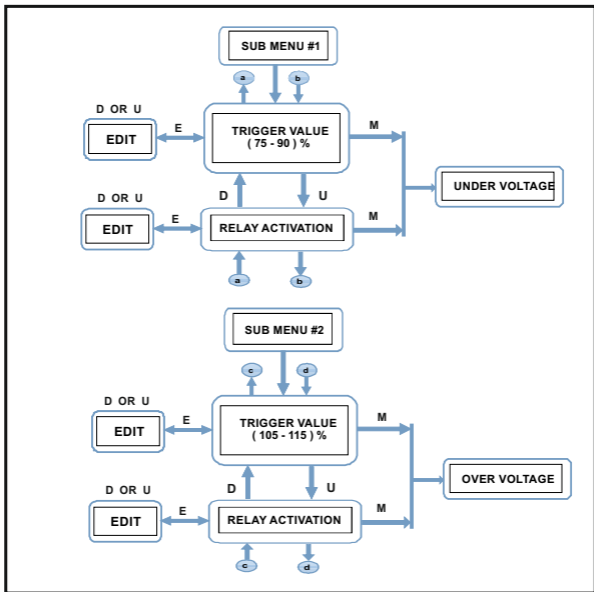

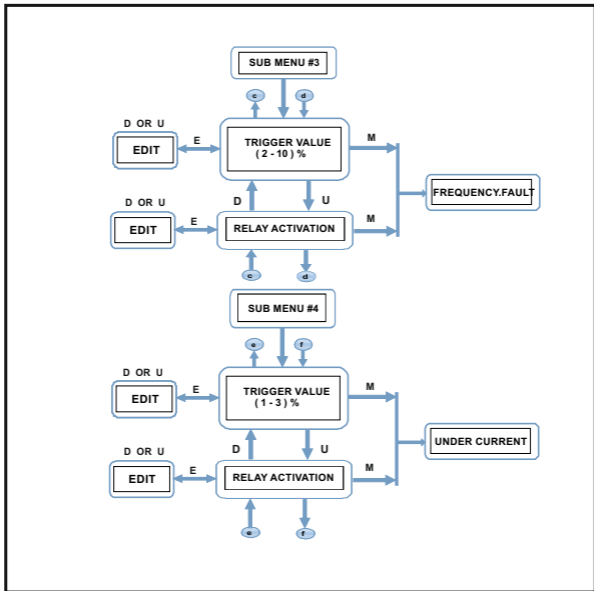

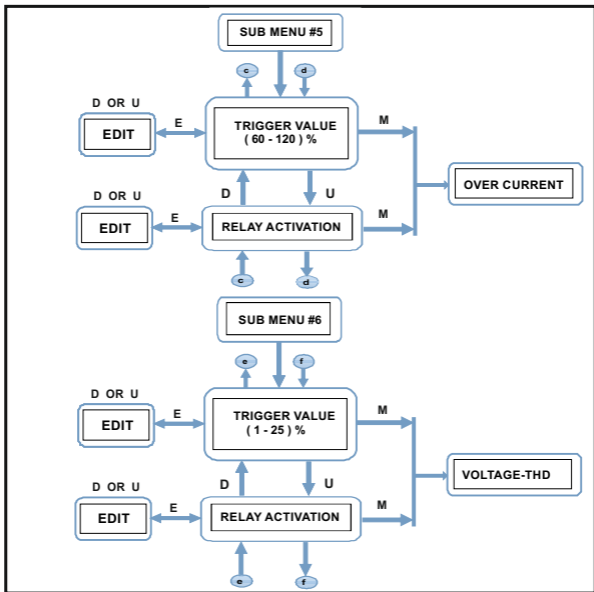

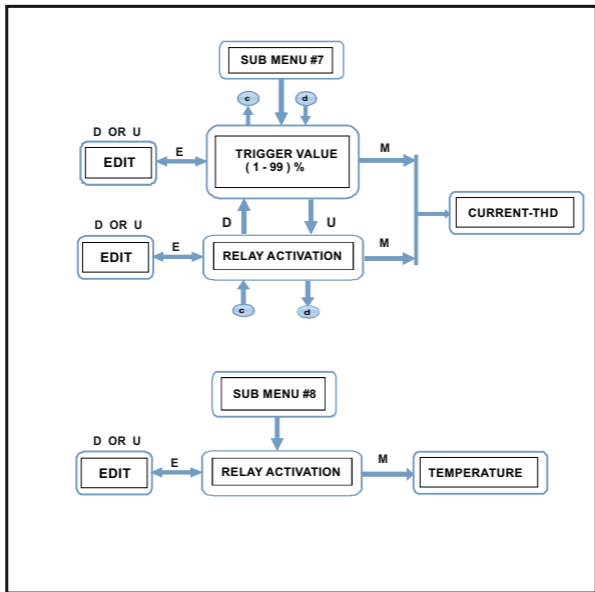

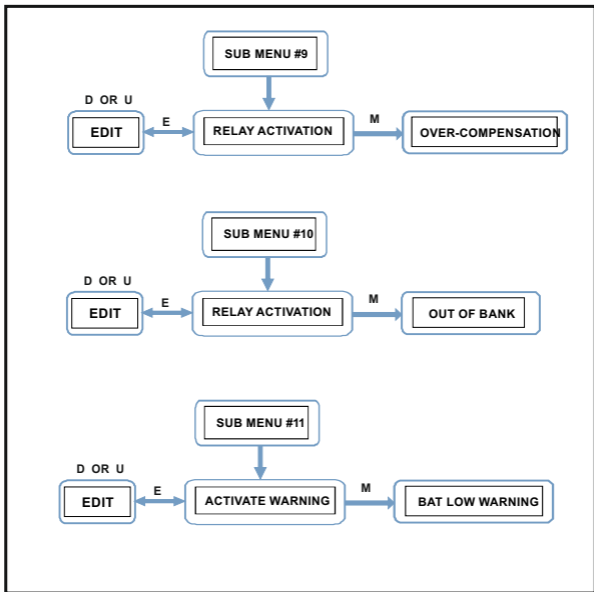

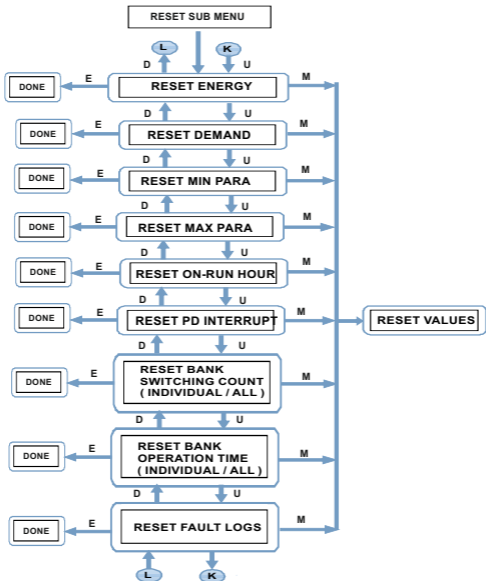

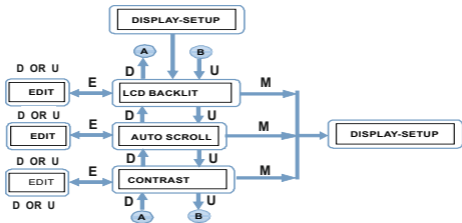
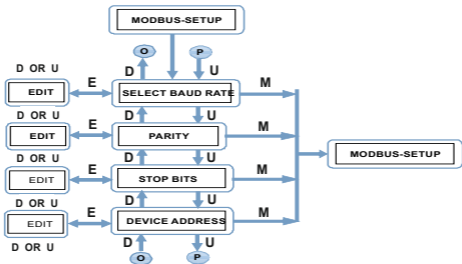

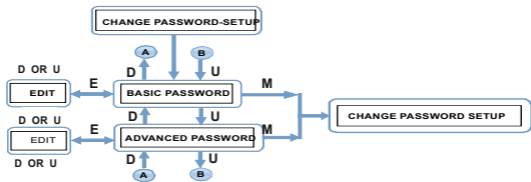

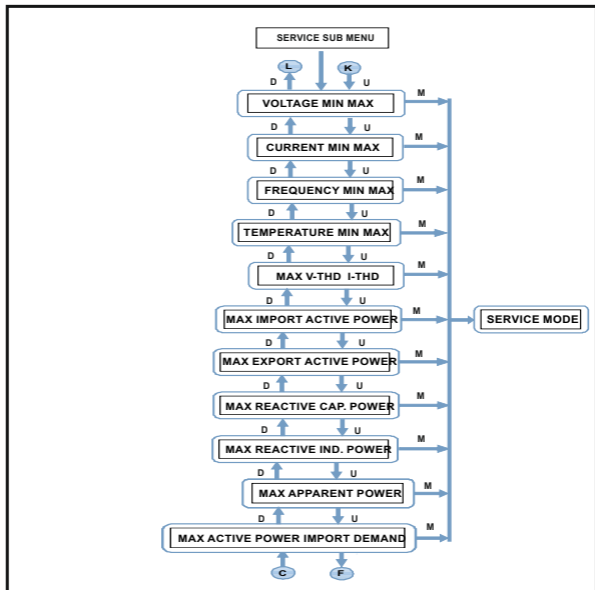

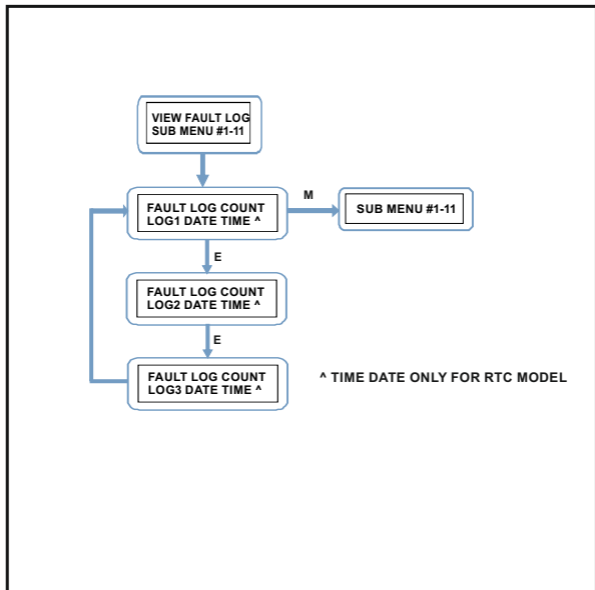

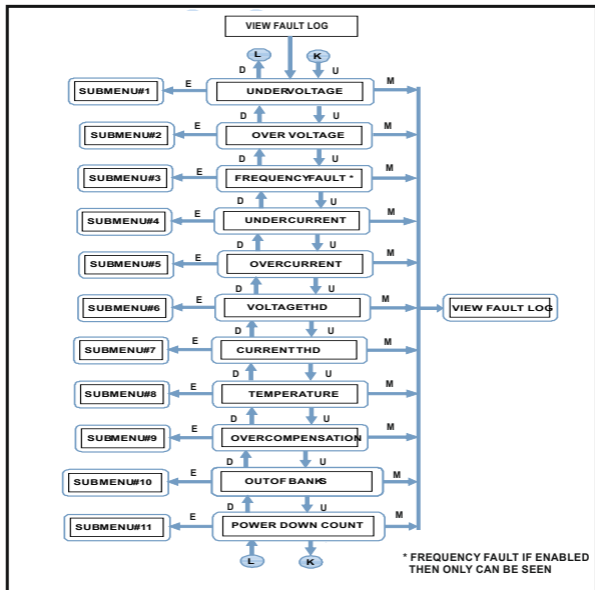

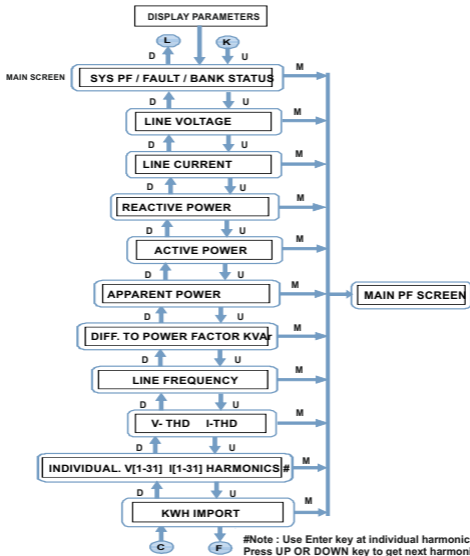

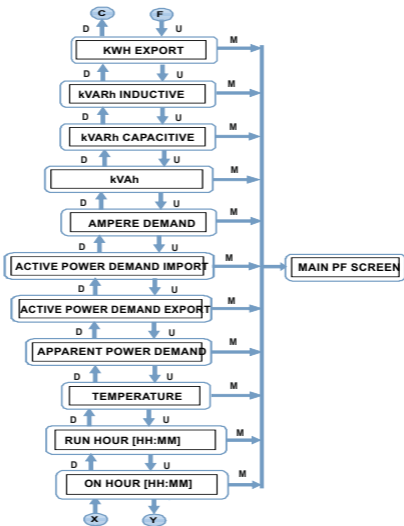

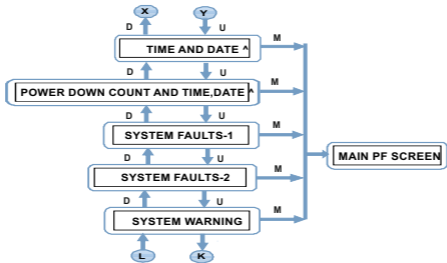

^Note : - Only applicable for RTC module

NOTE